

# TOSHIBA

## Industrial Inverter (For 3-phase induction motors)

---

### Instruction Manual

---

# TOSVERT™ VF-S11

1-phase 240V class	0.2 to 2.2kW
3-phase 240V class	0.4 to 15kW
3-phase 500V class	0.4 to 15kW
3-phase 600V class	0.75 to 15kW

#### NOTICE

1. Make sure that this instruction manual is delivered to the end user of the inverter unit.
2. Read this manual before installing or operating the inverter unit, and store it in a safe place for reference.



E6581158②

Safety precautions	<b>I</b>
Introduction	<b>II</b>
Contents	
Read first	<b>1</b>
Connection	<b>2</b>
Operations	<b>3</b>
Basic VF-S11 operations	<b>4</b>
Basic parameters	<b>5</b>
Extended parameters	<b>6</b>
Applied operation	<b>7</b>
Monitoring the operation status	<b>8</b>
Measures to satisfy the standards	<b>9</b>
Peripheral devices	<b>10</b>
Table of parameters and data	<b>11</b>
Specifications	<b>12</b>
Before making a service call	<b>13</b>
Inspection and maintenance	<b>14</b>
Warranty	<b>15</b>
Disposal of the inverter	<b>16</b>

# I. Safety precautions

The items described in these instructions and on the inverter itself are very important so that you can use the inverter safely, prevent injury to yourself and other people around you as well as to prevent damage to property in the area. Thoroughly familiarize yourself with the symbols and indications shown below and then continue to read the manual. Make sure that you observe all warnings given.





## Explanation of markings

Marking	Meaning of marking
 <b>Danger</b>	Indicates that errors in operation may lead to death or serious injury.
 <b>Warning</b>	Indicates that errors in operation may lead to injury (*1) to people or that these errors may cause damage to physical property. (*2)

(\*1) Such things as injury, burns or shock that will not require hospitalization or long periods of outpatient treatment.

(\*2) Physical property damage refers to wide-ranging damage to assets and materials.

## Meanings of symbols

Marking	Meaning of marking
	Indicates prohibition (Don't do it). What is prohibited will be described in or near the symbol in either text or picture form.
	Indicates something mandatory (must be done). What is mandatory will be described in or near the symbol in either text or picture form.
	Indicates danger. What is dangerous will be described in or near the symbol in either text or picture form.
	Indicates warning. What the warning should be applied to will be described in or near the symbol in either text or picture form.

## ■ Limits in purpose





This inverter is used for controlling speeds of three-phase induction motors in general industrial use.





### Safety precautions



- ▼ The inverter cannot be used in any device that would present danger to the human body or from which malfunction or error in operation would present a direct threat to human life (nuclear power control device, aviation and space flight control device, traffic device, life support or operation system, safety device, etc.). If the inverter is to be used for any special purpose, first get in touch with the supplier.
- ▼ This product was manufactured under the strictest quality controls but if it is to be used in critical equipment, for example, equipment in which errors in malfunctioning signal output system would cause a major accident, safety devices must be installed on the equipment.
- ▼ Do not use the inverter for loads other than those of properly applied three-phase induction motors in general industrial use. (Use in other than properly applied three-phase induction motors may cause an accident.)



■ General Operation

 <b>Danger</b>		See item
 Disassembly prohibited	<ul style="list-style-type: none"> <li>Never disassemble, modify or repair. This can result in electric shock, fire and injury. For repairs, call your sales distributor.</li> </ul>	2.
 Prohibited	<ul style="list-style-type: none"> <li>Never remove the front cover when power is on or open door if enclosed in a cabinet. The unit contains many high voltage parts and contact with them will result in electric shock.</li> <li>Don't stick your fingers into openings such as cable wiring hole and cooling fan covers. This can result in electric shock or other injury.</li> <li>Don't place or insert any kind of object into the inverter (electrical wire cuttings, rods, wires etc.). This can result in electric shock or fire.</li> <li>Do not allow water or any other fluid to come in contact with the inverter. This can result in electric shock or fire.</li> </ul>	2.1 2. 2. 2.
 Mandatory	<ul style="list-style-type: none"> <li>Turn power on only after attaching the front cover or closing door if enclosed in a cabinet. If power is turned on without the front cover attached or closing door if enclosed in a cabinet, this can result in electric shock or other injury.</li> <li>If the inverter begins to emit smoke or an unusual odor, or unusual sounds, immediately turn power off. If the equipment is continued in operation in such a state, the result may be fire. Call your local sales agency for repairs.</li> <li>Always turn power off if the inverter is not used for long periods of time since there is a possibility of malfunction caused by leaks, dust and other material. If power is left on with the inverter in that state, it may result in fire.</li> </ul>	2.1 3. 3.



 <b>Warning</b>		See item															
 Prohibited contact	<ul style="list-style-type: none"> <li>Do not touch heat radiating fins or discharge resistors. These device are hot, and you'll get burned if you touch them.</li> </ul>	3.															
 Prohibited	<ul style="list-style-type: none"> <li>Avoid operation in any location where there is direct spraying of the following solvents or other chemicals. The plastic parts may be damaged to a certain degree depending on their shape, and there is a possibility of the plastic covers coming off. If the chemical or solvent is anything other than those shown below, please contact us in advance.</li> </ul> <div style="display: flex; justify-content: space-between;"> <div style="width: 45%;"> <p>(Table 1) Examples of applicable chemicals and solvents</p> <table border="1" style="width: 100%; border-collapse: collapse;"> <tr><td>Acetic acid (density of 10% or less)</td></tr> <tr><td>Hydrochloric acid (density of 10% or less)</td></tr> <tr><td>Sulfuric acid (density of 10% or less)</td></tr> <tr><td>Sodium chloride</td></tr> <tr><td>Hexane</td></tr> <tr><td>Triethylene glycol</td></tr> </table> </div> <div style="width: 45%;"> <p>(Table 2) Examples of unapplicable chemicals and solvents</p> <table border="1" style="width: 100%; border-collapse: collapse;"> <tr><td>Acetone</td></tr> <tr><td>Benzene</td></tr> <tr><td>Chloroform</td></tr> <tr><td>Ethylene chloride</td></tr> <tr><td>Ethyl acetate</td></tr> <tr><td>Glycerin</td></tr> <tr><td>Tetrachloroethylene</td></tr> <tr><td>Trichloroethylene</td></tr> <tr><td>Xylene</td></tr> </table> </div> </div>	Acetic acid (density of 10% or less)	Hydrochloric acid (density of 10% or less)	Sulfuric acid (density of 10% or less)	Sodium chloride	Hexane	Triethylene glycol	Acetone	Benzene	Chloroform	Ethylene chloride	Ethyl acetate	Glycerin	Tetrachloroethylene	Trichloroethylene	Xylene	1.4.4
Acetic acid (density of 10% or less)																	
Hydrochloric acid (density of 10% or less)																	
Sulfuric acid (density of 10% or less)																	
Sodium chloride																	
Hexane																	
Triethylene glycol																	
Acetone																	
Benzene																	
Chloroform																	
Ethylene chloride																	
Ethyl acetate																	
Glycerin																	
Tetrachloroethylene																	
Trichloroethylene																	
Xylene																	

## ■ Transportation & installation



 <b>Danger</b>		See item
 Prohibited	<ul style="list-style-type: none"> <li>Do not install or operate the inverter if it is damaged or any component is missing. This can result in electric shock or fire. Please consult your local sales agency for repairs. Call your local sales agency for repairs.</li> <li>Do not place any inflammable objects nearby. If a flame is emitted due to malfunction, it may result in a fire.</li> <li>Do not install in any location where the inverter could come into contact with water or other fluids. This can result in electric shock or fire.</li> </ul>	1.4.4 1.4.4 2.
 Mandatory	<ul style="list-style-type: none"> <li>Must be used in the environmental conditions prescribed in the instruction manual. Use under any other conditions may result in malfunction.</li> <li>Mount the inverter on a metal plate. The rear panel gets very hot. Do not install in an inflammable object, this can result in fire.</li> <li>Do not operate with the front panel cover removed. This can result in electric shock. Failure to do so can lead to risk of electric shock and can result in death or serious injury.</li> <li>An emergency stop device must be installed that fits with system specifications (e.g. shut off input power then engage mechanical brake). Operation cannot be stopped immediately by the inverter alone, thus risking an accident or injury.</li> <li>All options used must be those specified by Toshiba. The use of any other option may result in an accident.</li> </ul>	1.4.4 1.4.4 1.4.4 1.4.4 1.4.4



 <b>Warning</b>		See item
 Prohibited	<ul style="list-style-type: none"> <li>When transporting or carrying, do not hold by the front panel covers. The covers may come off and the unit will drop out resulting in injury.</li> <li>Do not install in any area where the unit would be subject to large amounts of vibration. That could result in the unit falling, resulting in injury.</li> </ul>	2. 1.4.4
 Mandatory	<ul style="list-style-type: none"> <li>The main unit must be installed on a base that can bear the unit's weight. If the unit is installed on a base that cannot withstand that weight, the unit may fall resulting in injury.</li> <li>If braking is necessary (to hold motor shaft), install a mechanical brake. The brake on the inverter will not function as a mechanical hold, and if used for that purpose, injury may result.</li> </ul>	1.4.4 1.4.4

## ■ Wiring



 <b>Danger</b>		See item
 Prohibited	<ul style="list-style-type: none"> <li>Do not connect input power to the output (motor side) terminals (U/T1,V/T2,W/T3). That will destroy the inverter and may result in fire.</li> <li>Do not connect resistors to the DC terminals (across PA-PC or PO-PC). That may cause a fire. Connect a resistor in accordance with 6.13.4.</li> <li>Within ten minutes after turning off input power, do not touch wires of devices (MCCB) connected to the input side of the inverter. That could result in electric shock.</li> </ul>	2.2 2.2 2.2



I

 <b>Danger</b>		See item
 Mandatory	<ul style="list-style-type: none"> <li>Electrical installation work must be done by a qualified expert. Connection of input power by someone who does not have that expert knowledge may result in fire or electric shock.</li> </ul>	2.1
	<ul style="list-style-type: none"> <li>Connect output terminals (motor side) correctly. If the phase sequence is incorrect, the motor will operate in reverse and that may result in injury.</li> </ul>	2.1
	<ul style="list-style-type: none"> <li>Wiring must be done after installation. If wiring is done prior to installation that may result in injury or electric shock</li> </ul>	2.1
	<ul style="list-style-type: none"> <li>The following steps must be performed before wiring.               <ol style="list-style-type: none"> <li>Turn off all input power.</li> <li>Wait at least ten minutes and check to make sure that the charge lamp is no longer lit.</li> <li>Use a tester that can measure DC voltage (800VDC or more), and check to make sure that the voltage to the DC main circuits (across PA-PC) is 45V or less. If these steps are not properly performed, the wiring will cause electric shock.</li> </ol> </li> </ul>	2.1
	<ul style="list-style-type: none"> <li>Tighten the screws on the terminal board to specified torque. If the screws are not tightened to the specified torque, it may lead to fire.</li> <li>Check to make sure that the input power voltage is +10%, -15% of the rated power voltage written on the rating label (<math>\pm 10\%</math> when the load is 100% in continuous operation). If the input power voltage is not +10%, -15% of the rated power voltage (<math>\pm 10\%</math> when the load is 100% in continuous operation) this may result in fire.</li> </ul>	2.1 1.4.4
 Be Grounded	<ul style="list-style-type: none"> <li>Ground must be connected securely. If the ground is not securely connected, it could lead to electric shock or fire when a malfunction or current leak occurs.</li> </ul>	2.1 2.2



 <b>Warning</b>		See item
 Prohibited	<ul style="list-style-type: none"> <li>Do not attach equipment (such as noise filters or surge absorbers) that have built-in capacitors to the output (motor side) terminals. That could result in a fire.</li> </ul>	2.1

## ■ Operations



 <b>Danger</b>		See item
 Prohibited	<ul style="list-style-type: none"> <li>Do not touch inverter terminals when electrical power is going to the inverter even if the motor is stopped. Touching the inverter terminals while power is connected to it may result in electric shock.</li> <li>Do not touch switches when the hands are wet and do not try to clean the inverter with a damp cloth. Such practices may result in electric shock.</li> <li>Do not go near the motor in alarm-stop status when the retry function is selected. The motor may suddenly restart and that could result in injury. Take measures for safety, e.g. attaching a cover to the motor, against accidents when the motor unexpectedly restarts.</li> </ul>	3. 3. 3.
 Mandatory	<ul style="list-style-type: none"> <li>Turn input power on after attaching the front cover. When installed inside a cabinet and using with the front cover removed, always close the cabinet doors first and then turn power on. If the power is turned on with the front cover or the cabinet doors open, it may result in electric shock.</li> <li>Make sure that operation signals are off before resetting the inverter after malfunction. If the inverter is reset before turning off the operating signal, the motor may restart suddenly causing injury.</li> </ul>	3. 3.

 <b>Warning</b>		See item
 Prohibited	<ul style="list-style-type: none"> <li>Observe all permissible operating ranges of motors and mechanical equipment. (Refer to the motor's instruction manual.) Not observing these ranges may result in injury.</li> </ul>	3.



When sequence for restart after a momentary failure is selected (inverter)

 <b>Warning</b>		See item
 Mandatory	<ul style="list-style-type: none"> <li>Stand clear of motors and mechanical equipment. If the motor stops due to a momentary power failure, the equipment will start suddenly after power recovers. This could result in unexpected injury.</li> <li>Attach warnings about sudden restart after a momentary power failure on inverters, motors and equipment for prevention of accidents in advance.</li> </ul>	6.12.1  6.12.1



When retry function is selected (inverter)

 <b>Warning</b>		See item
 Mandatory	<ul style="list-style-type: none"> <li>Stand clear of motors and equipment. If the motor and equipment stop when the alarm is given, selection of the retry function will restart them suddenly after the specified time has elapsed. This could result in unexpected injury.</li> <li>Attach warnings about sudden restart in retry function on inverters, motors and equipment for prevention of accidents in advance.</li> </ul>	6.12.3  6.12.3

Maintenance and inspection

 <b>Danger</b>		See item
 Prohibited	<ul style="list-style-type: none"> <li>Do not replace parts. This could be a cause of electric shock, fire and bodily injury. To replace parts, call the local sales agency.</li> </ul>	14.2
 Mandatory	<ul style="list-style-type: none"> <li>The equipment must be inspected every day. If the equipment is not inspected and maintained, errors and malfunctions may not be discovered and that could result in accidents.</li> <li>Before inspection, perform the following steps.                             <ol style="list-style-type: none"> <li>Turn off all input power to the inverter.</li> <li>Wait at least ten minutes and check to make sure that the charge lamp is no longer lit.</li> <li>Use a tester that can measure DC voltages (800VDC or more), and check to make sure that the voltage to the DC main circuits (across PA-PC) is 45V or less.</li> </ol>                             If inspection is performed without performing these steps first, it could lead to electric shock.                         </li> </ul>	14.  14.

## Disposal

 Warning		See item
 Mandatory	<ul style="list-style-type: none"> <li>• If you throw away the inverter, have it done by a specialist in industry waste disposal(*). If you throw away the inverter by yourself, this can result in explosion of capacitor or produce noxious gases, resulting in injury.</li> <li>(* ) Persons who specialize in the processing of waste and known as "industrial waste product collectors and transporters" or "industrial waste disposal persons." If the collection, transport and disposal of industrial waste is done by someone who is not licensed for that job, it is a punishable violation of the law. (Laws in regard to cleaning and processing of waste materials)</li> </ul>	16.

## Attach warning labels

Shown here are examples of warning labels to prevent, in advance, accidents in relation to inverters, motors and other equipment.

Be sure to affix the caution label where it is easily visible when selecting the auto-restart function (6.13.1) or the retry function (6.13.3).

If the inverter has been programmed for restart sequence of momentary power failure, place warning labels in a place where they can be easily seen and read.  
(Example of warning label)

	<b>Warning (Functions programmed for restart)</b>
Do not go near motors and equipment. Motors and equipment that have stopped temporarily after momentary power failure will restart suddenly after recovery.	

If the retry function has been selected, place warning labels in a location where they can be easily seen and read.  
(Example of warning label)

	<b>Warning (Functions programmed for retry)</b>
Do not go near motors and equipment. Motors and equipment that have stopped temporarily after an alarm will restart suddenly after the specified time has elapsed.	

## II. Introduction

---

Thank you for your purchase of the Toshiba "TOSVERT VF-S11" industrial inverter.

This is the Ver.108 / Ver.109 CPU version inverter.  
Please be informed that CPU version will be frequently upgraded.

### ■ Features

#### 1. Built-in noise filter

- 1) All models in both the 240V and 500V series have a noise filter inside. (Except 600V series)
- 2) Can be compliant with European CE marking standard
- 3) Reduces space requirements and cuts down on time and labor needed in wiring.

#### 2. Simple operation

- 1) Automatic functions (torque boost acceleration/deceleration time, function programming)  
Just by wiring the motor to the power supply allows instant operation without the need to program parameters.
- 2) The potentiometer dial and the RUN/STOP button allow easy operation.

#### 3. Superior basic performance

- 1) 200% or more starting torque
- 2) Smooth operation : Reduced rotation ripple through the use of Toshiba's unique waveform formation.
- 3) Built-in current surge suppression circuit : Can be safely connected even if power load is low.
- 4) Maximum 500Hz high frequency output : Optimum for use with high speed motors such as those in lumber machinery and milling machines.
- 5) Maximum carrier frequency : 16kHz quiet operation  
Toshiba's unique PWM control reduces noise at low carrier.

#### 4. Globally compatible

- 1) Compatible with 240V, 500V and 600V power supplies
- 2) Conforms to CE marking and with UL, CSA.
- 3) Sink/source switching of control input/output.

#### 5. Options allow use with a wide variety of applications

- Internal communications devices (RS485, Modbus RTU, DeviceNET, LonWorks etc.)
- Extension panel/Parameter writer
- DIN rail kit
- EMC noise reduction filter (Foot mount and side mount installation)
- Other options are common to all models

#### 6. Extended power range

- Wide range of powers up to 15kW for this class of inverter.
- Totally enclosed box type.

## — Contents —

I	Safety precautions .....	1
II	Introduction .....	7
1.	Read first.....	A-1
1.1	Check product purchase .....	A-1
1.2	Contents of the product.....	A-2
1.3	Names and functions .....	A-3
1.4	Notes on the application.....	A-12
2.	Connection.....	B-1
2.1	Cautions on wiring.....	B-1
2.2	Standard connections .....	B-2
2.3	Description of terminals.....	B-5
3.	Operations .....	C-1
3.1	Simplified operation of the VF-S11.....	C-2
3.2	How to operate the VF-S11.....	C-6
4.	Basic VF-S11 operations.....	D-1
4.1	Flow of status monitor mode .....	D-2
4.2	How to set parameters .....	D-3
5.	Basic parameters .....	E-1
5.1	Setting acceleration/deceleration time .....	E-1
5.2	Increasing starting torque.....	E-3
5.3	Specifying an operation mode, using parameters .....	E-6
5.4	Selection of operation mode .....	E-9
5.5	Meter setting and adjustment.....	E-11
5.6	Standard default setting .....	E-14
5.7	Forward/reverse run selection (Operation panel operation) .....	E-15
5.8	Maximum frequency.....	E-16
5.9	Upper limit and lower limit frequencies.....	E-16
5.10	Base frequency .....	E-17
5.11	Selecting control mode.....	E-18
5.12	Manual torque boost - increasing torque boost at low speeds .....	E-24
5.13	Setting the electronic thermal.....	E-24
5.14	Preset-speed operation (speeds in 15 steps).....	E-28
6.	Extended parameters.....	F-1
6.1	Input/output parameters .....	F-1

6.2	Input signal selection .....	F-4
6.3	Terminal function selection .....	F-7
6.4	Basic parameters 2.....	F-16
6.5	Frequency priority selection .....	F-17
6.6	Operation frequency .....	F-25
6.7	DC braking.....	F-26
6.8	Auto-stop in case of lower-limit frequency continuous operation .....	F-28
6.9	Jog run mode.....	F-29
6.10	Jump frequency-jumping resonant frequencies .....	F-31
6.11	Preset-speed operation frequencies .....	F-32
6.12	PWM carrier frequency .....	F-32
6.13	Trip-less intensification .....	F-34
6.14	Drooping control .....	F-45
6.15	Braking setting functions.....	F-46
6.16	Conducting PID control.....	F-47
6.17	Setting motor constants.....	F-51
6.18	Acceleration/deceleration Patterns 2 and 3 .....	F-56
6.19	Protection functions .....	F-61
6.20	Adjustment parameters.....	F-71
6.21	Operation panel parameter.....	F-73
6.22	Communication function (Common serial).....	F-80
6.23	Parameters for options .....	F-84
6.24	Permanent magnetic motors.....	F-84
7.	Applied operation.....	G-1
7.1	Setting the operation frequency.....	G-1
7.2	Setting the operation mode.....	G-5
8.	Monitoring the operation status .....	H-1
8.1	Status monitor mode.....	H-1
8.2	Display of trip information .....	H-5
9.	Measures to satisfy the standards .....	I-1
9.1	How to cope with the CE directive .....	I-1
9.2	Compliance with UL Standard and CSA Standard .....	I-5
10.	Peripheral devices .....	J-1
10.1	Selection of wiring materials and devices.....	J-1
10.2	Installation of a magnetic contactor .....	J-3
10.3	Installation of an overload relay .....	J-4
10.4	Optional external devices .....	J-5
11.	Table of parameters and data .....	K-1
11.1	User parameters.....	K-1

11.2	Basic parameters .....	K-1
11.3	Extended parameters .....	K-4
12.	Specifications .....	L-1
12.1	Models and their standard specifications .....	L-1
12.2	Outside dimensions and mass .....	L-4
13.	Before making a service call - Trip information and remedies .....	M-1
13.1	Trip causes/warnings and remedies .....	M-1
13.2	Restoring the inverter from a trip .....	M-5
13.3	If the motor does not run while no trip message is displayed .....	M-6
13.4	How to determine the causes of other problems .....	M-7
14.	Inspection and maintenance .....	N-1
14.1	Regular inspection .....	N-1
14.2	Periodical inspection .....	N-2
14.3	Making a call for servicing .....	N-4
14.4	Keeping the inverter in storage .....	N-4
15.	Warranty .....	O-1
16.	Disposal of the inverter .....	P-1

# 1. Read first

## 1.1 Check product purchase

Before using the product you have purchased, check to make sure that it is exactly what you ordered.

### Warning



Mandatory

Use an inverter that conforms to the specifications of power supply and three-phase induction motor being used. If the inverter being used does not conform to those specifications, not only will the three-phase induction motor not rotate correctly, it may also cause serious accidents through overheating and fire.

1

Rating label

Inverter main unit

Series name

Power supply

VF-S11  
1PH-200/240V-0.75kW/1HP

Motor capacity

Warning label

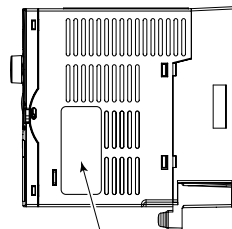

Name plate

Carton box

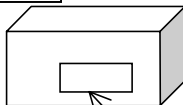

Type indication label

Instruction manual

This manual

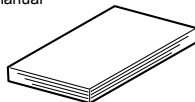

Name plate

Inverter Type  
Inverter rated output capacity  
Power supply  
Related input current  
Related output current

EMC plate

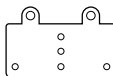

Warning label

⚠ 危険

- 付が、感電、火災のおそれがあります。
- 取扱い説明書の注意事項を厳密に守ること。
- 電源中及び電源断後10分以内は、端子カバーを開けないこと。

**⚠ DANGER**

- Read the instruction manual.
- Do not open the cover while power is applied or for 10 minutes after power has been removed.

**TOSHIBA**  
TRANSISTOR INVERTER  
VFS11-4007PL-WN(1):  
0.75kW-1.8kVA-1HP

	INPUT	OUTPUT
LV(LV)	3PH 380/500	3PH 380/500
F(Hz)	50/60	0.5/500
VA(A)	3.9/2.7	2.3

S-Clst 5000A + FUSE CCU 6Amax  
Cu AWG14.75°C  
10.7lb-in/1.2 Nm

Serial No. 1234 57000000 0000  
Lot No. 101M160

Made in Japan  
Motor Protective Device Class: 10

NI971  
Group 1 Class A

UL LISTED 175W  
RECOGNIZED

**TOSHIBA CORPORATION**  
TSU

## 1.2 Contents of the product

Explanation of the name plate label.

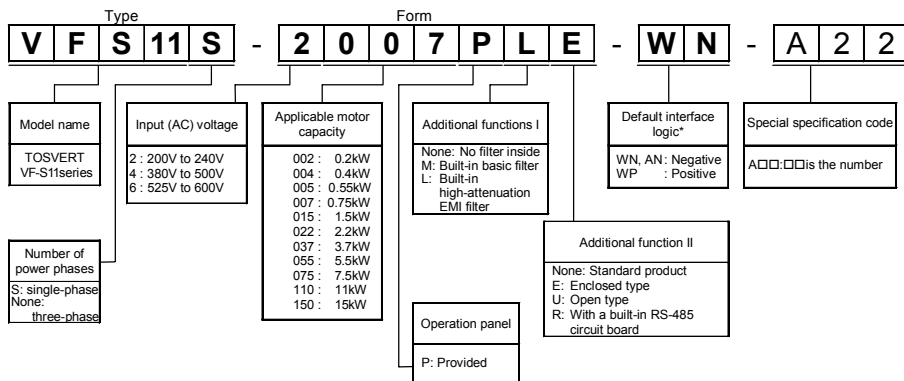

\* This code represents the factory default logic setting. You can switch from one input/output logic to the other using slide switch SW1. (See 2.3.2)

Warning: Always shut power off first then check the ratings label of inverter held in a cabinet.

## 1.3 Names and functions

### 1.3.1 Outside view

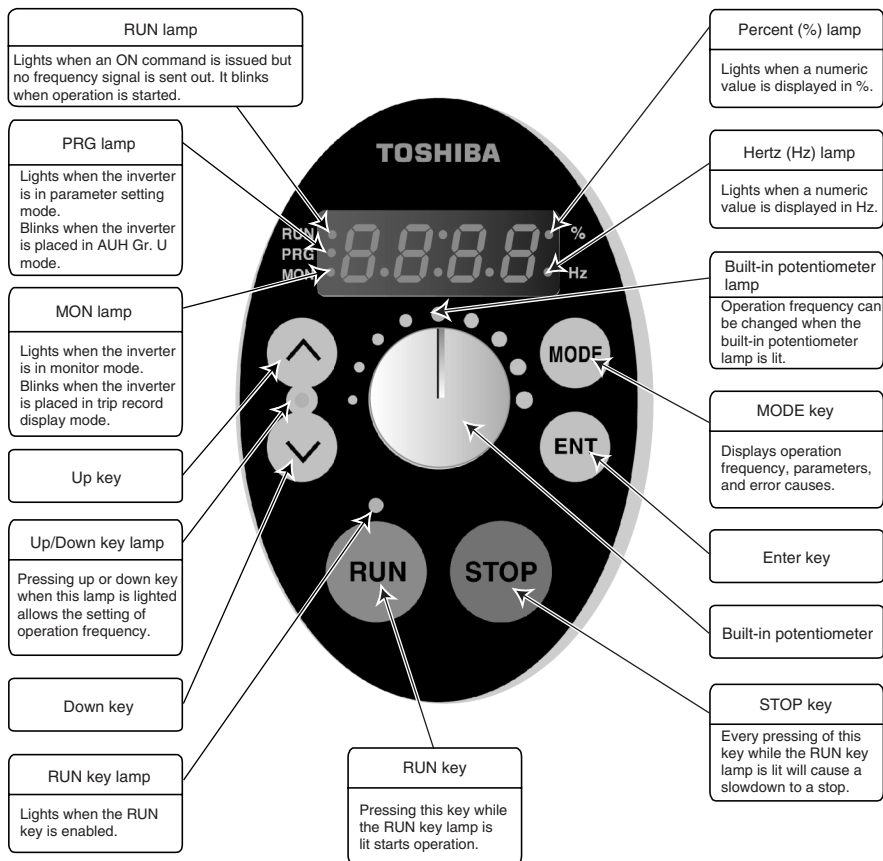

[Front panel 1]



Example of the label

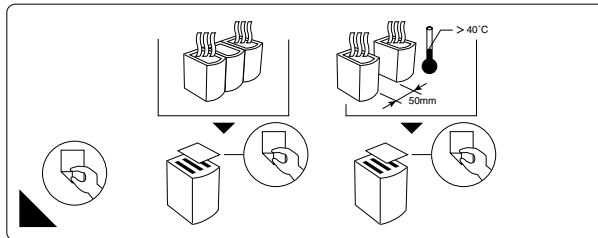

1

### 1.3.2 Power circuit and control circuit terminal boards

In case of the lug connector, cover the lug connector with insulated tube, or use the insulated lug connector.

Note 1: EMC plate is supplied as standard.

#### 1) Power circuit terminal board

In case of the lug connector, cover the lug connector with insulated tube, or use the insulated lug connector.

Screw size	tightening torque	
M3.5 screw	0.9Nm	7.1lb • in
M4 screw	1.3Nm	10.7lb • in
M5 screw	2.5Nm	22.3lb • in
M6 screw	4.5Nm	40.1lb • in

VFS11-2002 ~ 2007PM

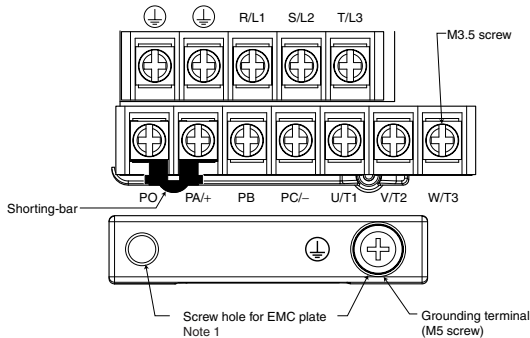

VFS11-2015 ~ 2037PM

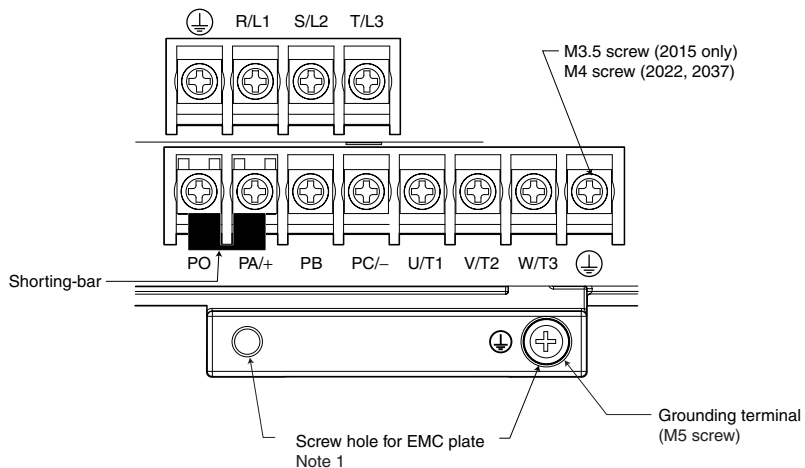

VFS11S-2002 ~ 2007PL

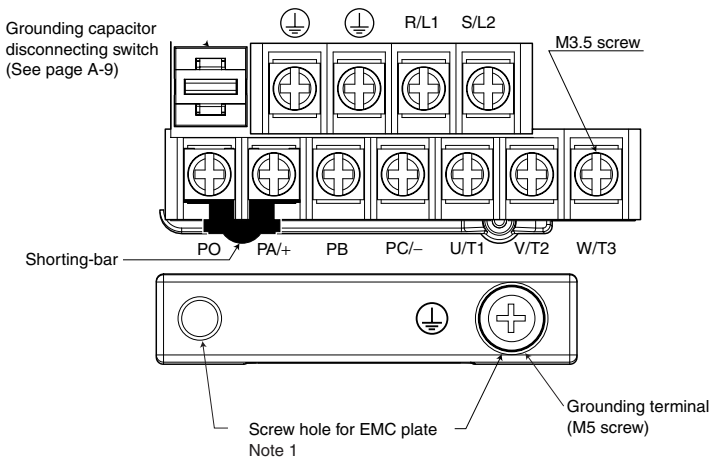

VFS11S-2015, 2022PL

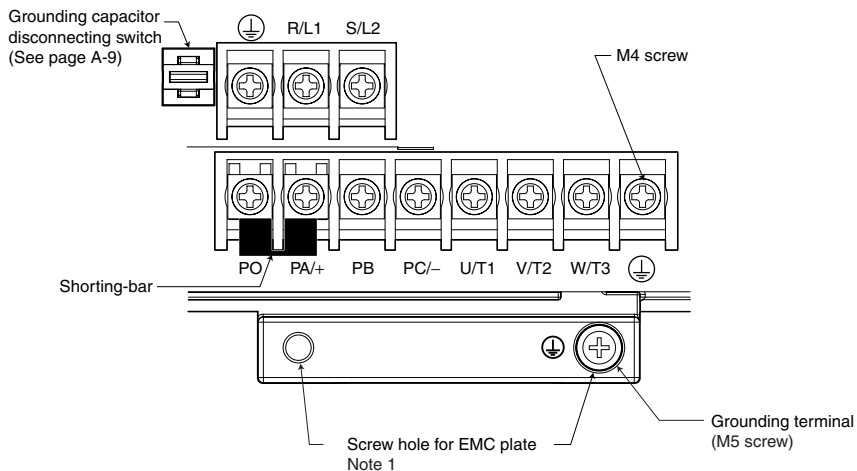

VFS11-4004 ~ 4037PL, 6007 ~ 6037P

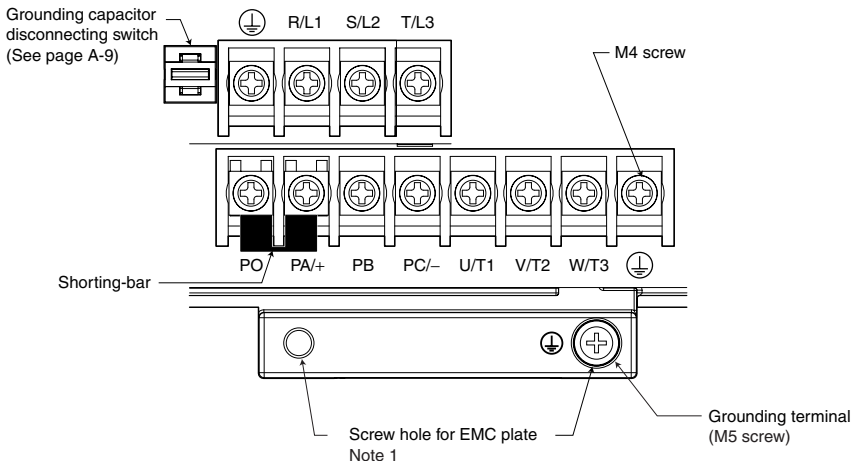

1

VFS11-2055, 2075PM  
-4055, 4075PL, 6055, 6075P

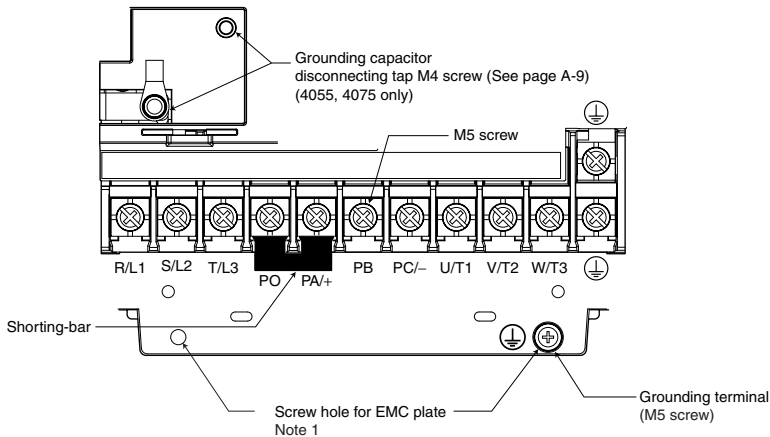

VFS11-2110, 2150PM  
-4110, 4150PL, 6110, 6150P

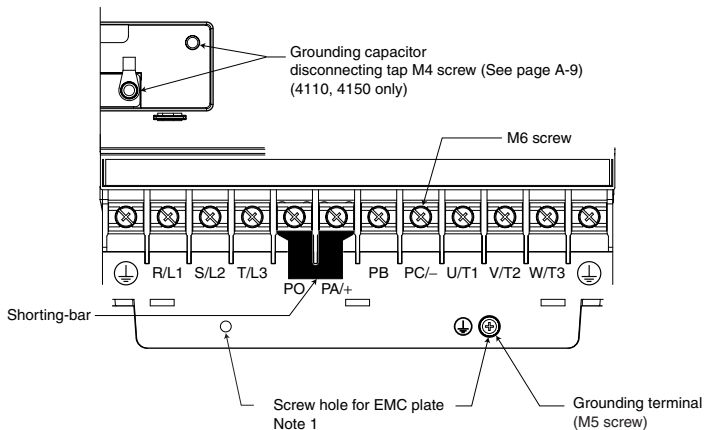

## 2) Grounding capacitor disconnecting switch and taps

 **Warning**

Mandatory

The grounding capacitor disconnecting tap is provided with a protection cover. To avoid shock hazards, always attach the cover after connecting or disconnecting the capacitor to or from the tap.

Every single-phase 240V/three-phase 500V model has a built-in high-attenuation noise filter, which is grounded through a capacitor.

If you want to disconnect the capacitor from the grounding line to reduce the amount of leakage current, you can do so easily using the switch or tap. Keep in mind, however, that disconnecting the capacitor from the grounding line causes the inverter to become non-compliant with the EMC directive. Also note that the inverter must always be turned off before the capacitor is disconnected or reconnected.

Note) In case of three phase 500V-4.0kW model, if you disconnect the capacitor from ground, set the parameter of carrier frequency  $F_{\text{CG}}$  to 4kHz or less with motor cable length 30m or less.

## 4.0kW or less : Switch



← To connect the capacitor to ground, push this switch.  
(Factory default position)



← To disconnect the capacitor from ground, pull up this switch.

## 5.5kW or more : Tap

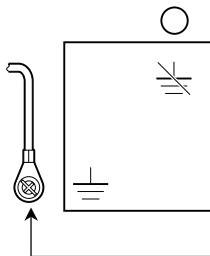

← To disconnect the capacitor from ground, connect the lug terminal to this tap.

← To connect the capacitor to ground, connect the lug terminal to this tap. (Factory default setting)

### 3) Control circuit terminal board

The control circuit terminal board is common to all equipment.

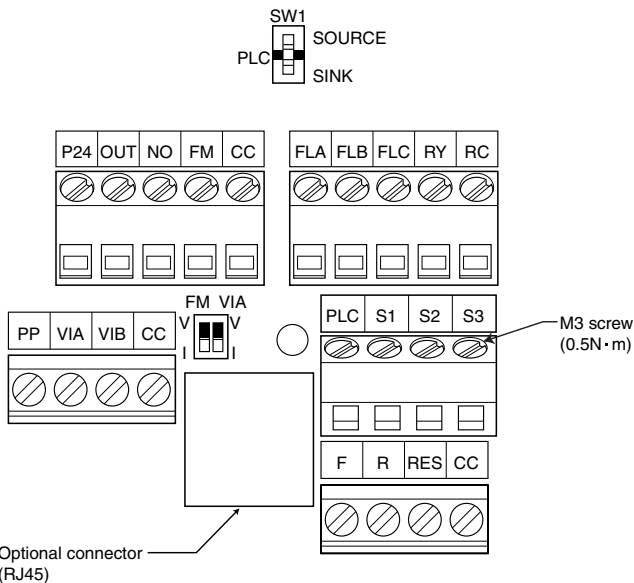

#### Wire size

Solid wire: 0.3 ~ 1.5 (mm<sup>2</sup>)

Stranded wire: 0.3 ~ 1.5 (mm<sup>2</sup>)  
(AWG 22 ~ 16)

Sheath strip length: 6 (mm)

Screwdriver: Small-sized flat-blade screwdriver

(Blade thickness: 0.4 mm or less, blade width: 2.2 mm or less)

#### Factory default settings of side switches

SW1: SINK (Negative) side (WN, AN type)

SOURCE (Positive) side (WP type)

FM: V side

VIA: V side

See 2.3.2 for details on all terminal functions.

### 1.3.3 How to open the front (terminal board) cover

To wire the terminal board, remove the front lower cover in line with the steps given below.

(1)

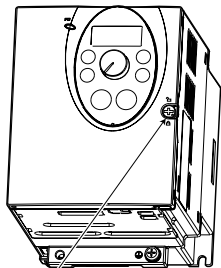

Turn the locking screw on the right side of the front panel 90° counterclockwise to align the dot on the screw with the unlock position mark (upper side). To avoid damage to the screw, do not apply excessive force to turn the screw more than 90 degrees.

(2)

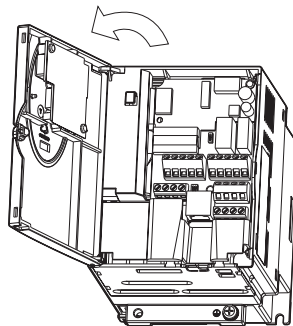

Pull the front panel toward you and swing it open to the left.

(3)

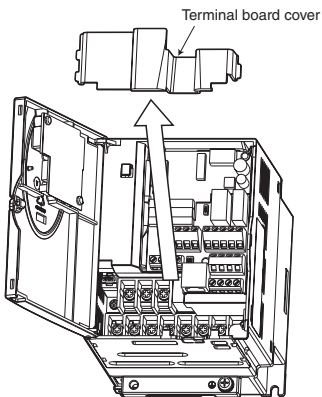

Remove the terminal board cover by pulling it up toward you.

(4)

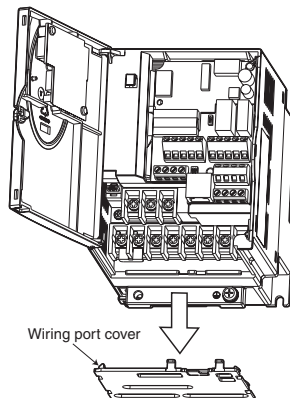

Remove the wiring port cover by pulling it down, pass cables through the wiring port, and connect the cables to the terminal board.

## 1.4 Notes on the application

### 1.4.1 Motors

When the VF-S11 and the motor are used in conjunction, pay attention to the following items.

#### Warning



Mandatory

Use an inverter that conforms to the specifications of power supply and three-phase induction motor being used. If the inverter being used does not conform to those specifications, not only will the three-phase induction motor not rotate correctly, but it may cause serious accidents through overheating and fire.

#### Comparisons with commercial power operation.

The VF-S11 Inverter employs the sinusoidal PWM system. However, the output voltage and output current are not perfect sine waves, they have a distorted wave that is close to sinusoidal waveform. This is why compared to operation with a commercial power there will be a slight increase in motor temperature, noise and vibration.

#### Operation in the low-speed area

When running continuously at low speed in conjunction with a general purpose motor, there may be a decline in that motor's cooling effect. If this happens, operate with the output decreased from rated load.

To carry out low-speed operation continuously at the rated torque, we recommend to use a inverter rated motor or a forced cooled motor designed for use with an inverter. When operating in conjunction with a inverter rated motor, you must change the inverter's motor overload protection level to VF motor use ( $\overline{I}_L$ ).

#### Adjusting the overload protection level

The VF-S11 Inverter protects against overloads with its overload detection circuits (electronic thermal). The electronic thermal's reference current is set to the inverter's rated current, so it must be adjusted in line with the rated current of the general purpose motor being used in combination.

#### High speed operation at and above 60Hz

Operating at frequencies greater than 60Hz will increase noise and vibration. There is also a possibility this will exceed the motor's mechanical strength limits and the bearing limits so you should inquire to the motor's manufacturer about such operation.

#### Method of lubricating load mechanisms

Operating an oil-lubricated reduction gear and gear motor in the low-speed areas will worsen the lubricating effect. Check with the manufacturer of the reduction gear to find out about operable gearing area.

### Low loads and low inertia loads

The motor may demonstrate instability such as abnormal vibrations or overcurrent trips at light loads of 50 % or under of the load percentage, or when the load's inertia moment is extremely small. If that happens reduce the carrier frequency.

### Occurrence of instability

Unstable phenomena may occur with the load and motor combinations shown below.

- Combined with a motor that exceeds applicable motor ratings recommended for the inverter
- Combined with special motors
- For 600V class or 500V class with long cable

To deal with the above lower the settings of inverter carrier frequency.

- Combined with couplings between load devices and motors with high backlash

When using the inverter in the above combination, use the S-pattern acceleration/deceleration function, or when vector control is selected, adjust the speed control response/stability factor or switch to V/f control mode.

- Combined with loads that have sharp fluctuations in rotation such as piston movements

In this case, adjust the response time (inertial moment setting) during vector control or switch to V/f control.

### Braking a motor when cutting off power supply

A motor with its power cut off goes into free-run, and does not stop immediately. To stop the motor quickly as soon as the power is cut off install an auxiliary brake. There are different kinds of brake devices, both electrical and mechanical. Select the brake that is best for the system.

### Load that produces regenerative torque

When combined with a load that produces regenerative torque, the overvoltage or overcurrent protection function may be activated to trip the inverter. For this kind of situation, you must install a dynamic braking resistor that complies with the load conditions, or increase deceleration time.

## Braking motor

When using a braking motor, if the braking circuit is directly connected to the inverter's output terminals, the brake cannot be released because of the lowered starting voltage. Therefore, when using a braking motor, connect the braking circuit to the inverter's power supply side, as shown in the figure below. Usually, braking motors produce larger noise in low speed ranges.

Note: In the case of the circuit shown on the below, assign the function of detecting low-speed signals to the RY and RC terminals. Make sure the parameter  $F \ 1 \ 3 \ 0$  is set to 4 (factory default setting).

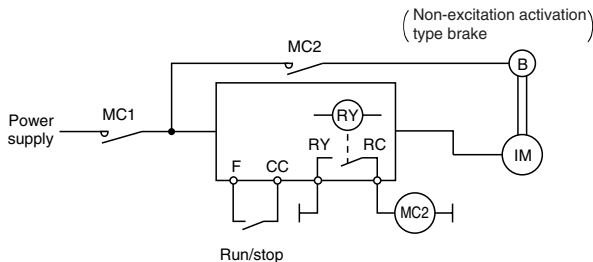

## Measures to protect motors against surge voltages

In a system in which a 500V-class inverter is used to control the operation of a motor, very high surge voltages may be produced. When applied to the motor coils repeatedly for a long time, may cause deterioration of their insulation, depending on the cable length, cable routing and types of cables used. Here are some examples of measures against surge voltages.

- (1) Lower the inverter's carrier frequency.
- (2) Set the parameter  $F \ 3 \ 1 \ 5$  (Carrier frequency control mode selection) to 2 or 3.
- (3) Use a motor with high insulation strength.
- (4) Insert an AC reactor or a surge voltage suppression filter between the inverter and the motor.

## 1.4.2 Inverters

### Protecting inverters from overcurrent

The inverter has an overcurrent protection function. The programmed current level is set to the inverter's maximum applicable motor. If the motor used has a small capacity, the overcurrent level and the electronic thermal protection must be readjusted. If adjustment is necessary, see 5-13, and make adjustments as directed.

### Inverter capacity

Do not use a small-capacity (kVA) inverter to control the operation of a large-capacity motor (two-class or more larger motor), no matter how light the load is. Current ripple will raise the output peak current making it easier to set off the overcurrent trip.

## Power factor correction capacitor

Power factor correction capacitors cannot be installed on the output side of the inverter. When a motor is run that has a power factor correction capacitor attached to it, remove the capacitors. This can cause inverter malfunction trips and capacitor destruction.

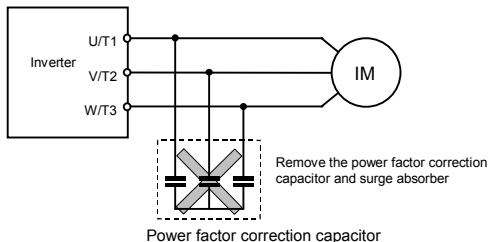

## Operating at other than rated voltage

Connections to voltages other than the rated voltage described in the rating label cannot be made. If a connection must be made to a power supply other than one with rated voltage, use a transformer to raise or lower the voltage to the rated voltage.

Circuit breaking when two or more inverters are used on the same power line.

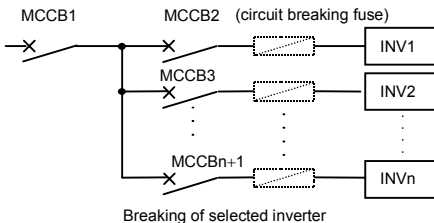

There is no fuse in the inverter's main circuit. Thus, as the diagram above shows, when more than one inverter is used on the same power line, you must select interrupting characteristics so that only the MCCB2 will trip and the MCCB1 will not trip when a short occurs in the inverter (INV1). When you cannot select the proper characteristics install a circuit interrupting fuse between the MCCB2 and the INV1.

## If power supply distortion is not negligible

If the power supply distortion is not negligible because the inverter shares a power distribution line with other systems causing distorted waves, such as systems with thyristors or large-capacity inverters, install an input reactor to improve the input power factor, to reduce higher harmonics, or to suppress external surges.

## ■ Disposal

If an inverter is no longer usable, dispose of it as industrial waste.

### 1.4.3 What to do about the leak current

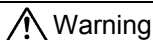

**Warning**

Current may leak through the inverter's input/output wires because of insufficient electrostatic capacity on the motor with bad effects on peripheral equipment.

The leakage current's value is affected by the carrier frequency and the length of the input/output wires. Test and adopt the following remedies against leak current.

#### (1) Effects of leak current across ground

Leakage current may flow not just through the inverter system but also through ground wires to other systems. Leakage current will cause earth leakage breakers, leakage current relays, ground relays, fire alarms and sensors to operate improperly, and it will cause superimposed noise on the CRT screen or display of incorrect current detection with the CT.

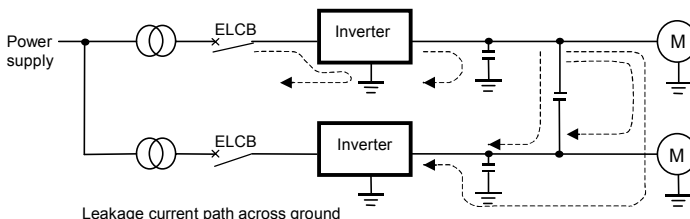

#### Remedies:

1. If there is no radio-frequency interference or similar problem, detach the built-in noise filter capacitor, using the grounding capacitor disconnecting switch or tap. (See 1.3.2-2)
2. Reduce PWM carrier frequency.  
The setting of PWM carrier frequency is done with the parameter *F300*.  
Although the electromagnetic noise level is reduced, the motor acoustic noise is increased.
3. Use high frequency remedial products for earth leakage breakers.

## (2) Affects of leakage current across lines

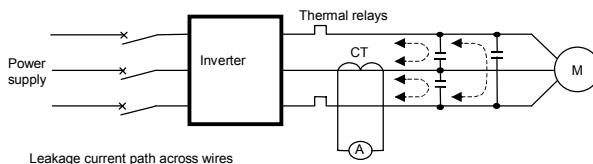

## (1) Thermal relays

The high frequency component of current leaking into electrostatic capacity between inverter output wires will increase the effective current values and make externally connected thermal relays operate improperly. If the wires are more than 50 meters long, it will be easy for the external thermal relay to operate improperly with models having motors of low rated current (several A (ampere) or less), especially the 500V and 600V class low capacity (3.7kW or less) models, because the leak current will increase in proportion to the motor rating.

## Remedies:

1. Use the electronic thermal built into the inverter. (See 5.13)

The setting of the electronic thermal is done using parameter  $\sigma L n, t H r$ .

2. Reduce the inverter's PWM carrier frequency. However, that will increase the motor's magnetic noise.

The setting of PWM carrier frequency is done with the parameter  $F 300$ . (See 6.12)

3. This can be improved by installing  $0.1\mu\text{--}0.5\mu\text{F}$  - 1000V film capacitor to the input/output terminals of each phase in the thermal relay.

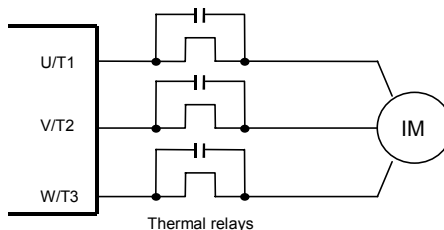

## (2) CT and ammeter

If a CT and ammeter are connected externally to detect inverter output current, the leak current's high frequency component may destroy the ammeter. If the wires are more than 50 meters long, it will be easy for the high frequency component to pass through the externally connected CT and be superimposed on and burn the ammeter with models having motors of low rated current (several A(ampere) or less), especially the 500V and 600V class low capacity (3.7kW or less) models, because the leak current will increase in proportion to the motor's rated current.

## Remedies:

1. Use a meter output terminal in the inverter control circuit.

The load current can be output on the meter output terminal (FM). If the meter is connected, use an ammeter of 1mA<sub>dc</sub> full scale or a voltmeter of 7.5V-1mA full scale.

0-20mA<sub>dc</sub> (4-20mA<sub>dc</sub>) can be also output. (See 5.5)



2. Use the monitor functions built into the inverter.



Use the monitor functions on the panel built into the inverter to check current values. (See 8.1.1)

## 1.4.4 Installation

### ■ Installation environment

The VF-S11 Inverter is an electronic control instrument. Take full consideration to installing it in the proper operating environment.

 <b>Danger</b>	
 Prohibited	<ul style="list-style-type: none"> <li>Do not place any inflammable substances near the VF-S11 Inverter. If an accident occurs in which flame is emitted, this could lead to fire.</li> </ul>
 Mandatory	<ul style="list-style-type: none"> <li>Operate under the environmental conditions prescribed in the instruction manual. Operations under any other conditions may result in malfunction.</li> </ul>

 <b>Warning</b>	
 Prohibited	<ul style="list-style-type: none"> <li>Do not install the VF-S11 Inverter in any location subject to large amounts of vibration. This could cause the unit to fall, resulting in bodily injury.</li> </ul>
 Mandatory	<ul style="list-style-type: none"> <li>Check to make sure that the input power voltage is +10%, -15% of the rated power voltage written on the rating label (<math>\pm 10\%</math> when the load is 100% in continuous operation) If the input power voltage is not +10%, -15% of the rated power voltage (<math>\pm 10\%</math> when the load is 100% in continuous operation) this may result in fire.</li> </ul>

 **Warning**



- Avoid operation in any location where there is direct spraying of the following solvents or other chemicals. The plastic parts may be damaged to a certain degree depending on their shape, and there is a possibility of the plastic covers coming off. If the chemical or solvent is anything other than those shown below, please contact us in advance.

((Table 1) Examples of applicable chemicals and solvents

Acetic acid (density of 10% or less)
Hydrochloric acid (density of 10% or less)
Sulfuric acid (density of 10% or less)
Sodium chloride
Hexane
Triethylene glycol

(Table 2) Examples of unapplicable chemicals and solvents

Acetone
Benzene
Chloroform
Ethylene chloride
Ethyl acetate
Glycerin
Tetrachloroethylene
Trichloroethylene
Xylene

Note: The plastic cover has resistance to deformation by the above applicable solvents. They are not examples for resistance to fire or explosion.



- Do not install in any location of high temperature, high humidity, moisture condensation and freezing and avoid locations where there is exposure to water and/or where there may be large amounts of dust, metallic fragments and oil mist.
  - Do not install in any location where corrosive gases or grinding fluids are present.
- Operate in areas where ambient temperature ranges from -10°C to 60°C. Operation over 40°C is allowed when the top label is peeled off. When installing the inverter where the ambient temperature will rise above 50°C, remove the label (seal) from the top and operate it at a current lower than the rated one.

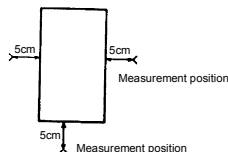

Note: The inverter is a heat-emitting body. Make sure proper space and ventilation is provided when installing in the cabinet. When installing inside a cabinet, we recommend the top seal peeled off although 40°C or less.

- Do not install in any location that is subject to large amounts of vibration.





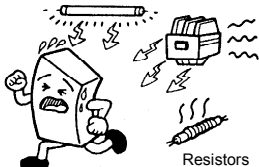

Note: If the VF-S11 Inverter is installed in a location that is subject to vibration, anti-vibration measures are required. Please consult with Toshiba about these measures.

- If the VF-S11 Inverter is installed near any of the equipment listed below, provide measures to insure against errors in operation.



- Solenoids: Attach surge suppressor on coil.
- Brakes: Attach surge suppressor on coil.
- Magnetic contactors: Attach surge suppressor on coil.
- Fluorescent lights: Attach surge suppressor on coil.
- Resistors: Place far away from VF-S11 Inverter.

## ■ How to install

 <b>Danger</b>	
 Prohibited	<ul style="list-style-type: none"> <li>Do not install or operate the inverter if it is damaged or any component is missing. This can result in electric shock or fire. Please consult your local sales agency for repairs. Call your local sales agency for repairs.</li> </ul>
 Mandatory	<ul style="list-style-type: none"> <li>Mount the inverter on a metal plate. The rear panel gets very hot. Do not install in an inflammable object, this can result in fire.</li> <li>Do not operate with the front panel cover removed. This can result in electric shock.</li> <li>An emergency stop device must be installed that fits with system specifications (e.g. shut off input power then engage mechanical brake). Operation cannot be stopped immediately by the inverter alone, thus risking an accident or injury.</li> <li>All options used must be those specified by Toshiba. The use of any other option may result in an accident.</li> </ul>
 <b>Warning</b>	
 Mandatory	<ul style="list-style-type: none"> <li>The main unit must be installed on a base that can bear the unit's weight. If the unit is installed on a base that cannot withstand that weight, the unit may fall resulting in injury.</li> <li>If braking is necessary (to hold motor shaft), install a mechanical brake. The brake on the inverter will not function as a mechanical hold, and if used for that purpose, injury may result.</li> </ul>

Install the inverter in a well-ventilated indoor place and mount it on a flat metal plate in portrait orientation. If you are installing more than one inverter, the separation between inverters should be at least 5 centimeters, and they should be arranged in horizontal rows. If the inverters are horizontally arranged with no space between them (side-by-side installation), peel off the ventilation seals on top of the inverter. It is necessary to decrease the current if the inverter is operated at over 50°C.

●Standard installation

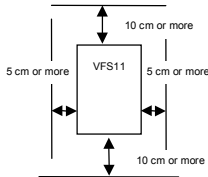

●Side-by-side installation

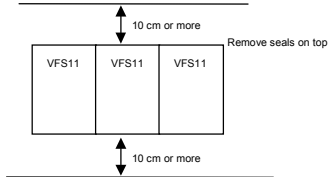

The space shown in the diagram is the minimum allowable space. Because air cooled equipment has cooling fans built in on the top or bottom surfaces, make the space on top and bottom as large as possible to allow for air passage.

Note: Do not install in any location where there is high humidity or high temperatures and where there are large amounts of dust, metallic fragments and oil mist.

## ■ Calorific values of the inverter and the required ventilation

About 5% of the rated power of the inverter will be lost as a result of conversion from AC to DC or from DC to AC. In order to suppress the rise in temperature inside the cabinet when this loss becomes heat loss, the interior of the cabinet must be ventilated and cooled.

The amount of forcible air-cooling ventilation required and the necessary heat discharge surface quantity when operating in a sealed cabinet according to motor capacity are as follows.

Notes

- 1) The heat loss for the optional external devices (input reactor, DC reactor, radio noise reduction filters, etc.) is not included in the calorific values in the table
- 2) Case of 100% Load Continuation operation.

Voltage class	Operating motor capacity (kW)	Inverter type	Calorific Values		Amount of forcible air cooling ventilation required (m <sup>3</sup> /min)	Heat discharge surface area required for sealed storage cabinet(m <sup>2</sup> )		
			Carrier frequency 4kHz	Carrier frequency 12kHz				
Single-phase 240V class	0.2	VFS11S	2002PL	21	26	0.15	0.52	
	0.4		2004PL	36	44	0.25	0.88	
	0.75		2007PL	52	59	0.34	1.18	
	1.5		2015PL	87	99	0.56	1.98	
	2.2		2022PL	116	125	0.71	2.50	
Three -Phase 240V class	0.2	VFS11-	2002PM	21	26	0.15	0.52	
	0.4		2004PM	36	44	0.25	0.88	
	0.55		2005PM	40	46	0.26	0.92	
	0.75		2007PM	51	58	0.33	1.16	
	1.5		2015PM	88	101	0.58	2.02	
	2.2		2022PM	115	125	0.71	2.50	
	4.0		2037PM	171	188	1.07	3.76	
	5.5		2055PM	266	281	1.60	5.62	
	7.5		2075PM	349	392	2.23	7.84	
	11		2110PM	489	549	3.13	10.98	
	15		2150PM	634	704	4.01	14.08	
Three-Phase 500V class	0.4	VFS11-	4004PL	43	60	0.34	1.20	
	0.75		4007PL	51	68	0.39	1.36	
	1.5		4015PL	71	95	0.54	1.90	
	2.2		4022PL	88	118	0.67	2.36	
	4.0		4037PL	138	161	0.92	3.22	
	5.5		4055PL	205	230	1.31	4.60	
	7.5		4075PL	247	324	1.85	6.48	
Three-Phase 600V class	11	VFS11-	4110PL	414	551	3.14	11.02	
	15		4150PL	501	659	3.76	13.18	
	0.75		VFS11-	6007P	48	64	0.36	1.28
	1.5			6015P	61	83	0.47	1.66
	2.2			6022P	76	104	0.59	2.08
	4.0			6037P	97	119	0.68	2.38
	5.5			6055P	132	155	0.88	3.10
7.5	6075P	171		216	1.40	4.32		
11	6110P	302		422	2.41	8.44		
15	6150P	383	527	3.00	10.54			

## ■ Panel designing taking into consideration the effects of noise

The inverter generates high frequency noise. When designing the control panel setup, consideration must be given to that noise. Examples of measures are given below.

- Wire so that the main circuit wires and the control circuit wires are separated. Do not place them in the same conduit, do not run them parallel, and do not bundle them.
- Provide shielding and twisted wire for control circuit wiring.
- Separate the input (power) and output (motor) wires of the main circuit. Do not place them in the same conduit, do not run them parallel, and do not bundle them.
- Ground the inverter ground terminals (⏏).
- Install surge suppressor on any magnetic contactor and relay coils used around the inverter.
- Install noise filters if necessary.

- Install EMC plate and use shielded wires.

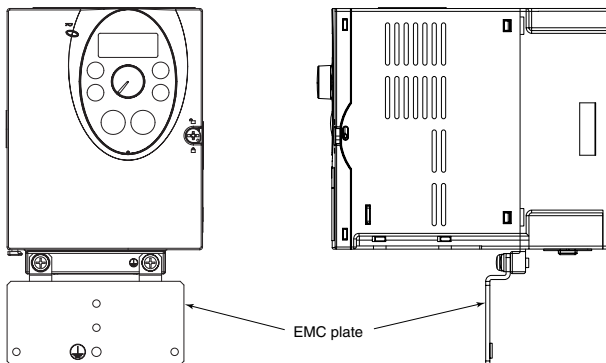

## ■ Installing more than one unit in a cabinet

If you are installing two or more inverters in one cabinet, pay attention to the following.



- Inverters may be installed side by side with each other with no space left between them.
- When installing inverters side by side, detach the caution label on the top surface of each inverter and use them where the ambient temperature will not rise above 40°C.

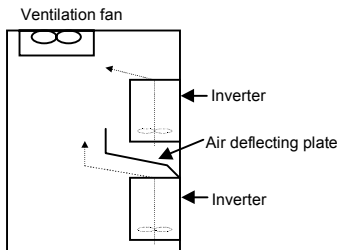

When using inverters where the ambient temperature will rise above 40°C, leave a space of 5 cm or more between them and remove the caution label from the top of each inverter, or operate each inverter at a current lower than the rated one.

- Ensure a space of at least 20 centimeters on the top and bottom of the inverters.
- Install an air deflecting plate so that the heat rising up from the inverter on the bottom does not affect the inverter on the top.







## 2. Connection



 <b>Danger</b>	
 Disassembly prohibited	<ul style="list-style-type: none"> <li>• Never disassemble, modify or repair. This can result in electric shock, fire and injury. For repairs, call your sales agency.</li> </ul>
 Prohibited	<ul style="list-style-type: none"> <li>• Don't stick your fingers into openings such as cable wiring hole and cooling fan covers. This can result in electric shock or other injury.</li> <li>• Don't place or insert any kind of object into the inverter (electrical wire cuttings, rods, wires). This can result in electric shock or fire.</li> <li>• Do not allow water or any other fluid to come in contact with the inverter. That may result in electric shock or fire.</li> </ul>

 <b>Warning</b>	
 Prohibited	<ul style="list-style-type: none"> <li>• When transporting or carrying, do not hold by the front panel covers. The covers may come off and the unit will drop out resulting in injury.</li> </ul>

### 2.1 Cautions on wiring

 <b>Danger</b>	
 Prohibited	<ul style="list-style-type: none"> <li>• Never remove the front cover when power is on or open door if enclosed in a cabinet. The unit contains many high voltage parts and contact with them will result in electric shock.</li> </ul>
 Mandatory	<ul style="list-style-type: none"> <li>• Turn power on only after attaching the front cover or closing door if enclosed in a cabinet. If power is turned on without the front cover attached or closing door if enclosed in a cabinet. This can result in electric shock or other injury.</li> <li>• Electrical construction work must be done by a qualified expert. Connection of input power by someone who does not have that expert knowledge may result in fire or electric shock.</li> <li>• Connect output terminals (motor side) correctly. If the phase sequence is incorrect, the motor will operate in reverse and that may result in injury.</li> <li>• Wiring must be done after installation. If wiring is done prior to installation that may result in injury or electric shock.</li> <li>• The following steps must be performed before wiring.             <ol style="list-style-type: none"> <li>(1) Shut off all input power.</li> <li>(2) Wait at least ten minutes and check to make sure that the charge lamp is no longer lit.</li> <li>(3) Use a tester that can measure DC voltage (800VDC or more), and check to make sure that the voltage to the DC main circuits (across PA-PC) is 45V or less.</li> </ol>             If these steps are not properly performed, the wiring will cause electric shock.           </li> <li>• Tighten the screws on the terminal board to specified torque. If the screws are not tightened to the specified torque, it may lead to fire.</li> </ul>

 <b>Danger</b>	
 Be Grounded	<ul style="list-style-type: none"> <li>Ground must be connected securely. If the ground is not securely connected, it could lead to electric shock or fire when a malfunction or current leak occurs.</li> </ul>

 <b>Warning</b>	
 Prohibited	<ul style="list-style-type: none"> <li>Do not attach devices with built-in capacitors (such as noise filters or surge absorber) to the output (motor side) terminal. This could cause a fire.</li> </ul>

### ■ Preventing radio noise

To prevent electrical interference such as radio noise, separately bundle wires to the main circuit's power terminals (R/L1, S/L2, T/L3) and wires to the motor terminals (U/T1, V/T2, W/T3).



### ■ Control and main power supply

The control power supply and the main circuit power supply for the VFS11 are the same. (See 6.19.3)  
If a malfunction or trip causes the main circuit to be shut off, control power will also be shut off. When checking the cause of the malfunction or the trip, use the trip holding retention selection parameter.

### ■ Wiring

- Because the space between the main circuit terminals is small use sleeved pressure terminals for the connections. Connect the terminals so that adjacent terminals do not touch each other.
- For ground terminal  use wires of the size that is equivalent to or larger than those given in table 10.1 and always ground the inverter (240V voltage class: D type ground, 500V class: C type ground).  
Use as large and short a ground wire as possible and wire it as close as possible to the inverter.
- For the sizes of electric wires used in the main circuit, see the table in 10.1.
- The length of the main circuit wire in 10-1 should be no longer than 30 meters. If the wire is longer than 30 meters, the wire size (diameter) must be increased.

## 2.2 Standard connections

 <b>Danger</b>	
 Prohibited	<ul style="list-style-type: none"> <li>Do not connect input power to the output (motor side) terminals (U/T1, V/T2, W/T3). Connecting input power to the output could destroy the inverter or cause a fire.</li> <li>Do not insert a resistor between DC terminals (between PA/+ and PC/-, or between PO and PC/-). It could cause a fire. See 6.13.4 for the connection of a resistor.</li> <li>First shut off input power and wait at least 10 minutes before touching wires on equipment (MCCB) that is connected to inverter power side. Touching the wires before that time could result in electric shock.</li> </ul>

## 2.2.1 Standard connection diagram 1

This diagram shows a standard wiring of the main circuit.

Standard connection diagram - SINK (Negative) (common:CC)

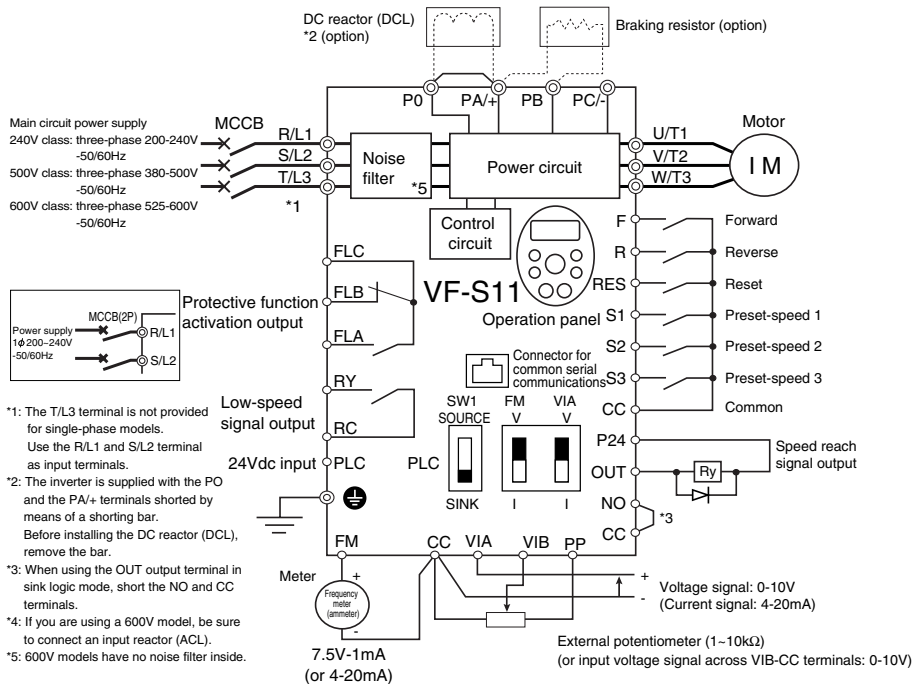

## 2.2.2 Standard connection diagram 2

Standard connection diagram - SOURCE (Positive) (common:P24)

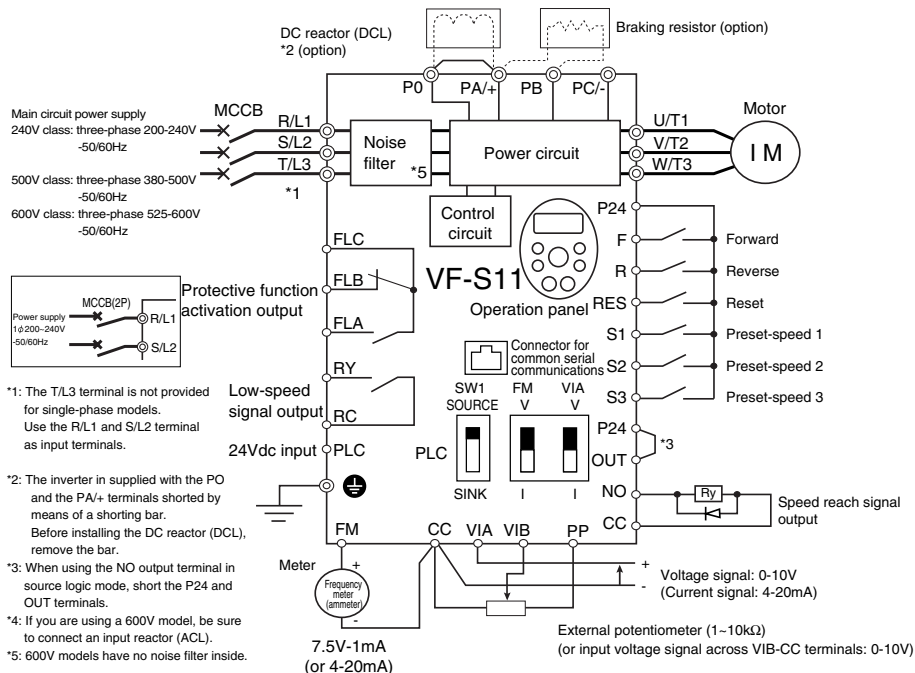

## 2.3 Description of terminals

### 2.3.1 Power circuit terminals

This diagram shows an example of wiring of the main circuit. Use options if necessary.

#### ■ Power supply and motor connections

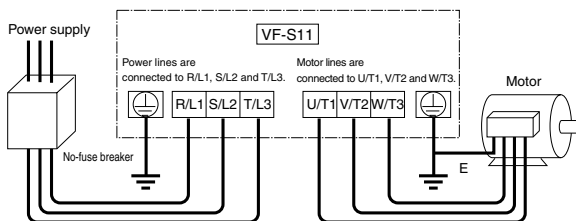

#### ■ Connections with peripheral equipment

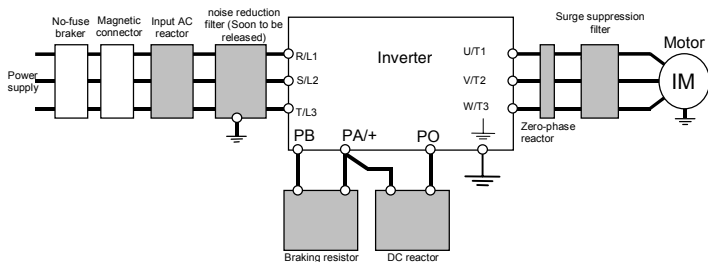

Note 1: The T/L3 terminal is not provided for any single-phase 240V model. So if you are using a single-phase 240V model, use the R/L1 and S/L2 terminals to connect power cables.

Note 2: If you are using a 600V model, be sure to connect an input reactor (ACL).



Terminal symbol	Input/output	Function	Electrical specifications	Inverter internal circuits
CC	Common to Input/output	Control circuit's equipotential terminal (3 terminals)		
PP	Output	Analog power supply output	10Vdc (permissible load current: 10mA)	
VIA	Input	Multifunction programmable analog input. Factory default setting: 0~10Vdc and 0~60Hz (0~50Hz) frequency input. The function can be changed to 4~20mA (0~20mA) current input by flipping the dip switch to the I position.  By changing parameter setting, this terminal can also be used as a multifunction programmable contact input terminal. When using the sink logic, be sure to insert a resistor between P24-VIA (4.7 kΩ-1/2 W). Also move the VIA dip switch to the V position.	10Vdc (internal impedance: 30kΩ)  4-20mA (internal impedance: 250Ω)	
VIB	Input	Multifunction programmable analog input. Standard default setting: 0~10Vdc input and 0~60Hz (0~50Hz) frequency  By changing parameter setting, this terminal can also be used as a multifunction programmable contact input terminal. When using the sink logic, be sure to insert a resistor between P24 and VIB. (4.7 kΩ-1/2 W)	10Vdc (internal impedance: 30kΩ)	
FM	Output	Multifunction programmable analog output. Standard default setting: output frequency.  The function can be changed to 0-20mA (4-20mA) current output by flipping the FM slide switch to the I position.	1mA DC full-scale ammeter or 7.5Vdc (10Vdc) 1mA full-scale voltmeter  0-20mA (4-20mA) DC ammeter  Permissible load resistance: 750Ω or less	

Terminal symbol	Input/output	Function	Electrical specifications	Inverter internal circuits
P24	Output	24Vdc power output	24Vdc-100mA	
OUT NO	Output	<p>Multifunction programmable open collector output. Standard default settings detect and output speed reach signal output frequencies.</p> <p>Multifunction output terminals to which two different functions can be assigned. The NO terminal is an isoelectric output terminal. It is insulated from the CC terminal.</p> <p>By changing parameter settings, these terminals can also be used as multifunction programmable pulse train output terminals.</p>	<p>Open collector output 24Vdc-50mA</p> <p>To output pulse trains, a current of 10mA or more needs to be passed.</p> <p>Pulse frequency range: 38~1600Hz</p>	
FLA FLB FLC	Output	<p>Multifunction programmable relay contact output.</p> <p>Detects the operation of the inverter's protection function.</p> <p>Contact across FLA-FLC is closed and FLB-FLC is opened during protection function operation.</p>	<p>250Vac-1A (<math>\cos\phi=1</math>) : at resistance load 30Vdc-0.5A 250Vac-0.5A (<math>\cos\phi=0.4</math>)</p>	
RY RC	Output	<p>Multifunction programmable relay contact output.</p> <p>Standard default settings detect and output low-speed signal output frequencies.</p> <p>Multifunction output terminals to which two different functions can be assigned.</p>	<p>250Vac-1A (<math>\cos\phi=1</math>) : at resistance load 30Vdc-0.5A 250Vac-0.5A (<math>\cos\phi=0.4</math>)</p>	

\* PTC (Positive Temperature Coefficient) : Resettable thermal fuse resistor for over current protection

## ■ SINK (Negative) logic/SOURCE (Positive) logic (When the inverter's internal power supply is used)

Current flowing out turns control input terminals on. These are called sink logic terminals. (Type: -AN/-WN). The general used method in Europe is source logic in which current flowing into the input terminal turns it on (Typ: -WP).

Sink logic is sometimes referred to as negative logic, and source logic is referred to as positive logic. Each logic is supplied with electricity from either the inverter's internal power supply or an external power supply, and its connections vary depending on the power supply used.

<Examples of connections when the inverter's internal power supply is used>

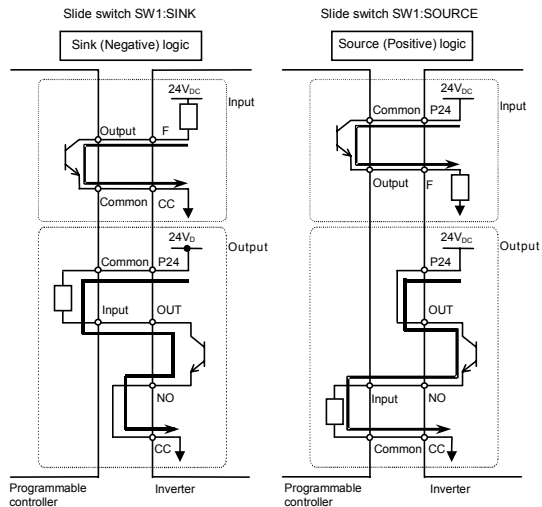

## ■ SINK (Negative) logic/SOURCE (Positive) logic (When an external power supply is used)

The PLC terminal is used to connect to an external power supply or to insulate a terminal from other input or output terminals. As for input terminals, turn the SW1 slide switch to the PLC position.

<Examples of connections when an external power supply is used>

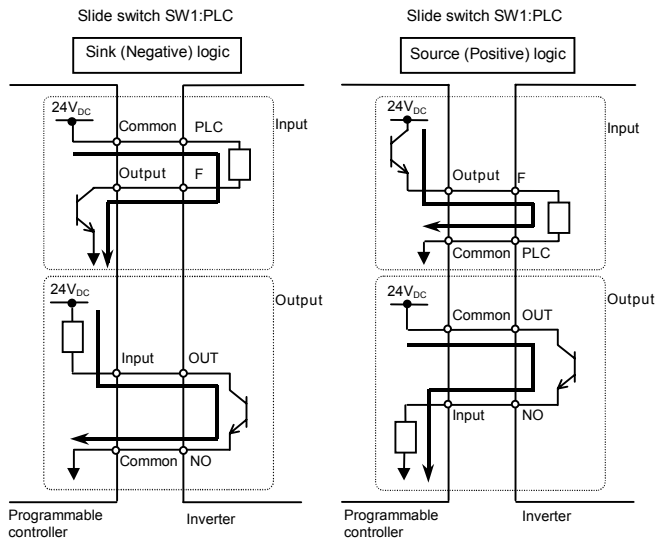

## ■ Selecting the functions of the VIA and VIB terminals between analog input and contact input

The functions of the VIA and VIB terminals can be selected between analog input and contact input by changing parameter settings ( $F_{115}$ ). (Factory default setting: Analog input)

When using these terminals as contact input terminals in a sink logic circuit, be sure to insert a resistor between the P24 and VIA terminals or between the P24 and VIB terminals. (Recommended resistance: 4.7K $\Omega$ -1/2W)

When using the VIA terminal as a contact input terminal, be sure to turn the VIA switch to the V position. If no resistor is inserted or the VIA slide switch is not turned to the V position, contact input will be left always ON, which is very dangerous.

Switch between analog input and contact input before connecting the terminals to the control circuit terminals. Otherwise the inverter or devices connected to it may be damaged.

- ☆ The figure on the right shows an example of the connection of input terminals VIA and VIB when they are used as contact input terminals. This example illustrates the connection when the inverter is used in sink (Negative) logic mode.

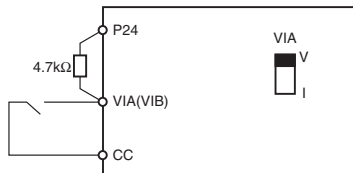

## ■ Logic switching/Voltage-current output switching (slide switch)

### (1) Logic switching

Use SW1 to switch between logics.

Switch between logics before wiring to the inverter and without supplying power. If switching between sink, source and PLC is done when power is turned on after switching or when the inverter is supplied with power, the inverter might become damaged. Confirm it before supplying power.

### (2) Voltage-current output switching

Use the FM switch to switch between voltage output and current output.

Switch the FM terminal's voltage-current output before wiring to inverter or without supplying power.

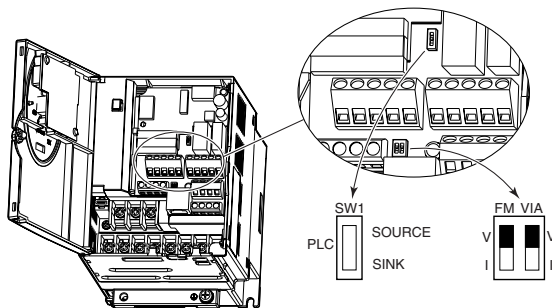

Factory default settings of slide switches



SW1 : SINK (Negative) side (WN, AN type)



SOURCE (Positive) side (WP type)

FM : V side

VIA : V side

### 3. Operations

 <b>Danger</b>	
 Prohibited	<ul style="list-style-type: none"> <li>Do not touch inverter terminals when electrical power is going to the inverter even if the motor is stopped. Touching the inverter terminals while power is connected to it may result in electric shock.</li> <li>Do not touch switches when the hands are wet and do not try to clean the inverter with a damp cloth. Such practices may result in electric shock.</li> <li>Do not go near the motor in alarm-stop status when the retry function is selected. The motor may suddenly restart and that could result in injury. Take measures for safety, e.g. attaching a cover to the motor, against accidents when the motor unexpectedly restarts.</li> </ul>
 Mandatory	<ul style="list-style-type: none"> <li>Turn power on only after attaching the front cover or closing door if enclosed in a cabinet. If power is turned on without the front cover attached or closing door if enclosed in a cabinet, that may result in electric shock or other injury.</li> <li>If the inverter begins to emit smoke or an unusual odor, or unusual sounds, immediately turn power off. If the equipment is continued in operation in such a state, the result may be fire. Call your local sales agency for repairs.</li> <li>Always turn power off if the inverter is not used for long periods of time.</li> <li>Turn input power on after attaching the front cover. When enclosed inside a cabinet and using with the front cover removed, always close the cabinet doors first and then turn power on. If the power is turned on with the front cover or the cabinet doors open, it may result in electric shock.</li> <li>Make sure that operation signals are off before resetting the inverter after malfunction. If the inverter is reset before turning off the operating signal, the motor may restart suddenly causing injury.</li> </ul>

 <b>Warning</b>	
 Contact prohibited	<ul style="list-style-type: none"> <li>Do not touch heat radiating fins or discharge resistors. These device are hot, and you'll get burned if you touch them.</li> </ul>
 Prohibited	<ul style="list-style-type: none"> <li>Observe all permissible operating ranges of motors and mechanical equipment. (Refer to the motor's instruction manual.) Not observing these ranges may result in injury.</li> </ul>

### 3.1 Simplified Operation of the VF-S11

The procedures for setting operation frequency and the methods of operation can be selected from the following.

Start / Stop

- : (1) Start and stop using the operation panel keys
- (2) Run and stop from the operation panel

Setting the frequency

- : (1) Setting using the potentiometer on the inverter main unit
- (2) Setting using the operation panel
- (3) Setting using external signals to the terminal board (0-10Vdc, 4-20mAdc)

Use the basic parameters  $\text{Cn0d}$  (Operation command mode selection),  $\text{Fn0d}$  (Speed setting mode selection).

Title	Function	Adjustment range	Default setting
$\text{Cn0d}$	Command mode selection	0: Terminal board 1: Panel	1
$\text{Fn0d}$	Frequency setting mode	0: Internal potentiometer setting 1: VIA 2: VIB 3: Operation panel 4: Serial communication 5: External contact up/down 6: VIA+VIB (Override)	0

\* See 5.4 for  $\text{Fn0d}=4, 5$  and  $6$ .

### 3.1.1 How to start and stop

[Example of a  $\text{C}rQd$  setting procedure]

Key operated	LED display	Operation
	0.0	Displays the operation frequency (operation stopped). (When standard monitor display selection $F71Q=Q$ [Operation frequency])
(MODE)	RUH	Displays the first basic parameter [History (RUH)].
(▲) (▼)	$\text{C}rQd$	Press either the $\Delta$ or $\nabla$ key to select " $\text{C}rQd$ ".
(ENT)	!	Press ENTER key to display the parameter setting. (Default setting: !).
(▲) (▼)	0	Change the parameter to 0 (terminal board) by pressing the $\Delta$ key.
(ENT)	$0 \leftrightarrow \text{C}rQd$	Press the ENTER key to save the changed parameter. $\text{C}rQd$ and the parameter set value are displayed alternately.

#### (1) Start and stop using the operation panel keys ( $\text{C}rQd = !$ )

Use the (RUN) and (STOP) keys on the operation panel to start and stop the motor.

(RUN) : Motor starts.      (STOP) : Motor stops.

★ To switch between forward run and reverse run from the control panel, the parameter  $F_r$  (forward/reverse run selection) needs to be set to 2 or 3.

#### (2) RUN/STOP by means of an external signal to the terminal board ( $\text{C}rQd = 0$ ): Sink (Negative) logic

Use external signals to the inverter terminal board to start and stop the motor.

Short **F** and **CC** terminals: run forward

Open **F** and **CC** terminals: slow down and stop

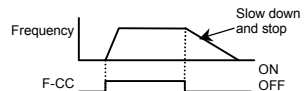

#### (3) Coast stop

The standard default setting is for slowdown stop. To make a coast stop, assign a "1(ST)" terminal function to an idle terminal using the programmable terminal function.



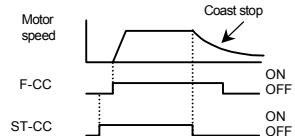

Change to  $F11Q=Q$ .

For coast stop, open the ST-CC when stopping the motor in the state described at left. The monitor on the inverter at this time will display 0.F.F.



### 3.1.2 How to set the frequency

[Example of a  $F\Delta\Delta d$  setting procedure]

Key operated	LED display	Operation
	0.0	Displays the operation frequency (operation stopped). (When standard monitor display selection $F\Delta\Delta=0$ [Operation frequency])
	RUH	Displays the first basic parameter [History (RUH)].
	$F\Delta\Delta d$	Press either the $\Delta$ key or $\nabla$ key to select " $F\Delta\Delta d$ ".
	0	Press ENTER key to display the parameter setting. (Default setting: 0).
	3	Change the parameter to 3 (Operation panel) by pressing the $\Delta$ key.
	$3\leftrightarrow F\Delta\Delta d$	Press the ENTER key to save the changed parameter. $F\Delta\Delta d$ and the parameter set value are displayed alternately.

\* Pressing the MODE key twice returns the display to standard monitor mode (displaying operation frequency).

#### (1) Setting the frequency using the potentiometer on the inverter main unit ( $F\Delta\Delta d=0$ )

Set the frequency with the notches on the potentiometer.



Move clockwise for the higher frequencies.

The potentiometer has hysteresis. So the set value may slightly change when the inverter is turned off, and then turned back on.

#### (2) Setting the frequency using the operation panel ( $F\Delta\Delta d=3$ )

Set the frequency with the operation panel..





: Moves the frequency up



: Moves the frequency down

#### ■ Example of operating a run from the panel

Key operated	LED display	Operation
	0.0	Displays the operation frequency. (When standard monitor display selection $F\Delta\Delta=0$ [Operation frequency])
	50.0	Set the operation frequency.
	50.0 $\leftrightarrow$ F $\Delta$	Press the ENT key to save the operation frequency. F $\Delta$ and the frequency are displayed alternately.
	60.0	Pressing the $\Delta$ key or the $\nabla$ key will change the operation frequency even during operation.

### (3) Setting the frequency using the operation panel ( $FREQ = 1$ or $2$ )

#### ■ Frequency setting

##### 1) Setting the frequency using external potentiometer

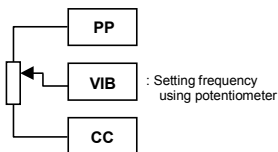

##### ★Potentiometer

Setting frequency using the potentiometer (1-10k $\Omega$ , 1/4W)  
For more detailed information on adjustments, see 6.5.

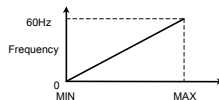

\* The input terminal VIA can be used in the same way.  
 $FREQ = 1$ : VIA effective,  $FREQ = 2$ : VIB effective  
For more details, see 6.5.

##### 2) Setting the frequency using input voltage (0~10V)

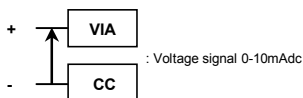

##### ★Voltage signal

Setting frequency using voltage signals (0~10V).  
For more detailed information on adjustments, see 6.5.

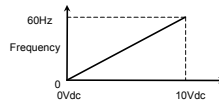

\* The input terminal VIB can be used in the same way.  
 $FREQ = 1$ : VIA effective,  $FREQ = 2$ : VIB effective  
For more details, see 6.5.

Note: Be sure to turn the VIA slide switch to the V (voltage) position.

##### 3) Setting the frequency using current input (4~20mA)

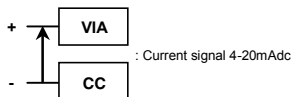

##### ★Current Signal

Current signal Setting frequency using current signals (4~20mA).  
For more detailed information on adjustments, see 6.5.

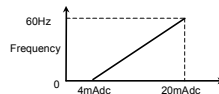

\* Setting of parameters also allow 0-20mA.

Note: Be sure to turn the VIA slide switch to the I (current) position.

## 3.2 How to operate the VF-S11

Overview of how to operate the inverter with simple examples.

### Ex.1

Setting the operation frequency using built-in potentiometer and running and stopping using the operation panel.

#### (1) Wiring

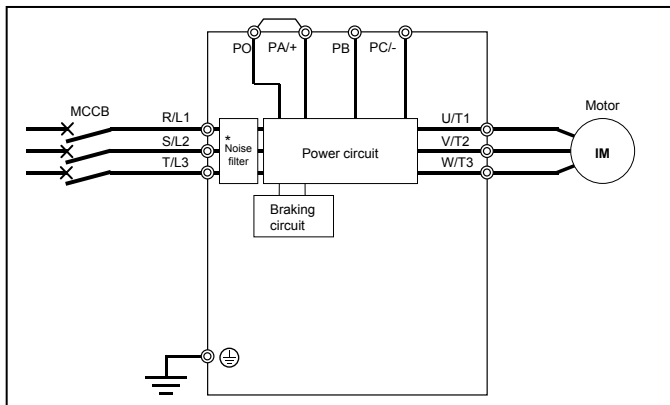

#### Parameter setting (default setting)

Title	Function	Programmed value
<i>cmd</i>	Command mode selection	1
<i>fnd</i>	Frequency setting mode selection 1	0

#### (3) Operation

Run/stop: Press the **(RUN)** and **(STOP)** keys on the panel.

Frequency setting: Set adjusting position of notches on the potentiometer.

\* 600V models have no noise filter inside.

## Ex.2

Setting the operation frequency using the operation panel and running and stopping using the operation panel.

## (1) Wiring

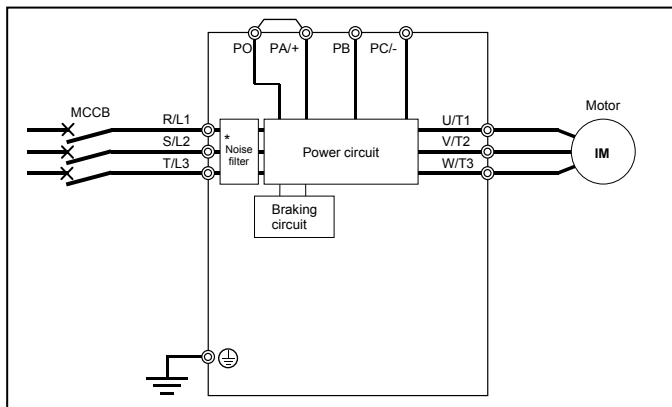

## (2) Parameter setting

Title	Function	Programmed value
<i>Command</i>	Command mode selection	1
<i>F.F.F.d</i>	Frequency setting mode selection 1	3

## (3) Operation

Run/stop: Press the (RUN) and (STOP) keys on the panel.

Frequency setting: Set with the (▲) (▼) keys on the operation panel.

To store the set frequencies in memory, press the (ENT) key.

*F.F* and the set frequency will flash on and off alternately.

\* 600V models have no noise filter inside.

## Ex.3

Setting the operation frequency using built-in potentiometer and running and stopping using external signals.

## (1) Wiring

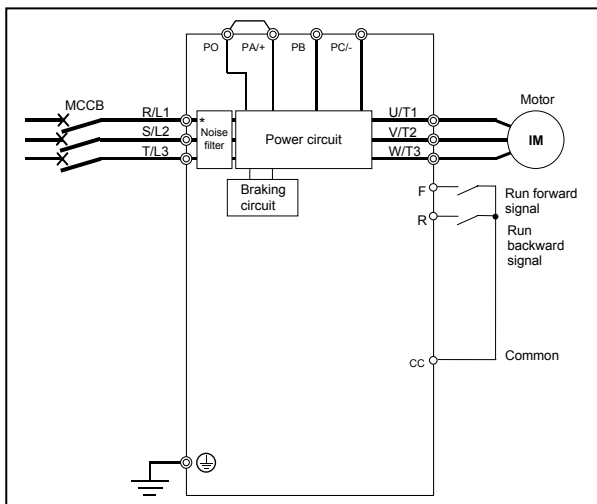

## (2) Parameter setting

Title	Function	Programmed value
<i>f00d</i>	Command mode selection	0
<i>f00d</i>	Frequency setting mode selection	0

## (3) Operation

Run/stop: ON/OFF input to F-CC, R-CC. (Set SW1 to Sink logic)

Frequency setting: Set adjusting position of notches on the potentiometer.

\* 600V models have no noise filter inside.

**Ex.4**

Operation frequency setting, running and stopping using external signals.

(1) Wiring

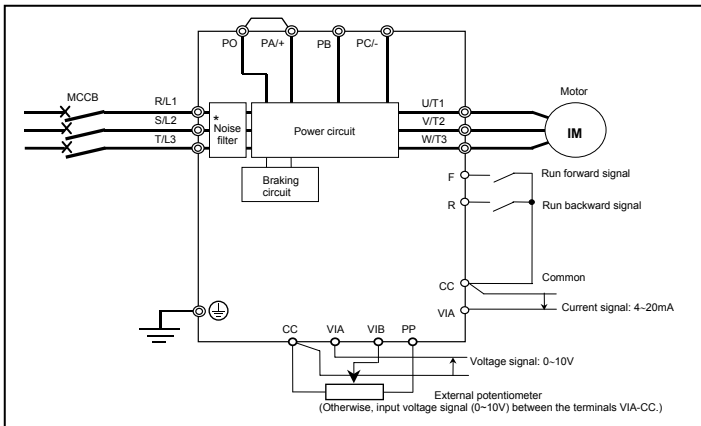

(2) Parameter setting

Title	Function	Programmed value
<i>F 0 0 d</i>	Command mode selection	0
<i>F 0 0 d</i>	Frequency setting mode selection	1or2

(3) Operation

Run/stop: ON/OFF input to F-CC, R-CC. (Set SW1 to Sink logic)

Frequency setting: VIA and VIB: 0-10Vdc (External potentiometer)

VIA: Input 4-20mAdc.

Use the VIA slide switch to switch between voltage and current to the VIA terminal.

Voltage input: V side

Current input: I side

\* 600V models have no noise filter inside.

## 4. Basic VF-S11 operations

The VF-S11 has the following four monitor modes.

Standard monitor mode

: The standard inverter mode. This mode is enabled when inverter power goes on.

This mode is for monitoring the output frequency and setting the frequency designated value. In it is also displayed information about status alarms during running and trips.

- Setting frequency designated values ⇒ see 3.1.2
- Status alarm

If there is an error in the inverter, the alarm signal and the frequency will flash alternately in the LED display.

$\zeta$ : When a current flows at or higher than the overcurrent stall level.

$P$ : When a voltage is generated at or higher than the over voltage stall level.

$L$ : When a load reaches 50% or higher of the overload trip value.

$H$ : When the temperature reaches the overheating protection alarm level.

Setting monitor mode

: The mode for setting inverter parameters.

[How to set parameters ⇒ see 4.2](#)

Status monitor mode

: The mode for monitoring all inverter status.

Allows monitoring of set frequencies, output current/voltage and terminal information.

[For more on how to use the monitor ⇒ see 8.1.](#)

Pressing the key  will move the inverter through each of the modes.

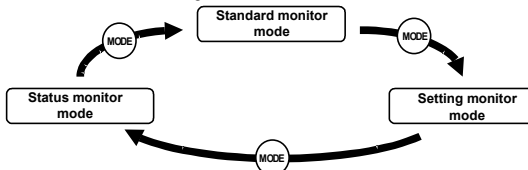

Panel jog mode

: This mode allows you to jog the motor by controlling the operation from the operation panel.  
This mode is hidden by default.

To use the panel jog mode, set the parameter  $F 2 5 2$  to  $1$ .

[Jog run mode ⇒ see 6.9](#)

# 4.1 Flow of status monitor mode

Flow of monitor as following

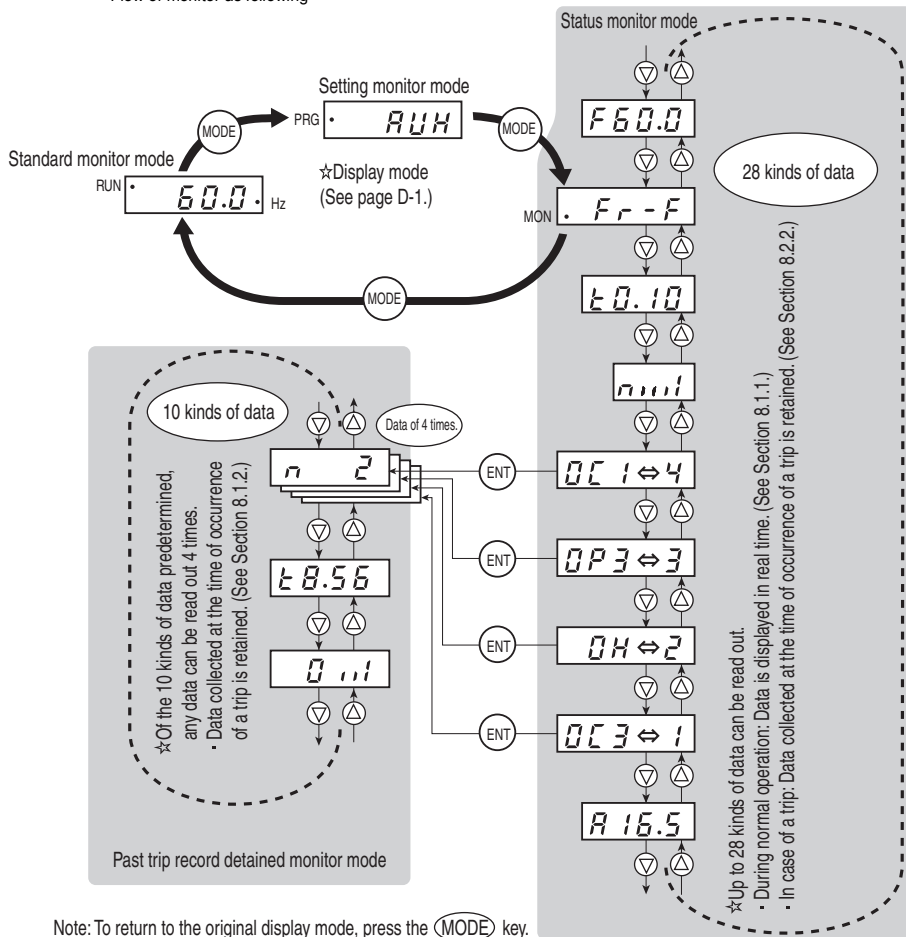

Note: To return to the original display mode, press the **MODE** key.

## 4.2 How to set parameters

The standard default parameters are programmed before the unit is shipped from the factory. Parameters can be divided into 4 major categories. Select the parameter to be changed or to be searched and retrieved.

Basic parameters

: The basic parameters that must be programmed before the first use. (See 4.2.1)

Extended parameters

: The parameters for detailed and special setting. (See 4.2.2)

User parameters

(automatic edit function)

: Indicates parameters that are different from the standard default setting parameters. Use them to check after setting and to change setting. (Parameter title:  $\overline{U}r.U$ ). (See 4.2.3)

History parameter

: This parameter has the function of displaying, in reverse chronological order, the five parameters that were changed last. This function comes in very handy when you adjust the inverter repeatedly using the same parameter. (Parameter name:  $\overline{RH}$ ). (See 4.2.4)

\* Adjustment range of parameters

$\overline{H}!$ : An attempt has been made to assign a value that is higher than the programmable range. Or, as a result of changing other parameters, the programmed value of the parameter that is now selected exceeds the upper limit.

$\overline{L}!$ : An attempt has been made to assign a value that is lower than the programmable range. Or, as a result of changing other parameters, the programmed value of the parameter that is now selected exceeds the lower limit.

If the above alarm is flashing on and off, no setting can be done of values that are equal to or greater than  $\overline{H}!$  or equal to or lower than  $\overline{L}!$ .

## 4.2.1 How to set the basic parameters





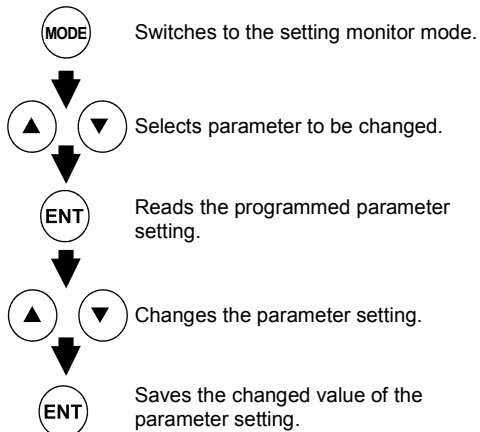



All of the basic parameters can be set by the same step procedures.

[Steps in key entry for basic parameters]



- \* Parameters were factory-set by default before shipment.
- \* Select the parameter to be changed from "Table of parameters".
- \* If there is something that you do not understand during the operation, press the MODE key to return to the  $0.0$  indication.
- \* See 11.2 for basic parameters.

Steps in setting are as follows (example of changing the maximum frequency from 80Hz to 60Hz).

Key operated	LED display	Operation
	$0.0$	Displays the operation frequency (operation stopped). (When standard monitor display selection $F \uparrow i \downarrow = 0$ [Operation frequency])
	$R U H$	The first basic parameter "R U H" (history function) is displayed.
	$F H$	Press either the $\Delta$ or $\nabla$ key to select "F H".
	$80.0$	Pressing the ENTER key reads the maximum frequency.
	$60.0$	Press the $\Delta$ key to change the maximum frequency to 60Hz.
	$80.0 \leftrightarrow F H$	Press the ENT key to save the maximum frequency. $F H$ and the frequency are displayed alternately.
After this, 	$\rightarrow$ Displays the same programmed parameter.	 $\rightarrow$ Switches to the display in the status monitor mode.
		 $\rightarrow$ Displays names of other parameters.

## 4.2.2 How to set extended parameters

The VF-S11 has extended parameters to allow you to make full use of its functions.  
All extended parameters are expressed with *F* and three digits.

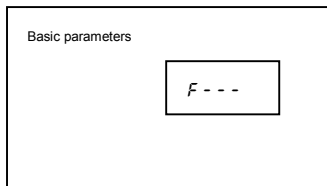

Press the MODE key once and use the ▲▼ key to select *F - - -* from the basic parameters.

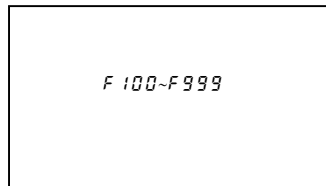
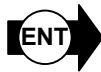

Press the ▲ key or the ▼ key to change the set value. Pressing the ENTER key allows the reading of parameter setting.

4



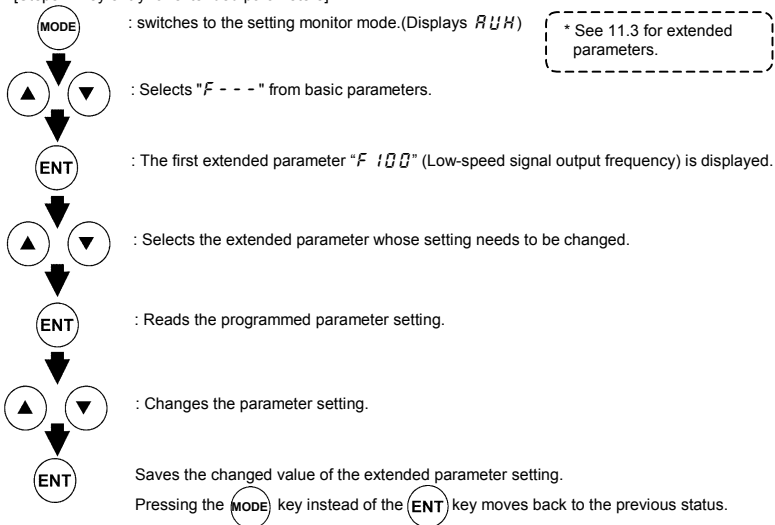



[Steps in key entry for extended parameters]



## ■ Example of parameter setting

Steps in setting are as follows

(Example of changing the dynamic braking selection  $F 304$  from 0 to 1.)

Key operated	LED display	Operation
	0.0	Displays the operation frequency (operation stopped). (When standard monitor display selection $F 710=0$ [Operation frequency])
	$RUH$	The first basic parameter " $RUH$ " (history function) is displayed.
	$F---$	Press either the $\Delta$ or the $\nabla$ to change to the parameter group $F---$ .
	$F100$	Press the ENTER key to display the first extended parameter $F100$ .
	$F304$	Press the $\Delta$ key to change to the dynamic braking selection $F304$ .
	0	Pressing the ENTER key allows the reading of parameter setting.
	1	Press the $\Delta$ key to change the dynamic braking selection from 0 to 1.
	$1 \Rightarrow F304$	Pressing the ENTER key alternately flashes on and off the parameter and changed value and allows the save of those values.

If there is anything you do not understand during this operation, press the MODE key several times to start over from the step of  $RUH$  display.

## 4.2.3 Search and resetting of changed parameters ( $\underline{C}r.U$ )



Automatically searches for only those parameters that are programmed with values different from the standard default setting and displays them in the user parameter group  $\underline{C}r.U$ . Parameter setting can also be changed within this group.















Notes on operation

- If you reset a parameter to its factory default, the parameter will no longer appear in  $\underline{C}r.U$ .
- $F7, F470 - F473$  are not appeared, if the value of these parameters are changed.

## ■ How to search and reprogram parameters

The operations of search and resetting of parameters are as follows.

Key operated	LED display	Operation
	0.0	Displays the operation frequency (operation stopped). (When standard monitor display selection $F 710=0$ [Operation frequency])
	$RUH$	The first basic parameter " $RUH$ " (history function) is displayed.
	$\underline{C}r.U$	Press $\Delta$ or $\nabla$ key to select $\underline{C}r.U$ .

Key operated	LED display	Operation
	$U - - -$	Press the ENTER key to enable the user parameter automatic edit function.
 or  	$U - - F$ ( $U - - r$ ) ↓ $ACC$	Searches for parameters that are different in value from the standard default setting and displays those parameters. Press the ENTER key or the $\Delta$ key to change the parameter displayed. (Pressing the $\nabla$ key moves the search in the reverse direction).
	$8.0$	Press the ENTER key to display the set value.
 	$5.0$	Press the $\Delta$ key and $\nabla$ key to change set value.
	$5.0 \leftrightarrow ACC$	Press the ENTER key to save the changed value. The parameter name and the programmed value will flash on and off alternately. After the change has been saved, " $U - - -$ " is displayed.
 (  )	$U - - F$ ( $U - - r$ )	Use the same steps as those given above to display parameters that you want to search for or change setting with the $\Delta$ key and $\nabla$ key.
 (  )	$Cr.U$	When $Cr.U$ appears again, the search is ended.
  	$Cr.U$ ↓ $F r - F$ ↓ $0.0$	A search can be canceled by pressing the MODE key. Press the MODE key once while the search is underway to return to the display of parameter setting mode. After that you can press the MODE key to return to the status monitor mode or the standard monitor mode (display of operation frequency).

If there is anything you do not understand during this operation, press the  key several times to start over from the step of  $RUH$  display.

## 4.2.4 Searching for a history of changes, using the history function ( $RUH$ )

History function ( $RUH$ ):

Automatically searches for 5 latest parameters that are programmed with values different from the standard default setting and displays them in the  $RUH$ . Parameter setting can also be changed within this group  $RUH$ .

Notes on operation

- If no history information is stored, this parameter is skipped and the next parameter " $RU I$ " is displayed.
- $HERd$  and  $END$  are added respectively to the first and last parameters in a history of changes.

## ■ How to use the history function

Key operated	LED display	Operation
	0.0	Displays the operation frequency (operation stopped). (When standard monitor display selection $F 7 : 0 = 0$ [Operation frequency])
(MODE)	RUH	The first basic parameter "RUH" (history function) is displayed.
(ENT)	RCC	The parameter that was set or changed last is displayed.
(ENT)	8.0	Press the ENTER key to display the set value.
(▲) (▼)	5.0	Press the $\Delta$ key and $\nabla$ key to change set value.
(ENT)	5.0 $\leftrightarrow$ RCC	Press the ENTER key to save the changed value. The parameter name and the programmed value will flash on and off alternately.
(▲) (▼)	****	Use the same steps as those given above to display parameters that you want to search for or change setting with the $\Delta$ key and $\nabla$ key.
(▲) (▼)	HERd (End)	HERd: First historic record End: Last historic record
(MODE) (MODE) (MODE)	Parameter display $\downarrow$ RUH $\downarrow$ Fr - F $\downarrow$ 0.0	Press the MODE key to return to the parameter setting mode "RUH." After that you can press the MODE key to return to the status monitor mode or the standard monitor mode (display of operation frequency).

Note) Parameter  $F 7 0 0$  (Prohibition of change of parameter settings) is not displayed in this "RUH".

## 4.2.5 Parameters that cannot be changed while running

For safety reasons, the following parameters have been set up so that they cannot be reprogrammed while the inverter is running. Stop operation ("0.0" or "0FF" is displayed) before changing parameter settings.

### [Basic parameters]

<i>RU1</i>	(Automatic acceleration/deceleration)	
<i>RU2</i>	(Parameter setting macro torque boost)	
<i>RU4</i>	(Parameter setting macro function)	
<i>CR0d</i>	(Command mode selection)	
<i>FR0d</i>	(Frequency setting mode selection 1)	} Set <i>F736</i> , and they can be changed while the inverter is running.
<i>LYP</i>	(Default setting)	
<i>FK</i>	(Maximum frequency)	
<i>uL</i>	(Base frequency 1)	
<i>uLv</i>	(Base frequency voltage1)	
<i>PL</i>	(V/F control mode selection 1)	

### [Extended parameters]

<i>F105</i>	: Priority selection
<i>F108-F118</i>	: Input terminal selection parameters
<i>F130-F139</i>	: Output terminal selection parameters
<i>F170</i>	: Base frequency 2
<i>F171</i>	: Base frequency voltage 2
<i>F261</i>	: Jog stopping pattern
<i>F301-F311</i>	: Protection parameters
<i>F316</i>	: Carrier frequency control mode selection
<i>F342-F345</i>	: Braking mode parameters
<i>F400</i>	: Auto-tuning
<i>F415-F419</i>	: Motor constant parameters
<i>F480-F496</i>	: Motor control parameters
<i>F603</i>	: Emergency stop selection
<i>F605</i>	: Output phase failure detection mode selection
<i>F608</i>	: Input phase failure detection mode selection
<i>F613</i>	: Detection of output short-circuit during start-up selection
<i>F626</i>	: Over-voltage stall protection level
<i>F627</i>	: Under voltage trip/alarm selection
<i>F669</i>	: Logic output/pulse train output selection (OUT-NO)
<i>F910-F912</i>	: PM motor parameters

The setting of any parameter other than the above can be changed even during operation.

Keep in mind, however, that when the parameter *F700* (prohibition of change of parameter settings) is set to 1 (prohibited), no parameters can be set or changed.

## 4.2.6 Returning all parameters to standard default setting

Setting the standard default setting parameter  $\xi YP=3$ , all parameters can be returned to the those factory default settings.

Note: For more details on the standard default setting parameter  $\xi YP$ , see 5.6.

### Notes on operation

- We recommend that before this operation you write down on paper the values of those parameters, because when setting  $\xi YP=3$ , all parameters with changed values will be returned to standard factory default setting.
- Note that  $F\alpha$ ,  $F\alpha 5L$ ,  $F 109$ ,  $F 470 - F 473$ ,  $F 669$  and  $F 880$  will not be reset to their factory default settings.

### ■ Steps for returning all parameters to standard default setting

Key operated	LED display	Operation
	0.0	Displays the operation frequency (perform during operation stopped).
(MODE)	RUH	The first basic parameter "RUH" (history function) is displayed.
( $\Delta$ ) ( $\nabla$ )	$\xi YP$	Press the $\Delta$ key or the $\nabla$ key to change to $\xi YP$ .
(ENT)	3 0	Pressing the ENTER key displays the programmed parameters. ( $\xi YP$ will always display "0 (zero)" on the right, the previous setting on the left.)
( $\Delta$ ) ( $\nabla$ )	3 3	Press the $\Delta$ key or the $\nabla$ key to change the set value. To return to standard factory default setting, change to "3".
(ENT)	in iE	Pressing the ENTER key displays "in iE" while returning all parameters to factory default setting.
	0.0	The monitor returns to the display of setup parameters.

If there is anything you do not understand during this operation, press the (MODE) key several times to start over from the step of RUH display.

## 4.2.7 How to save/load the user setting parameters

The current settings of all parameters can be stored (saved) in memory at a time by setting the standard setting mode selection parameter  $\xi YP$  to 7. Also, all parameter settings stored in memory can be restored (loaded) by setting parameter  $\xi YP$  to 8. This means that you can use this parameter ( $\xi YP=7$  and 8) as the parameter for your own initial settings (default settings).

## 5. Basic parameters

Before you operate the inverter, the parameters that you must first program are the basic parameters.

### 5.1 Setting acceleration/deceleration time

**$\overline{AU1}$**  : Automatic acceleration/deceleration

**$\overline{ACC}$**  : Acceleration time 1

**$\overline{DEC}$**  : Deceleration time 1

- Function
  - 1) For acceleration time  $\overline{ACC}$  programs the time that it takes for the inverter output frequency to go from 0Hz to maximum frequency  $FH$ .
  - 2) For deceleration time  $\overline{DEC}$  programs the time that it takes for the inverter output frequency to go from maximum frequency  $FH$  to 0Hz.

#### 5.1.1 Automatic acceleration/deceleration

This automatically adjusts acceleration and deceleration time in line with load size.

**$\overline{AU1}$**  = 1

- \* Adjusts the acceleration/deceleration time automatically within the range of 1/8 to 8 times as long as the time set with the  $\overline{ACC}$  or  $\overline{DEC}$ , depending on the current rating of the inverter.

**$\overline{AU1}$**  = 2

- \* Automatically adjusts speed during acceleration only. During deceleration, speed is not adjusted automatically but reduced at the rate set with  $\overline{DEC}$ .

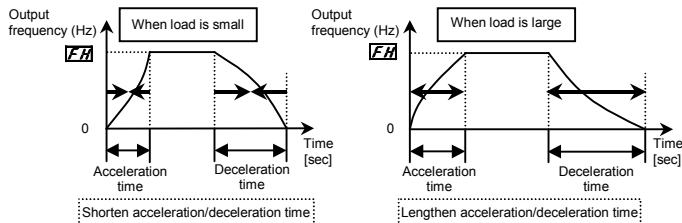

Set  $\overline{AU1}$  (automatic acceleration/deceleration) to 1 or 2.

[Parameter setting]

Title	Function	Adjustment range	Default setting
$RU1$	Automatic acceleration/deceleration	0: Disabled (manual) 1: Automatic 2: Automatic (only at acceleration)	0

- ★ When automatically setting acceleration/deceleration time, always change the acceleration/deceleration time so that it conforms to the load. The acceleration/deceleration time changes constantly with load fluctuations. For inverters that requires a fixed acceleration/deceleration time, use the manual settings ( $RLC$ ,  $dEL$ ).
- ★ Setting acceleration/deceleration time ( $RLC$ ,  $dEL$ ) in conformance with mean load allows optimum setting that conforms to further changes in load.
- ★ Use this parameter after actually connecting the motor.
- ★ When the inverter is used with a load that fluctuates considerably, it may fail to adjust the acceleration or deceleration time in time, and therefore may be tripped.

[Methods of setting automatic acceleration/deceleration]

Key operated	LED display	Operation
	$0.0$	Displays the operation frequency. (When standard monitor display selection $F710$ is set to $0$ [Operation frequency])
$\text{MODE}$	$RUH$	The first basic parameter " $RUH$ " (history function) is displayed.
$\blacktriangle$	$RU1$	Press the $\blacktriangle$ key to change the parameter to $RU1$ .
$\text{ENT}$	$0$	Pressing the ENTER key allows the reading of parameter setting.
$\blacktriangle$	$1$	Press the $\blacktriangle$ key to change the parameter to $1$ or $2$ .
$\text{ENT}$	$1 \rightarrow RU1$	Press the ENTER key to save the changed parameter. $RU1$ and the parameter are displayed alternately.

## 5.1.2 Manually setting acceleration/deceleration time

Set acceleration time from 0 (Hz) operation frequency to maximum frequency  $FH$  and deceleration time as the time when operation frequency goes from maximum frequency  $FH$  to 0 (Hz).

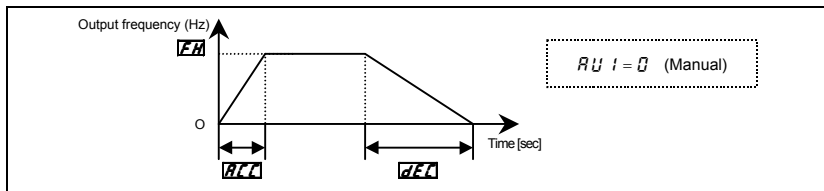

[Parameter setting]

Title	Function	Adjustment range	Default setting
$R\check{L}\check{L}$	Acceleration time 1	0.0-3200 sec.	10.0
$d\check{E}\check{L}$	Deceleration time 1	0.0-3200 sec.	10.0

Note: When the acceleration/deceleration time is set at 0.0 seconds, the inverter speed increases or reduces speed within 0.05 seconds.

☆ If the programmed value is shorter than the optimum acceleration/deceleration time determined by load conditions, overcurrent stall or overvoltage stall function may make the acceleration/deceleration time longer than the programmed time. If an even shorter acceleration/deceleration time is programmed, there may be an overcurrent trip or overvoltage trip for inverter protection. (For further details, see 13.1)

## 5.2 Increasing starting torque

$R\check{U}\check{Z}$ : Torque boost setting macro function

- Function  
Simultaneously switches inverter output (V/F) control and programs motor constants automatically (On-line automatic-tuning function) to improve torque generated by the motor. This parameter integrates the setting of special V/F control selection such as vector control.

Title	Function	Adjustment range	Default setting
$R\check{U}\check{Z}$	Torque boost setting macro function	0: Disabled 1: Automatic torque boost + auto-tuning 2: Vector control + auto-tuning 3: Energy saving + auto-tuning	0

Note: Parameter displays on the right always return to 0 after setting. The previous setting is displayed on the left.

Ex.  $\boxed{1\ 0}$

### 1) Increasing torque automatically according to the load

Set  $R\check{U}\check{Z}$  is set to 1 (automatic torque boost + auto-tuning)

When  $R\check{U}\check{Z}$  is set to 1 (automatic torque boost + auto-tuning), the inverter keeps track of the load current in any speed range and automatically adjusts the output voltage to ensure enough torque and stable operation.

Note 1: The same characteristic can be obtained by setting the V/F control mode selection parameter  $P\check{L}$  to 2 (automatic torque boost control) and the auto-tuning parameter  $F\check{4}\check{U}\check{U}$  to 2 (auto-tuning).

⇒ See 5.12

Note 2: Setting  $R\check{U}\check{Z}$  to 1 automatically programs  $P\check{L}$  to 2.

Note 3: The accuracy of auto-tuning can be increased by specifying the rated current of the driven motor, using the motor rated current setting parameter  $F\check{4}\ 1\ 5$ .

## 2) When using vector control (increasing starting torque and high-precision operations)

Set  $RU2$  to  $2$  (vector control + auto-tuning)

Setting  $RU2$  to  $2$  (vector control + auto-tuning) provides high starting torque bringing out the maximum in motor characteristics from the low-speed range. This suppresses changes in motor speed caused by fluctuations in load to provide high precision operation. This is an optimum feature for elevators and other load transporting machinery.

Note 1: The same characteristic can be obtained by setting the V/F control mode selection parameter  $Pt$  to  $3$  (vector control) and the auto-tuning parameter  $F400$  to  $2$  (auto-tuning). ⇒ See 5.12

Note 2: Setting  $RU2$  to  $2$  automatically programs  $Pt$  to  $3$ .

## 3) Energy-saving operation

$RU2$  is set to  $3$  (energy saving + auto-tuning)

When  $RU2$  is set to  $3$  (energy saving + auto-tuning), the inverter always passes a current appropriate to the load for energy saving.

Note 1: The same characteristic can be obtained by setting the V/F control mode selection parameter  $Pt$  to  $4$  (automatic energy saving) and the auto-tuning parameter  $F400$  to  $2$  (auto-tuning).

Note 2: When  $RU2$  is set to  $3$ ,  $Pt$  is automatically set to  $4$ .

[Example of parameter setting]

Key operated	LED display	Operation
	0. 0	Displays the operation frequency. (Perform during operation stopped.) (When standard monitor display selection $F710$ is set to $0$ [Operation frequency])
(MODE)	$RUH$	The first basic parameter " $RUH$ " (history function) is displayed.
(▲)	$RU2$	Press the ▲ key to change the parameter to $RU2$
(ENT)	0 0	Pressing the ENTER key allows the reading of parameter setting.
(▲)	0 3	Change the parameter setting to $3$ (energy saving + auto-tuning), using the ▲ key.
(ENT)	0 3 ⇄ $RU2$	Press the ENTER key to save the changed parameter. $RU2$ and the parameter are displayed alternately.

If vector control cannot be programmed....

First read the precautions about vector control in 5.11, 8.

- 1) If the desired torque cannot be obtained ⇒ see 6.17.1
- 2) If auto-tuning error " $Etn$ " appears ⇒ see 6.17.1

■  $R U \bar{2}$  (Torque boost setting macro function) and  $P \bar{t}$  (V/F control mode selection)

Automatic torque boost is the parameter for setting V/F control mode selection ( $P \bar{t}$ ) and auto-tuning ( $F 4 \bar{0} \bar{0}$ ) together. That is why all parameters related to change automatically when  $R U \bar{2}$  is changed.

$R U \bar{2}$	Automatically programmed parameters	
	$P \bar{t}$	$F 4 \bar{0} \bar{0}$
$\bar{0}$ Displays $\bar{0}$ after resetting	- Check the programmed value of $P \bar{t}$ .	-
$\bar{1}$ Automatic torque boost + auto-tuning	$\bar{2}$ Automatic torque boost	Executed ( $\bar{0}$ after execution)
$\bar{2}$ Vector control + auto-tuning	$\bar{3}$ Sensorless vector control	Executed ( $\bar{0}$ after execution)
$\bar{3}$ Energy saving + auto-tuning	$\bar{4}$ Energy saving	Executed ( $\bar{0}$ after execution)

#### 4) Increasing torque manually (V/F constant control)

This is the setting of constant torque characteristics that are suited for such things as conveyors. It can also be used to manually increase starting torque.

If V/F constant control is programmed after changing  $R U \bar{2}$ ,

Set V/F control mode selection  $P \bar{t} = \bar{0}$  (V/F constant).

⇒ see 5.11

Note 1: To further increase torque, increase the torque boost amount  $1 \bar{u} \bar{b}$ .

How to set the torque boost amount  $1 \bar{u} \bar{b}$

⇒ see 5.12

Note 2: V/F control selection  $P \bar{t} = 1$  (variable torque) is an effective setting for load such as fans and pumps.

⇒ see 5.11

## 5.3 Specifying an operation mode, using parameters

### ***RU4***: Parameter setting macro function

- Function  
Automatically programs all parameters (parameters described below) related to the functions by selecting the inverter's operating method.  
The major functions can be programmed simply.

[Parameter setting]

Title	Function	Adjustment range	Default setting
<i>RU4</i>	Parameter setting macro function	0: Disabled 1: Coast stop 2: 3-wire operation 3: External input UP/DOWN setting 4: 4-20mA current input operation	0:

Note: When this parameter is invoked after it has been set,  $\bar{0}$  is always displayed (on the right side).

The number on the left side refers to the number specified previously.

Example  $\bar{1} \bar{0}$

Automatically programmed functions and parameter set values

Relational parameter	Default setting value	1: Coast stop	2: 3-wire operation	3: External input UP/DOWN setting	4: 4-20mA current input operation
$\bar{C} \bar{N} \bar{0} \bar{d}$	1: Operation panel	0: Terminal board	0: Terminal board	0: Terminal board	0: Terminal board
$\bar{F} \bar{N} \bar{0} \bar{d}$	0: Potentiometer	0: Potentiometer	0: Potentiometer	5: UP/DOWN from external contact	1: VIA
$\bar{F} \bar{1} \bar{1} \bar{0}$ (Always)	1: ST	0: Disabled	1: ST	1: ST	1: ST
$\bar{F} \bar{1} \bar{1} \bar{1}$ (F)	2:F	2:F	2:F	2:F	2:F
$\bar{F} \bar{1} \bar{1} \bar{2}$ (R)	3:R	3:	3:R	3:R	3:R
$\bar{F} \bar{1} \bar{1} \bar{3}$ (RES)	10: RES	10: RES	10: RES	10: RES	10: RES
$\bar{F} \bar{1} \bar{1} \bar{4}$ (S1)	6: SS1	6: SS1	6: SS1	41: UP	6: SS1
$\bar{F} \bar{1} \bar{1} \bar{5}$ (S2)	7: SS2	7: SS2	7: SS2	42: DOWN	7: SS2
$\bar{F} \bar{1} \bar{1} \bar{6}$ (S3)	8: SS3	1: ST	49: HD	43: CLR	38: FCHG
$\bar{F} \bar{2} \bar{0} \bar{1}$	0 (%)	-	-	-	20 (%)

Note) See K-16 for input terminal functions.

Disabled ( $\bar{R} \bar{U} \bar{4} = \bar{0}$ )

The parameter does nothing. Even if set to  $\bar{0}$ , *RU4* will not return the setting you made to its factory default.

### Coast stop ( $R U 4 = 1$ )

Setting for coast stopping. In sink logic mode, closing the circuit between the S3 and CC terminals places the inverter in standby mode and opening the circuit places it in coast stop mode, because ST (standby signal) is assigned to the S3 terminal.

Refer to 3.1.1 (3) and 6.3.1 for details.

### 3-wire operation ( $R U 4 = 2$ )

Can be operated by a momentary push-button. HD (operation holding) is assigned to the terminal S3. A self-holding of operations is made in the inverter by connecting the stop switch (b-contact) to the S3 terminal and connecting the running switch (a-contact) to the F terminal or the R terminal.

#### ★ Three-wire operation (one-touch operation)

You can carry out operation by simply pressing the ON/OFF button.

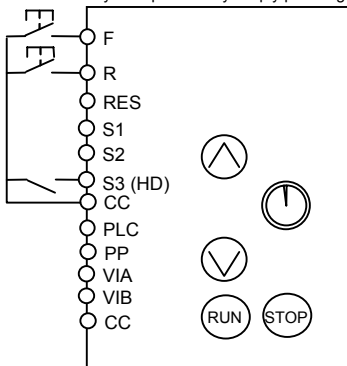

Selecting HD (operation holding) with the input terminal selection parameter

Select HD (operation holding) using the input terminal selection parameter, and turn HD on to get the inverter ready for operation or turn HD off to stop operation.

Note 1 : To carry out three-wire operation, set  $F 1 1 0$  to 1 (ST) and  $[ 1 1 0 ]$  to 0 (terminal board).

To assign HP (operation holding) to input terminal S3, set parameter  $F 1 1 6$  to 4 9 (operation holding).

Note 2 : Even if each terminal is ON, any command entered through a terminal is ignored when power is turned on (to prevent the load from starting to move unexpectedly). Enable to turn the input terminal on at power on.

Note 3 : When HD is OFF, any attempt to turn on F or R is ignored. When R is ON, you cannot start operation by turning on HD. Even when both R and HD are ON, you cannot start operation by turning on F. To start operation, turn off F and R temporarily, then turn them back on.

Note 4 : If select Jog run command during three-wire operation, inverter stops.

Note 5 : Sending out a RUN signal during DC braking has no effect in stopping DC braking.

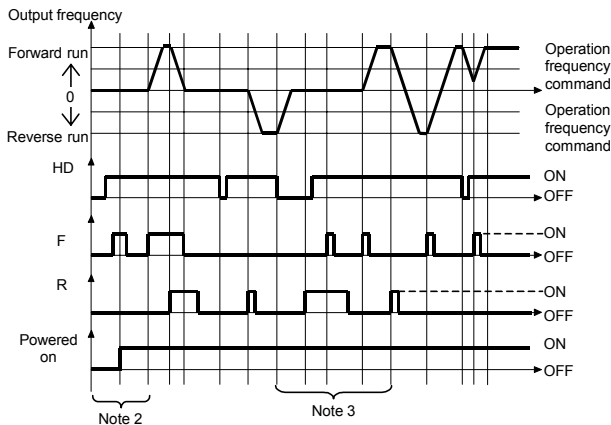

#### External input UP/DOWN setting ( $R U 4 = 3$ )

Allows setting of frequency with the input from an external contact. Can be applied to changes of frequencies from several locations.

UP (frequency up signal input from external contact) is assigned to the S1 terminal, and DOWN (frequency down signal input from external contact) are assigned to the S2 and CLR (frequency up/down clear signal input from external contact) are assigned to the S3 terminals respectively. Frequencies can be changed by input to the S1 and S2 terminals.

Refer to 6.5.3 for details.

#### 4-20 mA current input ( $R U 4 = 4$ )

Used for setting frequencies with 4-20mA current input. Switching between remote control and manual control (different frequency commands) can be made by turning on or off the S3 terminal, because FCHG (forced change of frequency commands) is assigned to the S3 terminal with priority current input.

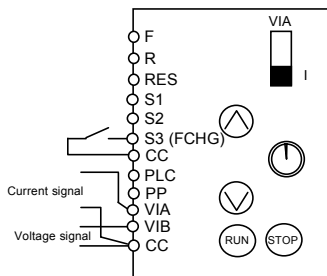

## 5.4 Selection of operation mode

**Command**: Command mode selection

**Frequency**: Frequency setting mode selection 1

- Function  
These parameters are used to specify which input device (operation panel or terminal board) takes priority in entering an operation stop command or a frequency setting command (internal potentiometer, VIA, VIB, operation panel, serial communication device, external contact up/down, VIA+VIB).

### <Command mode selection>

Title	Function	Adjustment range	Default setting
<b>Command</b>	Command mode selection	0: Terminal board 1: Operation panel	1

#### Programmed value

**0**: Terminal board operation ON and OFF of an external signal Runs and stops operation.



**1**: Operation panel operation Press the **RUN** and **STOP** keys on the operation panel to start and stop.

- \* There are two types of function: the function that conforms to commands selected by **Command**, and the function that conforms only to commands from the terminal board. See the table of input terminal function selection in Chapter 11.
- \* When priority is given to commands from a linked computer or terminal board, they have priority over the setting of **Command**.

### <Frequency setting mode selection>

Title	Function	Adjustment range	Default setting
<b>Frequency</b>	Frequency setting mode selection 1	0: Built-in potentiometer 1: VIA 2: VIB 3: Operation panel 4: Serial communication 5: UP/DOWN from external contact 6: VIA+VIB (Override)	0

[Programmed value]

- 0: **Potentiometer** The internal potentiometer to the inverter is used for setting frequencies. Turning the notches clockwise raises the frequency.
- 1: **VIA input** A frequency command is set by means of a signal from an external input device (VIA terminal: 0-10Vdc or 4-20mAdc).
- 2: **VIB input** An external signal (VIB terminal: 0-10Vdc) is used to specify a frequency command.
- 3: **Operation panel** Press the  key or the  key on either the operation panel or the expansion panel (optional) to set frequency.
- 4: **Communication** Frequencies are set by commands from an external control unit.
- 5: **UP/DOWN frequency** Terminals are used to specify an up/down frequency command.
- 6: **VIA+VIB (Override)** The sum of the values entered through the VIA and VIB terminals is used as a frequency command value.

★ No matter what value the command mode selection  $C\ N\ Q\ d$  and the frequency setting mode selection  $F\ N\ Q\ d$  are set to the control input terminal functions described below are always in operative state.

- Reset terminal (default setting: RES, valid only for tripping)
- Standby terminal (when programmed by programmable input terminal functions).
- External input tripping stop terminal command (when so set using the programmable input terminal function)

★ To make changes in the command mode selection  $C\ N\ Q\ d$  and the frequency setting mode selection 1  $F\ N\ Q\ d$ , first stop the inverter temporarily.  
(Can be changed while in operation when  $F\ 7\ 3\ 6$  is set to 0.)

### ■ Preset-speed operation

$C\ N\ Q\ d$ : Set to 0 (Terminal board).

$F\ N\ Q\ d$ : Valid in all setting values.

## 5.5 Meter setting and adjustment

**F $\bar{n}$ 5L**: Meter selection

**F $\bar{n}$** : Meter adjustment

- Function

The signal output from the FM terminal is an analog voltage signal.

For the meter, use either a full-scale 0-1mAdc ammeter or full-scale 0-7.5Vdc (or 10Vdc-1mA) voltmeter.

Switching to 0-20mAdc (4-20mAdc) output current can be made by turning the FM slide switch to the I position. When switching to 4-20mAdc current input, make adjustments using **F $\bar{5}$ 9** (analog output gradient) and **F $\bar{5}$ 92** (analog output bias).

[Connected meter selection parameters]

Title	Function	Adjustment range	Supposition output at F $\bar{n}$ 5L = I ?	Default setting
F $\bar{n}$ 5L	Meter selection	0: Output frequency 1: Output current 2: Set frequency 3: DC voltage 4: Output voltage command value 5: Input power 6: Output power 7: Torque 8: Torque current 9: Motor cumulative load factor 10: Inverter cumulative load factor 11: PBR (braking resistor) cumulative load factor 12: Frequency setting value (after PID) 13: VIA/II Input value 14: VIB Input value 15: Fixed output 1 (Output current: 100%) 16: Fixed output 2 (Output current: 50%) 17: Fixed output 3 (Other than the output current: 100%) 18: Serial communication data 19: For adjustments (F $\bar{n}$ set value is displayed.)	Maximum frequency (FH) - Maximum frequency (FH) 1.5 times of rated voltage 1.5 times of rated voltage 1.85 times of rated power 1.85 times of rated power 2.5 times of rated torque 2.5 times of rated torque Rated load factor Rated load factor Rated load factor Maximum frequency (FH) Maximum input value Maximum input value - - - - - -	0
F $\bar{n}$	Meter adjustment	-	-	-

■ Resolution

All FM terminals have a maximum of 1/1000.

■ Example of 4-20mA output adjustment (for details, see 6.20.2)

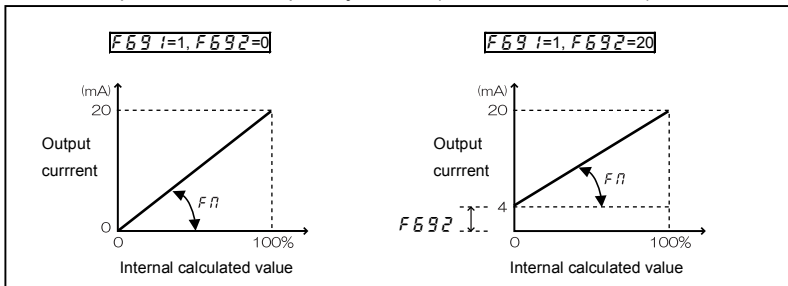

Note 1) When using the FM terminal for current output, be sure that the external load resistance is less than 750Ω.

Note 2) Note that, if  $F\ \dot{r}\ 5\ \dot{L}$  is set to 7 (torque), data will be updated at intervals of more than 40 ms.

■ Adjustment scale with parameter  $F\ \dot{r}$  (Meter adjustment)

Connect meters as shown below.

<Frequency meter>

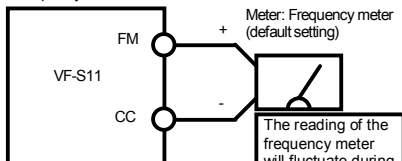

\* Optional frequency meter: QS-60T

<Ammeter>

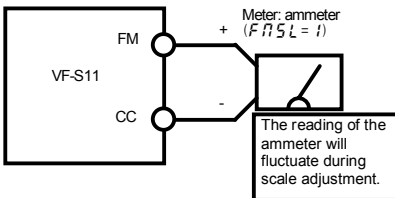

\* Make the maximum ammeter scale at least 150 percent of the inverter's rated output current.

5

[Example of how to adjustment the FM terminal frequency meter]

\* Use the meter's adjustment screw to pre-adjust zero-point.

Key operated	LED display	Operation
-	60.0	Displays the operation frequency. (When standard monitor display selection $F7iQ$ is set to 0 [Operation frequency])
(MODE)	RUH	The first basic parameter "RUH" (history function) is displayed.
(▲) (▼)	F <i>n</i>	Press either the ▲ or the ▼ key to select "F <i>n</i> ".
(ENT)	60.0	Press the ENTER key to display the operation frequency
(▲) (▼)	60.0	Press either the ▲ key or the ▼ key to adjust the meter. The meter reading will change at this time but be careful because there will be no change in the inverter's digital LED (monitor) indication.
		 <div style="border: 1px solid black; padding: 5px; display: inline-block;"> <p>[Hint] It's easier to make the adjustment if you push and hold for several seconds.</p> </div>
(ENT)	60.0 ⇔ F <i>n</i>	The adjustment is complete. F <i>n</i> and the frequency are displayed alternately.
(MODE) + (MODE)	60.0	The display returns to its original indications. (When standard monitor display selection $F7iQ$ is set to 0 [Operation frequency])

## ■ Adjusting the meter in inverter stop state

- Adjustment of output current ( $FNSL = i$ )

If, when adjusting the meter for output current, there are large fluctuations in data during adjustment, making adjustment difficult, the meter can be adjusted in inverter stop state.

When setting  $FNSL$  to  $i5$  for fixed output 1 (100% output current), a signal of absolute values will be output (inverter's rated current = 100%). In this state, adjust the meter with the  $F*n*$  (Meter adjustment) parameter.

Similarly, if you set  $FNSL$  to  $i6$  for fixed output 2 (output current at 50%), a signal that is sent out when half the inverter's rated current is flowing will be output through the FM terminal.

After meter adjustment is ended, set  $FNSL$  to  $i$  (output current).

- Adjustment of other items ( $FNSL = 0, 2$  to  $i4$ )

If parameter  $FNSL$  is set to  $i7$ : Fixed output 3 (Other than the output current: 100%), a signal that is sent out when  $FNSL$  is set to  $0, 2$  to  $i4$  (100%) will be output through the FM terminal.

100% standard value for each item is the following:

$FNSL = 0, 2, i2$	: Maximum frequency (FH)
$FNSL = 3, 4$	: 1.5 times of rated voltage
$FNSL = 5, 6$	: 1.85 times of rated power
$FNSL = 7, 8$	: 2.5 times of rated torque
$FNSL = 9, i0, i1$	: Rated load factor
$FNSL = i3, i4$	: Maximum input value

## 5.6 Standard default setting

### $\text{E} \text{Y} \text{P}$ : Default setting

- Function

Allows setting of all parameters to the standard default setting, etc. at one time.

Note that  $\text{F} \text{N}$ ,  $\text{F} \text{A} \text{S} \text{L}$ ,  $\text{F} \text{I} \text{O} \text{9}$ ,  $\text{F} \text{4} \text{7} \text{0} \sim \text{F} \text{4} \text{7} \text{3}$ ,  $\text{F} \text{6} \text{6} \text{9}$  and  $\text{F} \text{8} \text{8} \text{0}$  will not be reset to their factory default settings.

Title	Function	Adjustment range	Default setting
$\text{E} \text{Y} \text{P}$	Default setting	0: - 1: 50Hz default setting 2: 60Hz default setting 3: Standard default setting (Initialization) 4: Trip record clear 5: Cumulative operation time clear 6: Initialization of type information 7: Save user-defined parameters 8: Call user-defined parameters 9: Cumulative fan operation time record clear	0

★ This function will be displayed as 0 during reading on the right. This previous setting is displayed.

Example:  $\text{E} \text{Y} \text{P} = 0$

★  $\text{E} \text{Y} \text{P}$  cannot be set during the inverter operating. Always stop the inverter first and then program.

### Programmed value

Default setting ( $\text{E} \text{Y} \text{P} = 3$ )

Setting  $\text{E} \text{Y} \text{P}$  to 3 will return all parameters to the standard values that were programmed at the factory. (Refer to 4.2.6)

☆ When 3 is programmed,  $\text{I} \text{N} \text{I} \text{t}$  will be displayed for a short time after setting and will then be erased and displayed the original indication 0.0. Trip history data will be cleared at this time.

Trip clear ( $\text{E} \text{Y} \text{P} = 4$ )

Setting  $\text{E} \text{Y} \text{P}$  to 4 initializes the past four sets of recorded error history data.

☆ The parameter does not change.

Cumulative operation time clear ( $\text{E} \text{Y} \text{P} = 5$ )

Setting  $\text{E} \text{Y} \text{P}$  to 5 resets the cumulative operation time to the initial value (zero).

Cumulative operation time clear ( $\text{E} \text{Y} \text{P} = 6$ )

Setting  $\text{E} \text{Y} \text{P}$  to 6 clears the trips when an  $\text{E} \text{E} \text{Y} \text{P}$  format error occurs. But if the  $\text{E} \text{E} \text{Y} \text{P}$  displayed, call us.

Save user setting parameters ( $\text{tYP} = 7$ )

Setting  $\text{tYP}$  to 7 saves the current settings of all parameters. (Refer to 4.2.7)

Load user setting parameters ( $\text{tYP} = 8$ )

Setting  $\text{tYP}$  to 8 loads parameter settings to (calls up) those saved by setting  $\text{tYP}$  to 7. (Refer to 4.2.7)

☆ By setting  $\text{tYP}$  to 7 or 8, you can use parameters as your own default parameters.

Cumulative fan operation time record clear ( $\text{tYP} = 9$ )

Setting  $\text{tYP}$  to 9 resets the cumulative operation time to the initial value (zero).

Set this parameter when replacing the cooling fan, and so on.

## 5.7 Forward/reverse run selection (Operation panel operation)

**$F_r$** : Forward/reverse run selection (Operation panel operation)

- Function  
Program the direction of rotation of the motor when the running and stopping are made using the RUN key and STOP key on the operation panel.  
Valid when  $\text{CND}$  (command mode) is set to 1 (operation panel).

### Parameter setting

Title	Function	Adjustment range	Default setting
$F_r$	Forward/reverse run selection (Operation panel operation)	0: Forward run 1: Reverse run 2: Forward run (F/R switching possible) 3: Reverse run (F/R switching possible)	0

- ★ When  $F_r$  is set to 2 or 3 and an operating status is displayed, pressing the  $\triangle$  key with the  $\text{ENT}$  key held down changes the direction of rotation from reverse to forward after displaying the message " $F_r - F$ ." Pressing the  $\triangle$  key again with the  $\text{ENT}$  key held down changes the direction of rotation from forward to reverse after displaying the message " $F_r - r$ ."
- ★ Check the direction of rotation on the status monitor. For monitoring, see 8.1  
 $F_r - F$ : Forward run  
 $F_r - r$ : Reverse run
- ★ When the F and R terminals are used for switching between forward and reverse rotation from the terminal board, the  $F_r$  forward/reverse run selection parameter is rendered invalid.  
Short across the F-CC terminals: forward rotation  
Short across the R-CC terminals: reverse rotation.

- ★ The inverter was factory-configured by default so that shorting terminals F-CC and terminals R-CC simultaneously would cause the motor to slow down to a stop. Using parameter  $F105$ , however, you can choose between stop and reverse run.  
Using the parameter  $F105$ , however, you can select between forward run and reverse run.
- ★ This function is valid only when  $CND$  is set to 1 (operation panel).

## 5.8 Maximum frequency

$FH$ : Maximum frequency

- Function
  - 1) Programs the range of frequencies output by the inverter (maximum output values).
  - 2) This frequency is used as the reference for acceleration/deceleration time.

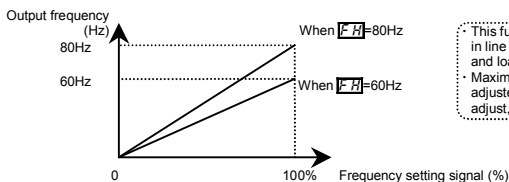

This function determines the value in line with the ratings of the motor and load.  
Maximum frequency cannot be adjusted during operation. To adjust, first stop the inverter.

- ★ If  $FH$  is increased, adjust the upper limit frequency  $UL$  as necessary.

### Parameter setting

Title	Function	Adjustment range	Default setting
$FH$	Maximum frequency	30.0-500.0 (Hz)	80.0

## 5.9 Upper limit and lower limit frequencies

$UL$ : Upper limit frequency

$LL$ : Lower limit frequency

- Function
 

Programs the lower limit frequency that determines the lower limit of the output frequency and the upper limit frequency that determines the upper limit of that frequency.

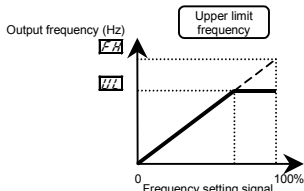

\* Frequencies that go higher than  $UL$  will not be output.

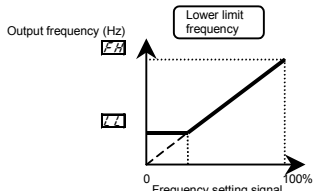

\* The output frequency cannot be set at less than  $LL$ .

### Parameter setting

Title	Function	Adjustment range	Factory default setting
$UL$	Upper limit frequency	0.5 - $FH$ (Hz)	50.0 (WP type) 60.0 (WN, AN type)
$LL$	Lower limit frequency	0.0 - $UL$ (Hz)	0.0

## 5.10 Base frequency

$UL$ : Base frequency 1

$ULU$ : Base frequency voltage 1

- Function  
Sets the base frequency and the base frequency voltage in conformance with load specifications or the Base frequency.

Note: This is an important parameter that determines the constant torque control area.

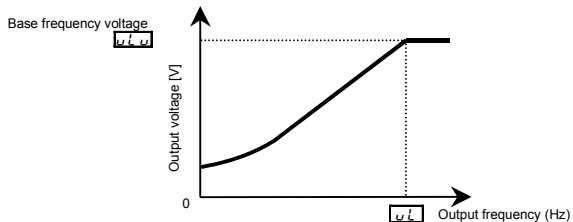

Title	Function	Adjustment range	Factory default setting
$UL$	Base frequency 1	25.0-500.0 (Hz)	50.0 (WP type) 60.0 (WN, AN type)
$ULU$	Base frequency voltage1	50-330 (V) : 240V class 50-660 (V) : 500/600V class	230 (240V class) 460 (500V class) 575 (600V class)

## 5.11 Selecting control mode

**P<sub>Ł</sub>**: V/F control mode selection

- Function
    - With VF-S11, the V/F controls shown below can be selected.
    - V/F constant
    - Variable torque
    - Automatic torque boost control \*1
    - Vector control \*1
    - Energy saving \*1
    - Dynamic energy-saving (for fans and pumps)
    - PM motor control
- (\*1) Parameter setting macro torque boost: **R<sub>U</sub>Z** parameter can automatically set this parameter and auto-tuning at a time.





### ■ Parameter setting

Title	Function	Adjustment range	Default setting
<b>P<sub>Ł</sub></b>	V/F control mode selection	0: V/F constant 1: Variable torque 2: Automatic torque boost control 3: Vector control 4: Energy-saving 5: Dynamic energy-saving (for fans and pumps) 6: PM motor control	2

Steps in setting are as follows

(In this example, the V/F control mode selection parameter **P<sub>Ł</sub>** is set to **3** (Vector control).)

[Setting V/F control mode selection to 3 (sensorless vector control)]

Key operated	LED display	Operation
	<b>0. 0</b>	Displays the operation frequency. (Perform during operation stopped.) (When standard monitor display selection <b>F 7 10</b> is set to <b>0</b> [Operation frequency])
	<b>R U H</b>	The first basic parameter "R U H" (history function) is displayed.
	<b>P Ł</b>	Press the $\Delta$ key to change the parameter to <b>P Ł</b> (V/F control mode selection).
	<b>2</b>	Press the ENTER key to display the parameter setting. (Standard default setting: <b>2</b> (automatic torque boost control)).
	<b>3</b>	Press the $\Delta$ key to change the parameter to <b>3</b> (vector control).
	<b>3</b> $\leftrightarrow$ <b>P Ł</b>	Press the ENTER key to save the changed parameter. <b>P Ł</b> and parameter set value " <b>3</b> " are displayed alternately.

**Warning:**

When setting the V/F control mode selection parameter ( $P_{\xi}$ ) to any number between  $\xi$  and  $\delta$ , be sure to set at least the following parameters.

$F_{415}$  (Motor rated current): See the motor's nameplate.

$F_{416}$  (No-load current of motor): Refer to the motor test report.

$F_{417}$  (Rated rotational speed of motor): See the motor's nameplate.

Set also other torque boost parameters ( $F_{401}$  to  $F_{496}$ ), as required.

**1) Constant torque characteristics**

Setting of V/F control mode selection  $P_{\xi}$  to  $\xi$  (V/F constant)

This is applied to loads with equipment like conveyors and cranes that require the same torque at low speeds as at rated speeds.

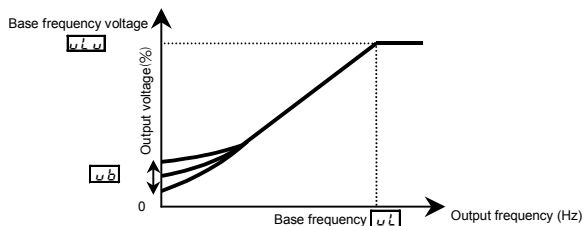

\* To increase the torque further, increase the setting value of the manual torque boost  $u.b.$

⇒ For more details, see 5.12.

**2) Setting for fans and pumps**

Setting of V/F control mode selection  $P_{\xi}$  to  $\zeta$  (variable torque)

This is appropriate for load characteristics of such things as fans, pumps and blowers in which the torque in relation to load rotation speed is proportional to its square.

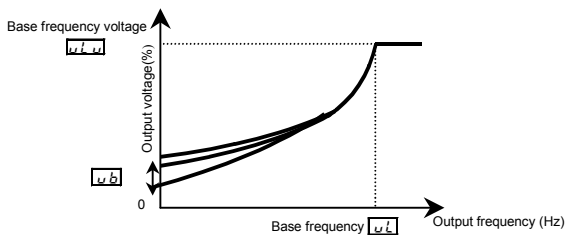

### 3) Increasing starting torque

Setting of V/F control mode selection  $P\bar{L}$  to  $\bar{2}$  (automatic torque boost control)

Detects load current in all speed ranges and automatically adjusts voltage output (torque boost) from inverter. This gives steady torque for stable runs.

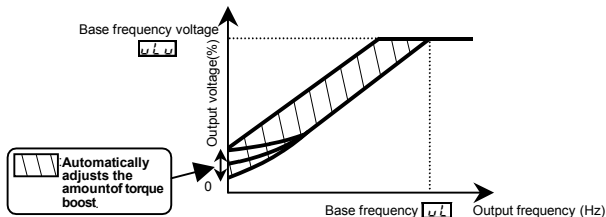

Note: This control system can oscillate and destabilize runs depending on the load. If that should happen, set V/F control mode selection  $P\bar{L}$  to  $\bar{0}$  (V/F constant) and increase torque manually.

### ★ Motor constant must be set

If the motor you are using is a 4P Toshiba standard motor and if it has the same capacity as the inverter, there is basically no need to set the motor constant. In any other case, be sure to set the parameters  $F\bar{4}\bar{1}\bar{5}$  to  $F\bar{4}\bar{1}\bar{7}$  properly.

Be sure to set  $F\bar{4}\bar{1}\bar{5}$  (rated current of motor) and  $F\bar{4}\bar{1}\bar{7}$  (rated speed of motor) correctly, as specified on the motor's nameplate. For the setting of  $F\bar{4}\bar{1}\bar{5}$  (no-load current of motor), refer to the motor test report. There are three procedures for setting the other motor constants.

- 1) Auto torque boost and a motor constant (auto-tuning) can be set at once.  
To do so, set the basic parameter  $\bar{R}\bar{U}\bar{2}$  to  $\bar{1}$ . ⇒ For details, see 1 in 5.2.
- 2) The motor constant can be automatically set (auto-tuning). Set the extended parameter  $F\bar{4}\bar{0}\bar{0}$  to  $\bar{2}$ .  
⇒ For details, see selection 2 in 6.17.
- 3) Each motor constant can be set individually. ⇒ For details, see selection 3 in 6.17.

### 4) Vector control - increasing starting torque and achieving high-precision operation.

Setting of V/F control mode selection  $P\bar{L}$  to  $\bar{3}$  (Vector control)

Using sensor-less vector control with a Toshiba standard motor will provide the highest torque at the low speed ranges.

- (1) Provides large starting torque.
- (2) Effective when stable operation is required to move smoothly up from the low speeds.
- (3) Effective in elimination of load fluctuations caused by motor slippage.

### ★ Motor constant must be set

If the motor you are using is a 4P Toshiba standard motor and if it has the same capacity as the inverter, there is basically no need to set the motor constant. In any other case, be sure to set the parameters  $F415$  to  $F417$  properly.

Be sure to set  $F415$  (rated current of motor) and  $F417$  (rated speed of motor) correctly, as specified on the motor's nameplate. For the setting of  $F416$  (no-load current of motor), refer to the motor test report. There are three procedures for setting the other motor constants.

- 1) The sensorless vector control and motor constants (auto-tuning) can be set at a time.  
Set the basic parameter  $R42$  to 2. ⇒ For details, see 1 in 5.2.
- 2) The motor constant can be automatically set (auto-tuning).  
Set the extended parameter  $F400$  to 2. ⇒ For details, see selection 2 in 6.17.
- 3) Each motor constant can be set individually. ⇒ For details, see selection 3 in 6.17.

### 5) Energy-saving

Setting of V/F control mode selection  $P4$  to 4 (Energy-saving)

Energy can be saved in all speed areas by detecting load current and flowing the optimum current that fits the load.

### ★ Motor constant must be set

If the motor you are using is a 4P Toshiba standard motor and if it has the same capacity as the inverter, there is no need to set the motor constant. In any other case, be sure to set the parameters  $F415$  to  $F417$  properly.

Be sure to set  $F415$  (rated current of motor) and  $F417$  (rated speed of motor) correctly, as specified on the motor's nameplate. For the setting of  $F416$  (no-load current of motor), refer to the motor test report. There are three procedures for setting the other motor constants.

- 1) Automatic energy-saving operation and a motor constant can be set at once. Set the basic parameter  $R42$  to 3.  
⇒ For details, see 1 in 5.2.
- 2) The motor constant can be automatically set (auto-tuning). Set the extended parameter  $F400$  to 2.  
⇒ For details, see selection 2 in 6.17.
- 3) Each motor constant can be set individually. ⇒ For details, see selection 3 in 6.17.

### 6) Achieving further energy savings

Setting of V/F control mode selection  $P4$  to 5 (Dynamic energy-saving)

More substantial energy savings than those provided by setting  $P4$  to 4 can be achieved in any speed range by keeping track of the load current and passing a current appropriate to the load. The inverter cannot respond to rapid load fluctuations, so that this feature should be used only for loads, such as fans and pumps, that are free of violent load fluctuations.

### ★ Motor constant must be set

If the motor you are using is a 4P Toshiba standard motor and if it has the same capacity as the inverter, there is no need to set the motor constant. In any other case, be sure to set the parameters  $F415$  to  $F417$  properly.

Be sure to set  $F415$  (rated current of motor) and  $F417$  (rated speed of motor) correctly, as specified on the motor's nameplate. For the setting of  $F416$  (no-load current of motor), refer to the motor test report.

For other types of motors, there are two ways to set a motor constant.

- 1) The motor constant can be set automatically (auto-tuning). Set the extended parameter  $F400$  to 2.
  - ⇒ For details, see selection 2 in 6.17.
- 2) Each motor constant can be set individually
  - ⇒ For details, see selection 3 in 6.17.

### 7) Operating a permanent magnet motor

Setting of V/F control mode selection  $P6$  to 6 (PM motor control)

Permanent magnet motors (PM motors) that are light, small in size and highly efficient, as compared to induction motors, can be operated in sensor-less operation mode.

Note that this feature can be used only for specific motors. For more information, contact your Toshiba dealer.

### 8) Precautions on vector control

- 1) When exercising vector control, be sure to set the extended parameters  $F415$  to  $F417$  properly. Be sure to set  $F415$  (rated current of motor) and  $F417$  (rated speed of motor) correctly, as specified on the motor's nameplate. For the setting of  $F416$  (no-load current of motor), refer to the motor test report.
- 2) The sensorless vector control exerts its characteristics effectively in frequency areas below the base frequency ( $f_b$ ). The same characteristics will not be obtained in areas above the base frequency.
- 3) Set the base frequency to anywhere from 40 to 120Hz during vector control ( $P6=3$ ).
- 4) Use a general purpose squirrel-cage motor with a capacity that is the same as the inverter's rated capacity or one rank below.

The minimum applicable motor capacity is 0.1kW.

- 5) Use a motor that has 2-8 P.
- 6) Always operate the motor in single operation (one inverter to one motor). Sensorless vector control cannot be used when one inverter is operated with more than one motor.
- 7) The maximum length of wires between the inverter and motor is 30 meters. If the wires are longer than 30 meters, set standard auto-tuning with the wires connected to improve low-speed torque during sensorless vector control.
 

However the effects of voltage drop cause motor-generated torque in the vicinity of rated frequency to be somewhat lower.
- 8) Connecting a reactor or surge voltage suppression filter between the inverter and the motor may reduce motor-generated torque. Setting auto-tuning may also cause a trip ( $E6n$ ) rendering sensorless vector control unusable.

### 9) The following table shows the relationship between the V/F control mode selection ( $P6$ ) and the motor constant parameter.

Under normal conditions, be sure to set or adjust the parameters marked with ⊙.

When making detailed settings, adjust the parameters marked with ○ as well, if necessary.

Do not adjust the parameters marked with ×, because they are invalid.

(For instructions about how to adjust the parameter  $F400$  and later, see section 6.17.)

## Relationship between V/F control mode selection ( $P\tau$ ) and Motor constant parameter

⊙&○ : Valid, × : Invalid

Title	Function	Parameter $P\tau$ (V/F control mode selection)					
		0 V/F constant	1 Variable torque	2 Automatic torque boost control	3 Vector control	4 Energy- saving	5 Dynamic energy- saving
$P42$	Torque boost setting macro function	×	×	○	○	○	×
$\omega L$	Base frequency 1	⊙	⊙	⊙	⊙	⊙	⊙
$\omega L \omega$	Base frequency voltage 1	⊙	⊙	⊙	⊙	⊙	⊙
$\omega b$	Torque boost value 1	⊙	⊙	×	×	×	×
$F170$	Base frequency 2	○	×	×	×	×	×
$F171$	Base frequency voltage 2	○	×	×	×	×	×
$F172$	Torque boost value 2	○	×	×	×	×	×
$F400$	Auto-tuning	×	×	○	○	○	○
$F401$	Slip frequency gain	×	×	×	○	×	×
$F402$	Automatic torque boost value	×	×	⊙	⊙	⊙	⊙
$F415$	Motor rated current	○	○	⊙	⊙	⊙	⊙
$F416$	Motor no-load current	×	×	○	○	○	○
$F417$	Motor rated speed	○	○	⊙	⊙	⊙	⊙
$F418$	Speed control response coefficient	×	×	○	○	○	○
$F419$	Speed control stability coefficient	×	×	○	○	○	○
$F480$	Exciting current coefficient	×	×	○	○	×	×
$F485$	Stall prevention control coefficient 1	○	○	○	○	○	○
$F492$	Stall prevention control coefficient 2	○	○	○	○	○	○
$F494$	Motor adjustment coefficient	○	○	○	○	○	○
$F495$	Maximum voltage adjustment coefficient	○	○	○	○	○	○
$F496$	Waveform switching adjustment coefficient	○	○	○	○	○	○

⊙ : Be sure to set and adjust the parameters.

○ : Adjust the parameters if necessary.

## 5.12 Manual torque boost - increasing torque boost at low speeds

**ub**: Torque boost 1

- Function  
If torque is inadequate at low speeds, increase torque by raising the torque boost rate with this parameter.

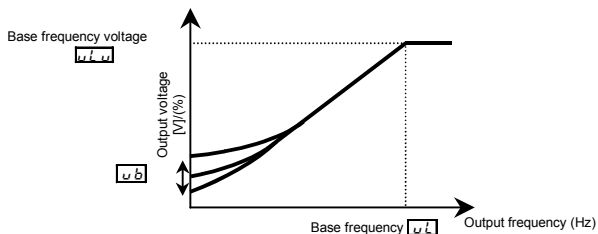

[Parameters]

Title	Function	Adjustment range	Default setting
ub	Torque boost 1	0.0 - 30.0 (%)	According to model (See Chapter 11, K-15)

★ Valid when  $P\tau$  is set to  $\bar{v}$  (V/F constant) or  $t$  (square reduction)

Note 1: The optimum value is programmed for each inverter capacity. Be careful not to increase the torque boost rate too much because it could cause an overcurrent trip at startup.

## 5.13 Setting the electronic thermal

**EHF**: Motor electronic-thermal protection level 1

**ETT**: Electronic thermal protection characteristic selection

**F173**: Motor electronic-thermal protection level 2

**F507**: Motor 150%-overload time limit

- Function  
This parameter allows selection of the appropriate electronic thermal protection characteristics according to the particular rating and characteristics of the motor.

## Parameter setting

Title	Function	Adjustment range				Default setting
$\underline{tHr}$	Motor electronic thermal protection level 1	10 – 100 (%) / (A)				100
$\underline{OLN}$	Electronic-thermal protection characteristic selection	Setting value		Overload protection	Overload stall	○
		0	Standard motor	○	×	
		1		○	○	
		2		×	×	
		3		×	○	
		4	VF motor (special motor)	○	×	
		5		○	○	
		6		×	×	
7	×	○				
$F173$	Motor electronic-thermal protection level 2	10 – 100 (%) / (A)				100
$F607$	Motor 150%-overload time limit	10 – 2400 (s)				300

\* ○ : valid, × : invalid

5

### 1) Setting the electronic thermal protection characteristics selection $\underline{OLN}$ and motor electronic thermal protection level 1 $\underline{tHr}$ , 2 $F173$

The electronic thermal protection characteristics selection  $\underline{OLN}$  is used to enable or disable the motor overload trip function ( $\underline{OL2}$ ) and the overload stall function.

While the inverter overload trip ( $\underline{OL1}$ ) will be in constant detect operation, the motor overload trip ( $\underline{OL2}$ ) can be selected using the parameter  $\underline{OLN}$ .

#### Explanation of terms

**Overload stall:** This is an optimum function for equipment such as fans, pumps and blowers with variable torque characteristics that the load current decreases as the operating speed decreases.

When the inverter detects an overload, this function automatically lowers the output frequency before the motor overload trip  $\underline{OL2}$  is activated. This function operates a motor at frequencies that allow the load current to keep its balance so that the inverter can continue operation without being tripped.

**Note:** Do not use the overload stall function with loads having constant torque characteristics (such as conveyor belts in which load current is fixed with no relation to speed).

### [Using standard motors (other than motors intended for use with inverters)]

When a motor is used in the lower frequency range than the rated frequency, that will decrease the cooling effects for the motor. This speeds up the start of overload detection operations when a standard motor is used in order to prevent overheating.

### ■ Setting of electronic thermal protection characteristics selection $0L7$

Setting value	Overload protection	Overload stall
0	○	×
1	○	○
2	×	×
3	×	○

○ : valid, × : invalid

### ■ Setting of motor electronic thermal protection level $1\text{tHr}$ (Same as $E173$ )

If the capacity of the motor is smaller than the capacity of the inverter, or the rated current of the motor is smaller than the rated current of the inverter, adjust the electronic thermal protection level  $1\text{tHr}$  so that it fits the motor's rated current.

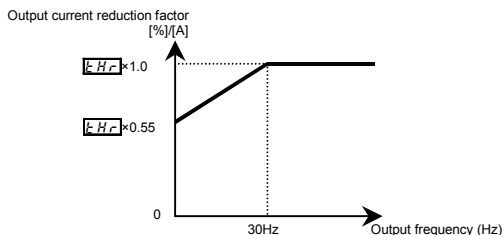

Note: The motor overload protection start level is fixed at 30Hz.

[Example of setting: When the VFS11-2007PM is running with a 0.4kW motor having 2A rated current]

Key operated	LED display	Operation
	0.0	Displays the operation frequency. (Perform during operation stopped.) (When standard monitor display selection $F710$ is set to 0 [Operation frequency])
(MODE)	$RUH$	The first basic parameter " $RUH$ " (history function) is displayed.
(▲) (▼)	$1\text{tHr}$	Press either the $\Delta$ key or the $\nabla$ key to change the parameter to $1\text{tHr}$ .
(ENT)	100	Press the ENTER key to display the parameter setting. (Standard default setting: 100%)
(▲) (▼)	42	Press the $\Delta$ key to change the parameter to 42% (=motor rated current/inverter output rated current x 100=2.0/4.8x100).
(ENT)	42 $\leftrightarrow$ $1\text{tHr}$	Press the ENTER key to save the changed parameter. $1\text{tHr}$ and the parameter are displayed alternately.

Note: The rated output current of the inverter should be calculated from the rated current for frequencies below 4kHz, regardless of the setting of the PWM carrier frequency parameter ( $F300$ ).

[Using a VF motor (motor for use with inverter)]

■ Setting of electronic thermal protection characteristics selection  $\mathbb{D}\mathbb{L}\mathbb{7}$

Setting value	Overload protection	Overload stall
4	○	×
5	○	○
6	×	×
7	×	○

○ : valid, × : invalid

VF motors (motors designed for use with inverters) can be used in frequency ranges lower than those for standard motors, but their cooling efficiency decreases at frequencies below 6Hz.

■ Setting of motor electronic thermal protection level  $1\mathbb{E}\mathbb{H}\mathbb{r}$  (Same as  $\mathbb{F}\mathbb{1}\mathbb{7}\mathbb{3}$ )

If the capacity of the motor is smaller than the capacity of the inverter, or the rated current of the motor is smaller than the rated current of the inverter, adjust the electronic thermal protection level  $1\mathbb{E}\mathbb{H}\mathbb{r}$  so that it fits the motor's rated current.

\* If the indications are in percentages (%), then 100% equals the inverter's rated output current (A).

Output current reduction factor [%]/[A]

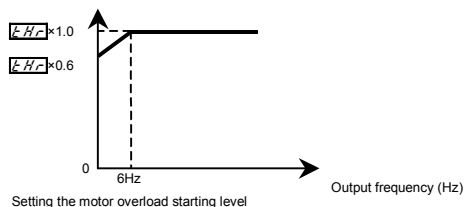

2) Motor 150%-overload time limit  $\mathbb{F}\mathbb{6}\mathbb{0}\mathbb{7}$

Parameter  $\mathbb{F}\mathbb{6}\mathbb{0}\mathbb{7}$  is used to set the time elapsed before the motor trips under a load of 150% (overload trip  $\mathbb{D}\mathbb{L}\mathbb{2}$ ) within a range of 10 to 2400 seconds.

3) Inverter over load characteristics

Set to protect the inverter unit. Cannot be changed or turned off by parameter setting.

To prevent the inverter overload trip function ( $\mathbb{D}\mathbb{L}\mathbb{1}$ ) from being activated too easily, lower the stall prevention level ( $\mathbb{F}\mathbb{6}\mathbb{0}\mathbb{1}$ ) or increase the acceleration time ( $\mathbb{R}\mathbb{L}\mathbb{L}$ ) or deceleration time ( $\mathbb{d}\mathbb{E}\mathbb{L}$ ).

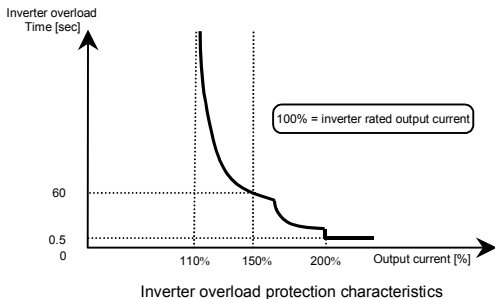

\* To protect the inverter, overload trip or overcurrent trip activate in a short period of time when output current reaches 150% or higher.

## 5.14 Preset-speed operation (speeds in 15 steps)

**5r1** - **5r7**: Preset-speed operation frequencies 1-7

**F287** - **F294**: Preset-speed operation frequencies 8-15

- Function

A maximum of 15 speed steps can be selected just by switching an external contact signal. Multi-speed frequencies can be programmed anywhere from the lower limit frequency  $\underline{LL}$  to the upper limit frequency  $\underline{UL}$ .

When fire-speed control is assigned to the terminal board, the function of setting fire-speed operation frequencies is assigned to **F294**. See 6.11.2, "Fire-speed control."

[Setting method]

1) Run/stop

The starting and stopping control is done from the terminal board.

Title	Function	Adjustment range	Setting value
<b>Fn0d</b>	Command mode selection	0: Terminal board 1: Operation panel	0

Note: If speed commands (analog signal or digital input) are switched in line with preset-speed operations, select the terminal board using the frequency setting mode selection **Fn0d**. ⇒ See 3) or 5.4

2) Preset-speed frequency setting

Set the speed (frequency) of the number of steps necessary.

Setting from speed 1 to speed 7

Title	Function	Adjustment range	Setting value
<b>5r1-5r7</b>	Preset-speed operation frequencies 1-7	$\underline{LL}$ - $\underline{UL}$ (Hz)	0.0

## Setting from speed 8 to speed 15

Title	Function	Adjustment range	Setting value
<i>F287 - F294</i>	Preset-speed operation frequencies 8-15	<i>LL - UL</i> (Hz)	0.0

Examples of preset-speed contact input signals: Slide switch SW1 set to sink logic

O: ON -: OFF (Speed commands other than preset-speed commands are valid when all are OFF)

Terminal	Preset-speed														
	1	2	3	4	5	6	7	8	9	10	11	12	13	14	15
S1-CC	○	-	○	-	○	-	○	-	○	-	○	-	○	-	○
S2-CC	-	○	○	-	-	○	○	-	-	○	○	-	-	○	○
S3-CC	-	-	-	○	○	○	○	-	-	-	-	○	○	○	○
RES-CC	-	-	-	-	-	-	-	○	○	○	○	○	○	○	○

★ Terminal functions are as follows.

- Terminal S1..... Input terminal function selection 4 (S1)  
*F i 4 = 5* (Preset-speed command 1: SS1)
- Terminal S2..... Input terminal function selection 5 (S2)  
*F i 5 = 7* (Preset-speed command 2: SS2)
- Terminal S3..... Input terminal function selection 6 (S3)  
*F i 6 = 8* (Preset-speed command 3: SS3)
- Terminal RES..... Input terminal function selection 3 (RES)  
*F i 3 = 9* (Preset-speed command 4: SS4)

★ SS4 is not allocated to standard default setting. Use the input terminal function selection to allocate SS4 an idle terminal. In the above example the RES terminal is used for SS4.

[Example of a connection diagram]  
(SW1 set to sink logic)

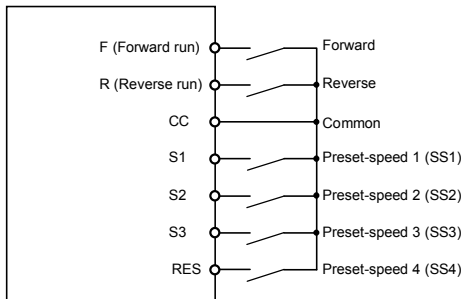

3) Using other speed commands with preset-speed command

Command mode selection <i>F r 0 d</i>		0: Terminal board				1: Operation panel			
Frequency setting mode selection <i>F r 0 d</i>		0: Built-in potentiometer	1: VIA 2: VIB 5: UP/DOWN or 6: VIA + VIB	3: Operation panel	4: Communication	0: Built-in potentiometer	1: VIA 2: VIB 5: UP/DOWN or 6: VIA + VIB	3: Operation panel	4: Communication
Preset-speed command	Entered	Preset-speed command valid Note)				Potentiometer command valid	Terminal command valid	Operation panel command valid	Communication command valid
	Not entered	Potentiometer command valid	Terminal command valid	Operation panel command valid	Communication command valid	(The inverter doesn't accept Preset-speed command.)			

Note) The preset-speed command is always given priority when other speed commands are input at the same time.

Below is an example of 7-step speed operation with standard default setting.

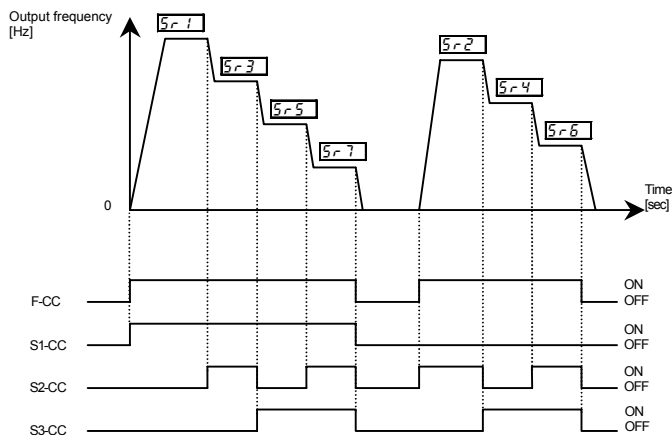

Example of 7-step speed operation

5

## 6. Extended parameters

Extended parameters are provided for sophisticated operation, fine adjustment and other special purposes. Modify parameter settings as required. See Section 11, Table of extended parameters.

### 6.1 Input/output parameters

#### 6.1.1 Low-speed signal

**F 100**: Low-speed signal output frequency

- Function
  - When the output frequency exceeds the setting of **F 100** an ON signal will be generated. This signal can be used as an electromagnetic brake excitation/release signal. This signal can also be used as an operation signal when **F 100** is set to 0.0Hz, because an ON signal is put out if the output frequency exceeds 0.0Hz.
  - ★ Relay output (250Vac-1A (cosφ=1), 30Vdc-0.5A, 250Vac-0.5A (cosφ=0.4)) at RY-RC, FLA-FLC-FLB terminals (Default setting: RY-RC).
  - ★ If the inverter is so set, the signal will be put out through the open collector OUT and NO output terminals (24 Vdc-Max. 50 mA).

[Parameter setting]

Title	Function	Adjustment range	Default setting
<b>F 100</b>	Low-speed signal output frequency	0.0 ~ $F_H$ (Hz)	0.0

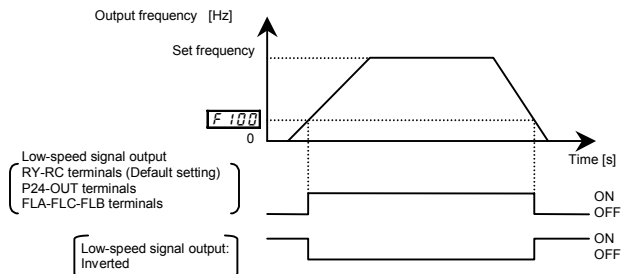

An example of the connection of the open collector OUT terminal

An example of the connection of the relay output terminals

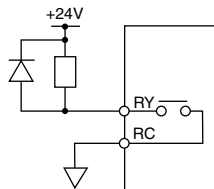
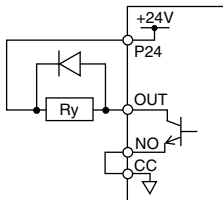

- Output terminal setting  
Output of the low-speed signal (ON signal) between the RY and RC terminals is the factory default setting of the output terminal selection parameter. This setting must be changed to invert the polarity of the signal.

[Parameter setting]

Title	Function	Adjustment range	Default setting
F 130	Output terminal selection 1A (RY-RC)	0-255 (See Section 11, K-18)	4 (ON signal) or 5 (OFF signal)

Set F 131 to output to OUT-NO terminals.

## 6.1.2 Output of designated frequency reach signal

**F 102**: Speed reach detection band

- Function  
When the output frequency becomes equal to the setting by designated frequency  $\pm F 102$ , an ON or OFF signal is generated.

### Parameter setting of designated frequency and detection band

Title	Function	Adjustment range	Default setting
F 102	Speed reach detection band	0.0 ~ F H (Hz)	2.5

### Parameter setting of output terminal selection

Title	Function	Adjustment range	Default setting
F 131	Output terminal selection 2A (OUT-NO)	0-255 (See Section 11, K-18)	6: RCH (designated frequency - ON signal), 7: RCHN (designated frequency - OFF signal)

Note: Select the F 130 parameter to specify RY-RC terminal output, or the F 132 parameter to specify FLA-FLC-FLB terminal output.

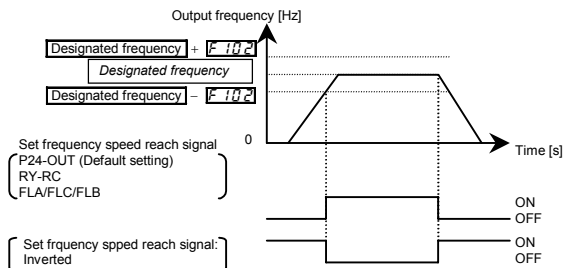

### 6.1.3 Output of set frequency speed reach signal

$F101$ : Speed reach setting frequency

$F102$ : Speed reach detection band

- Function  
When the output frequency becomes equal to the frequency set by  $F101 \pm F102$ , an ON or OFF signal is generated.

#### Parameter setting of frequency and detection band

Title	Function	Adjustment range	Default setting
$F101$	Speed reach setting frequency	0.0 ~ $F_H$ (Hz)	0.0
$F102$	Speed reach detection band	0.0 ~ $F_H$ (Hz)	2.5

#### Parameter setting of output terminal selection

Title	Function	Adjustment range	Default setting
$F131$	Output terminal selection 2A (OUT-NO)	0-255 (See Section 11, K-18)	8: RCHF (designated frequency - ON signal), or 9: RCHFN (designated frequency - OFF signal)

Note: Select the  $F130$  parameter to specify RY-RC terminal output, or set the  $F132$  parameter function No. to 8 or 9 to specify FLA-FLC-FLB terminal output.

If the detection band value + the set frequency is less than the designated frequency

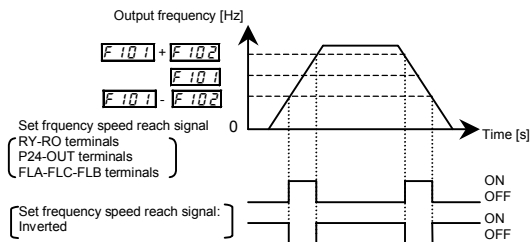

## 6.2 Input signal selection

### 6.2.1 Priority selection (both F-CC, R-CC are ON)

**F105**: Priority selection (both F-CC, R-CC are ON)

- Function  
 This parameter allows you to select the direction in which the motor runs when a forward run (F) command and a reverse run (R) command are entered simultaneously.
  - 1) Reverse
  - 2) Slowdown stop

#### Parameter setting

Title	Function	Adjustment range	Default setting
F105	Priority selection (both F-CC, R-CC are ON)	0: Reverse 1: Slowdown stop	1

[F 105 = 1 (Stop)]: If an F command and an R command are entered simultaneously,  
the motor will slow down to a stop.

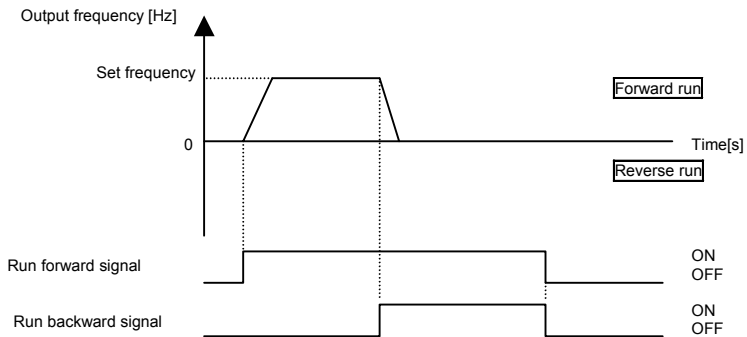

[F 105 = 0 (Reverse)]: If an F command and an R command are entered simultaneously,  
the motor will run in the reverse direction.

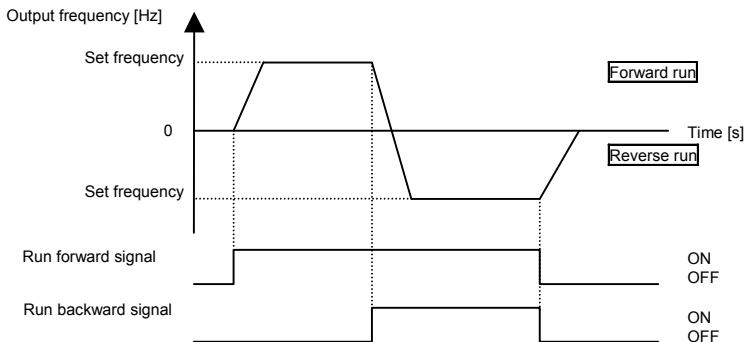

## 6.2.2 Changing the functions of VIA and VIB terminals

**F 109**: VIA/VIB terminal function selection

- **Function**  
This parameter allows you to choose between signal input and contact signal input for the VIA and VIB terminals.

### Parameter setting

Title	Function	Adjustment range	Default setting
<i>F 109</i>	Analog/contact input function selection (VIA/VIB terminal)	0: VIA - analog input VIB - analog input 1: VIA - analog input VIB - contact input (Sink) 2: VIA - analog input VIB - contact input (Source) 3: VIA - contact input (Sink) VIB - contact input (Sink) 4: VIA - contact input (Source) VIB - contact input (Source)	0

- \* When using the VIA and VIB terminals as contact input terminals in sink logic connection, be sure to insert a resistor between the P24 terminal and the VIA/VIB terminals. (Recommended resistance: 4.7kΩ-1/2W)

Note: When using the VIA terminal as a contact input terminal, be sure to turn the VIA slide switch to the V position.

- ☆ The figure on the right shows an example of the connection of input terminals VIA and VIB when they are used as contact input terminals. This example illustrates the connection when the inverter is used in sink logic mode.

- ☆ The figure on the right shows an example of the connection of input terminals VIA and VIB when they are used as contact input terminals. This example illustrates the connection when the inverter is used in sink (Negative) logic mode.

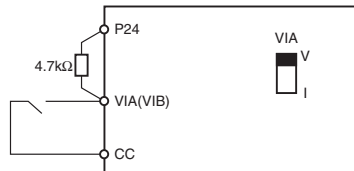

## 6.3 Terminal function selection

### 6.3.1 Keeping an input terminal function always active (ON)

**F108**: Always-active function selection 1

**F110**: Always-active function selection 2

- Function  
This parameter specifies an input terminal function that is always to be kept active (ON).

#### Parameter setting

Title	Function	Adjustment range	Default setting
<b>F108</b>	Always-active function selection 1	0-65 (See K-16)	0 (No function)
<b>F110</b>	Always-active function selection 2	0-65 (See K-16)	1 (Standby)

#### \* Coast stop

The standard default setting is for deceleration stop.

To make a coast stop, assign a "1(ST)" terminal function to an idle terminal using the programmable terminal function.

Change to **F110=0**.

For coast stop, open the ST-CC when stopping the motor in the state described at left. The monitor on the inverter at this time will display **0FF**.

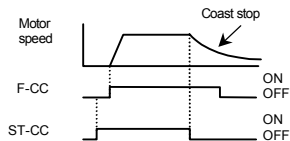

### 6.3.2 Modifying input terminal functions

**F111**: Input terminal selection 1 (F)

**F112**: Input terminal selection 2 (R)

**F113**: Input terminal selection 3 (RES)

**F114**: Input terminal selection 4 (S1)

**F115**: Input terminal selection 5 (S2)

**F116**: Input terminal selection 6 (S3)

**F117**: Input terminal selection 7 (VIB)

**F118**: Input terminal selection 8 (VIA)

- Function  
Use the above parameters to send signals from an external programmable controller to various control input terminals to operate and/or set the inverter.  
The desired contact input terminal functions can be selected from 66 types (0 to 65). This gives system design flexibility. (Note, however, for  $F 117$  and  $F 118$ , a function can be selected from among 13 functions (5 to 17).)

- Note that the setting 52 (forced operation) can be enabled only when the inverter is so configured at the factory. For more information, contact your local Toshiba dealer.
- The functions of the VIB and VIA terminals can be selected between analog input and contact input by changing parameter settings  $F 109$ .  
To use the VIA and VIB terminals as contact input terminals, you need to set  $F 109$  to the number (1 to 4) that suits your needs, since analog input (voltage signal input) is assigned to the terminals by default.

## ■ Setting of contact input terminal function

Terminal symbol	Title	Function	Adjustment range	Default setting
-	$F 108$	Always-active function selection 1	0-65 (See K-16-18)	0
-	$F 110$	Always-active function selection 2		1 (ST)
F	$F 111$	Input terminal selection 1 (F)		2 (F)
R	$F 112$	Input terminal selection 2 (R)		3 (R)
RES	$F 113$	Input terminal selection 3 (RES)		10 (RES)
S1	$F 114$	Input terminal selection 4 (S1)		6 (SS1)
S2	$F 115$	Input terminal selection 5 (S2)		7 (SS2)
S3	$F 116$	Input terminal selection 6 (S3)		8 (SS3)
VIB	$F 117$	Input terminal selection 7 (VIB)	5-17 (Note 2)	9 (SS4)
VIA	$F 118$	Input terminal selection 8 (VIA)		5 (AD2)

Note 1. The function that has been selected using  $F 108$  and  $F 110$  (always-active function selection parameter) are always activated.

Note 2. When using the VIA and VIB terminals as contact input terminals in sink logic connection, be sure to insert a resistor between the P24 terminal and the VIA/VIB terminals. (Recommended resistance: 4.7k $\Omega$ -1/2W)

Be sure to turn the VIA slide switch to the V position.

Note 3.  $F 117$  (VIB): Enabled only when  $F 109 = 1$  to 4  
Disabled and the set value cannot be read out, if  $F 109$  is set at 0.

Note 4.  $F 118$  (VIA): Enabled only when  $F 109 = 3$  or 4  
Disabled and the set value cannot be read out, if  $F 109$  is set at 0 to 2.

## ■ Connection method

### 1) A-contact input

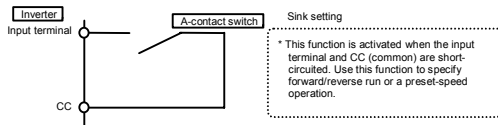

### 2) Connection with transistor output

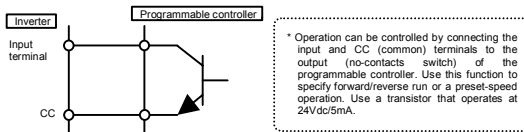

\* Interface between programmable controller and inverter

Note 1: When using a programmable controller with open collector outputs for control, connect it to the PCL terminal, as shown in the figure below, to prevent the inverter from malfunctioning because of a current that flows in.

**Also, be sure to turn the SW1 slide switch to the PLC position.**

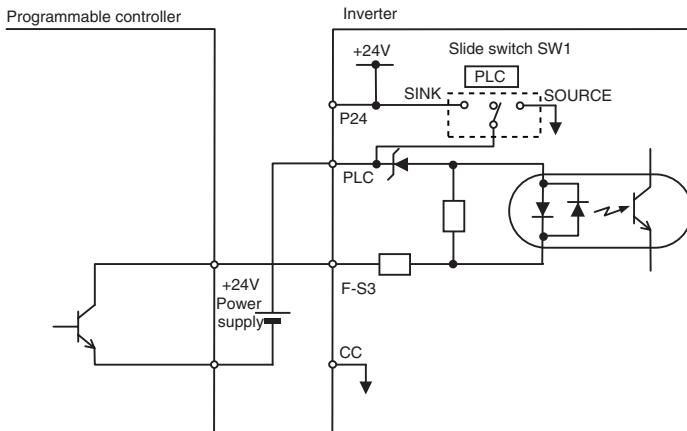

### 3) Sink logic/source logic input

Sink logic/source logic (input/output terminal logic) switching is possible.

For more details, see 2.3.2.

## 6.3.3 Modifying output terminal functions

**F130**: Output terminal selection 1A (RY-RC)

**F131**: Output terminal selection 2A (OUT-NO)

**F132**: Output terminal selection 3 (FLA, FLB, FLC)

- Function

Use the above parameters to send various signals from the inverter to external equipment.

By setting parameters for the RY-RC, OUT-NO and FL (FLA, FLB and FLC) terminals on the terminal board, you can use 58 functions and functions obtained by combining them.

To assign only one function to output terminals, assign the function to *F130* and *F131* while leaving *F132* to *F139* as they are set by default.

6

### Examples of application

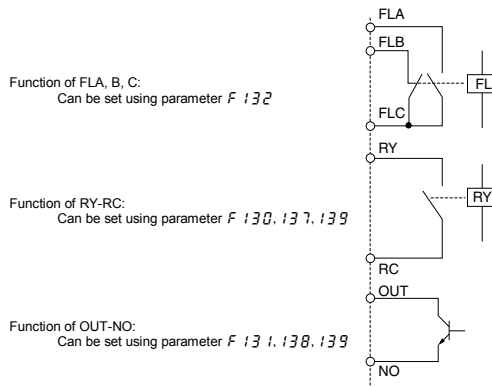

### ■ Assigning one function to an output terminal

Terminal symbol	Title	Function	Adjustment range	Default setting
RY - RC	<i>F 130</i>	Output terminal selection 1A	0-255 (See section 11.)	4 (Low-speed detection signal)
OUT - NO	<i>F 131</i>	Output terminal selection 2A		6 (Designated frequency reach)
FL (A, B, C)	<i>F 132</i>	Output terminal selection 3		10(Failure FL)

- ☆ When assigning one function to each output terminal, set parameters *F 130* to *F 132* only. Do not change but leave parameters *F 137* to *F 139* as they were set by default.  
(Standard default setting: *F 137*=255, *F 138*=255, *F 139*=0)

## 6.3.4 Assigning two functions to an output terminal

***F 130***: Output terminal selection 1A (RY-RC)

***F 131***: Output terminal selection 2A (OUT-NO)

***F 137***: Output terminal selection 1B (RY-RC)

***F 138***: Output terminal selection 2B (OUT-NO)

***F 139***: Output terminal logic selection (RY-RC, OUT-NO)

- Function  
2 different functions can be assigned to the terminal board output terminals RY-RC and OUT-NO. Signals of 2 functions of the logical product (AND) or logical sum (OR) selected from 58 functions can be output to 1 output terminal.

Note. *F 138* (OUT-NO): Enabled only when *F 669*=0.

Disabled and the set value cannot be read out, if *F 669* is set at 1.

(1) A signal is sent out when the two functions assigned are activated simultaneously.

Terminal symbol	Title	Function	Adjustment range	Default setting
RY-RC	$F 130$	Output terminal selection 1A	0-255 (See section 11.)	4 (Low-speed detection signal)
OUT-NO	$F 131$	Output terminal selection 2A		6 (Designated frequency reach)
RY-RC	$F 137$	Output terminal selection 1B		255 (Always ON)
OUT-NO	$F 138$	Output terminal selection 2B		

- ★ Two different functions can be assigned to terminals RY-RC and terminals OUT-NO.
- ★ If parameter  $F 139$  is set to 0 (default), a signal will be sent out when the two functions assigned are activated simultaneously.  
 Terminals RY-RC: Send out a signal when the functions assigned with  $F 130$  and  $F 137$  are activated simultaneously.  
 Terminals OUT-NO: Send out a signal when the functions assigned with  $F 131$  and  $F 138$  are activated simultaneously.

★ Timing chart

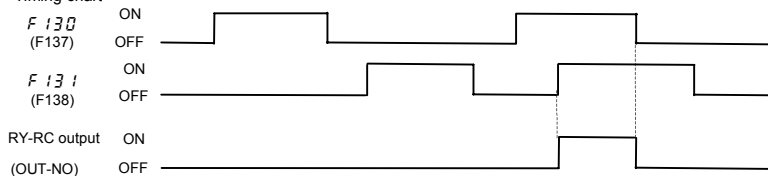

- ★ Only one function can be assigned to terminals FLA-FLB-FLC at a time.

(2) A signal is sent out when either of the two functions assigned is activated.

Terminal symbol	Title	Function	Adjustment range	Default setting
RY - RC	<i>F 130</i>	Output terminal selection 1A	0~255 (See section 11.)	4 (Low-speed detection signal)
OUT - NO	<i>F 131</i>	Output terminal selection 2A		6 (Designated frequency reach)
RY - RC	<i>F 137</i>	Output terminal selection 1B		255 (Always ON)
OUT - NO	<i>F 138</i>	Output terminal selection 2B		255 (Always ON)
RY - RC/ OUT - NO	<i>F 139</i>	Output terminal logic selection	0: <i>F 130</i> and <i>F 137</i> <i>F 131</i> and <i>F 138</i> 1: <i>F 130</i> or <i>F 137</i> <i>F 131</i> and <i>F 138</i> 2: <i>F 130</i> and <i>F 137</i> <i>F 131</i> or <i>F 138</i> 3: <i>F 130</i> or <i>F 137</i> <i>F 131</i> or <i>F 138</i>	0

- ★ Two different functions can be assigned to terminals RY-RC and terminals OUT-NO.
- ★ If parameter *F 139* is set to 3, a signal will be sent out when either of the two functions assigned is activated.  
 Terminals RY-RC: Send out a signal when either of the functions set with *F 130* and *F 137* is activated.  
 Terminals OUT-NO: Send out a signal when either of the functions set with *F 131* and *F 138* is activated.
- ★ Timing chart

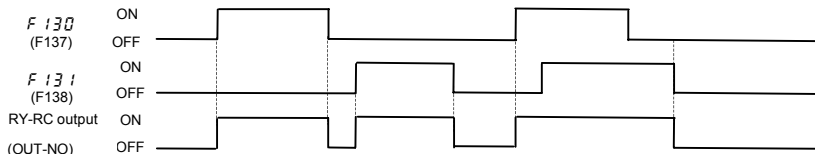

- ★ Only one function can be assigned to terminals FLA-FLB-FLC at a time.

- (3) The logical product (AND) or logical sum (OR) of the two functions assigned is put out as a signal.

■ Setting of output terminal function

Terminal symbol	Title	Function	Adjustment range	Default setting
RY-RC	$F 130$	Output terminal selection 1A	0-255 (See Section 11)	4 (Low-speed detection signal)
OUT-NO	$F 131$	Output terminal selection 2A		6 (Designated frequency reach)
FL (A,B,C)	$F 132$	Output terminal selection 3		10 (Failure FL)
RY-RC	$F 137$	Output terminal selection 1B		255 (Always active)
OUT-NO	$F 138$	Output terminal selection 2B		255 (Always active)
RY-RC/ OUT-NO	$F 139$	Output terminal logic selection	0: $F 130$ and $F 137$ $F 131$ and $F 138$ 1: $F 130$ or $F 137$ $F 131$ and $F 138$ 2: $F 130$ and $F 137$ $F 131$ or $F 138$ 3: $F 130$ or $F 137$ $F 131$ or $F 138$	0

Two different functions can be assigned to the output terminals (RY-RC and OUT-NO), and two logics with different functions can be selected using  $F 139$ .

The logical product (AND) or logical sum (OR) of the two functions assigned is put out as a signal, depending on the setting of parameter  $F 139$ .

If  $F 139 = 0$ , the logical sum (AND) of  $F 130$  and  $F 137$  will be output to RY-RC.

The logical product (OR) of  $F 131$  and  $F 138$  will be output to OUT-NO.

If  $F 139 = 1$ , the logical product (OR) of  $F 130$  and  $F 137$  will be output to RY-RC.

The logical sum (AND) of  $F 131$  and  $F 138$  will be output to OUT-NO.

If  $F 139 = 2$ , the logical sum (AND) of  $F 130$  and  $F 137$  will be output to RY-RC.

The logical product (OR) of  $F 131$  and  $F 138$  will be output to OUT-NO.

If  $F 139 = 3$ , the logical product (OR) of  $F 130$  and  $F 137$  will be output to RY-RC.

The logical product (OR) of  $F 131$  and  $F 138$  will be output to OUT-NO.

- ★ To assign only one function to output terminals, assign the function to  $F 130$  and  $F 131$  while leaving  $F 137$  to  $F 139$  as they are set by default.

Note:  $F 138$  (OUT-NO): Enable only when  $F 669=0$

Disabled and the set value cannot be read out, if  $F 669$  is set to 1.

(4) Holding the output of signals in ON status

- ★ If the conditions for activating the functions assigned to output terminals RY-RC and OUT-NO agree with and as a result the output of signals is put in ON status, the output of signals is held ON, even if the conditions change. (Output terminal holding function)
- ★ Assign input terminal function 62 or 63 to a contact input terminal available.

## Input terminal function

Function No.	Code	Function	Action
62	HRDRY	Holding of RY-RC terminal output	ON: Once turned on, RY-RC are held on. OFF: The status of RY-RC changes in real time according to conditions.
63	HDOUT	Holding of OUT-NO terminal output	ON: Once turned on, OUT-NO are held on. OFF: The status of OUT-NO changes in real time according to conditions.

- ☆ Once output terminal RY-RC or OUT-NO is turned on when the contact input terminal to which one of the above functions (function 62 or 63) is assigned is ON, output terminal RY-RC or OUT-NO is held ON.

## 6.3.5 Comparing the frequency command values

**F167**: Frequency command agreement detection range

**FADd**: Frequency setting mode selection 1

**F207**: Frequency setting mode selection 2

- Function

If the frequency command value specified using **FADd** (or **F207**) almost agrees with the frequency command value from the VA terminal with an accuracy of  $\pm$  the setting of **F167**, an ON or OFF signal will be sent out.

## Frequency command value and agreement detection range parameter setting

Title	Function	Adjustment range	Default setting
<b>F167</b>	Frequency command agreement detection range	0.0 ~ $F_H$ (Hz)	2.5
<b>FADd</b>	Frequency setting mode selection 1	0-6 (See Section 11, K-1,	0
<b>F207</b>	Frequency setting mode selection 2	5)	1

Note: To put out signals to RY-RC, OUT or FLA-FLB-FLC, set **F130**, **F131**, or **F132** respectively to 52 or 53.

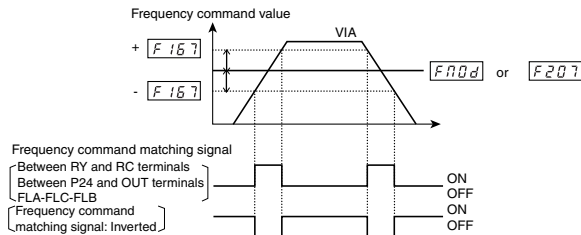

Note: This function can be used, for example, to send out a signal indicating whether the amount of processing and the amount of feedback agree with each other when the PID function is in use. For an explanation of the PID function, see 6.16.

## 6.4 Basic parameters 2

### 6.4.1 Switching motor characteristics via terminal input

**F170**: Base frequency 2

**F171**: Base frequency voltage 2

**F172**: Torque boost 2

**F173**: Motor electronic-thermal protection level 2

**F185**: Stall prevention level 2

- Function

Use the above parameters to switch the operation of two motors with a single inverter and to select motor V/F characteristics (two types) according to the particular needs or operation mode.

Note: The  $P\bar{L}$  (V/F control mode selection) parameter is enabled only for motor1.

If motor 2 is selected, V/F control will be given constant torque characteristics.

#### Parameter setting

Title	Function	Adjustment range	Default setting
<b>F170</b>	Base frequency 2	25.0-500.0 (Hz)	50.0 (WP type) 60.0 (WN, AN type)
<b>F171</b>	Base frequency voltage 2	50-330 (V) : 240V class 50-660 (V) : 500 / 600V class	230 (240V class) 460 (500V class) 575 (600V class)
<b>F172</b>	Torque boost 2	0.0-30.0 (%)	Depending on model (See Section 11, K-15)
<b>F173</b>	Motor electronic-thermal protection level 2	10-100 (%) / (A)	100
<b>F185</b>	Stall prevention level 2	10-199 (%) / (A), 200 : Disabled	150

## ■ Setting of switching terminals

The terminal for switching to motor 2 needs to be set, since this function is not assigned under the default setting. Assign this function to an idle terminal.

The parameters to be switched depend on the particular identification number of the input terminal selection function.

Input terminal function number					Parameters used and applicable parameters
5 AD2	39 VF2	40 MOT2	58 AD3	61 OCS2	
OFF	OFF	OFF	OFF	OFF	Default setting: <i>Pt, uL, uLv, ub, tHr, ACC, dEC, F502, F601</i>
ON	OFF	OFF	OFF	OFF	<i>ACC → F500, dEC → F501, F502 → F503</i>
-	OFF	OFF	ON	OFF	<i>ACC → F510, dEC → F511, F502 → F512</i>
OFF	OFF	OFF	OFF	ON	<i>F601 → F185</i>
OFF	ON	OFF	OFF	OFF	<i>Pt → 0, uL → F170, uLv → F171, ub → F172, tHr → F173</i>
-	-	ON	OFF	-	<i>Pt → 0, uL → F170, uLv → F171, ub → F172, tHr → F173, F601 → F185, ACC → F500, dEC → F501, F502 → F503</i>

Note. The parameters *uL, uLv, Pt, F170* and *F171* cannot be switched during operation. You need to stop operation when switching them.

## 6.5 Frequency priority selection

### 6.5.1 Using a frequency command according to the particular situation

**F00d**: Frequency setting mode selection 1

**F200**: Frequency priority selection

**F207**: Speed setting mode selection 2

- Function

These parameters are used to switch between two types of frequency command signals.

- Setting by parameters
- Switching by frequency
- Switching via terminal board input

## Parameter setting

Title	Function	Adjustment range	Default setting
<i>FNDd</i>	Frequency setting mode selection 1	0: Built-in potentiometer 1: VIA 2: VIB 3: Operation panel 4: Serial communication 5: UP/DOWN from external contact 6: VIA + VIB (Override)	0
<i>F200</i>	Frequency priority selection	0: <i>FNDd</i> (Switchable to <i>F207</i> by the input terminal) 1: <i>FNDd</i> ( <i>F207</i> for output frequencies equal to or lower than 1.0 Hz)	0
<i>F207</i>	Frequency setting mode selection 2	0: Built-in potentiometer 1: VIA 2: VIB 3: Operation panel 4: Serial communication 5: UP/DOWN from external contact 6: VIA + VIB (Override)	1

### 1) External switching (Input terminal function 38 : FCHG enabled)

Frequency priority selection parameter *F200* = 0

Switching between the command specified with *FNDd* and *F207* can be made by entering a command from a terminal board.

To do so, however, the frequency command forced switching function (input terminal function selection: 38) needs to be set beforehand to an input terminal board.

If an OFF command is entered to the input terminal board: The command specified with *FNDd* will be selected.

If an ON command is entered to the input terminal board: The command specified with *F207* will be selected.

### 2) Automatic switching by frequency command

Frequency priority selection parameter *F200* = 1

The switching between the command specified with *FNDd* and *F207* is done automatically according to the frequency command entered.

If the frequency set with *FNDd* is above 1Hz: The command specified with *FNDd* will be selected.

If the frequency set with *FNDd* is 1Hz or less: The command specified with *F207* will be selected.

## 6.5.2 Setting frequency command characteristics

**F201**: VIA input point 1 setting

**F202**: VIA input point 1 frequency

**F203**: VIA input point 2 setting

**F204**: VIA input point 2 frequency

**F210**: VIB input point 1 setting

**F211**: VIB input point 1 frequency

**F212**: VIB input point 2 setting

**F213**: VIB input point 2 frequency

**F811**: Communication command point 1 setting

**F812**: Communication command point 1 frequency

**F813**: Communication command point 2 setting

**F814**: Communication command point 2 frequency

- Function

These parameters adjust the output frequency according to the externally applied analog signal (0-10Vdc voltage, 4-20mAdc current) and the entered command for setting an external contact frequency.

- ★ To fine adjust the frequency command characteristics for VIA/VIB input, use the parameters **F470** to **F473**. (See section 6.5.4.)

## Parameter setting

Title	Function	Adjustment range	Default setting
$F201$	VIA input point 1 setting	0-100 (%)	0
$F202$	VIA input point 1 frequency	0.0-500.0 (Hz)	0.0
$F203$	VIA input point 2 setting	0-100 (%)	100
$F204$	VIA input point 2 frequency	0.0-500.0 (Hz)	50.0 (WP type) 60.0 (WN, AN type)
$F210$	VIB input point 1 setting	0-100 (%)	0
$F211$	VIB input point 1 frequency	0.0-500.0 (Hz)	0.0
$F212$	VIB input point 2 setting	0-100 (%)	100
$F213$	VIB input point 2 frequency	0.0-500.0 (Hz)	50.0 (WP type) 60.0 (WN, AN type)
$FB11$	Communication command point 1 setting	0-100 (%)	0
$FB12$	Communication command point 1 frequency	0.0-500.0 (Hz)	0.0
$FB13$	Communication command point 2 setting	0-100 (%)	100
$FB14$	Communication command point 2 frequency	0.0-500.0 (Hz)	60.0

Note 1: Don't set the same value between point 1 and point 2. If set the same value, the  $Err$  is displayed.

### 1) 0-10Vdc voltage input adjustment (VIA, VIB)

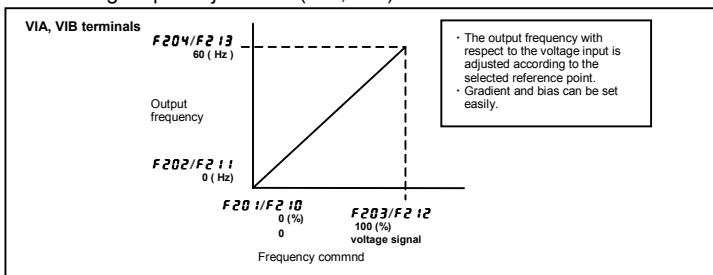

### 2) 4-20mA current input adjustment (VIA: VIA slide switch in the I position)

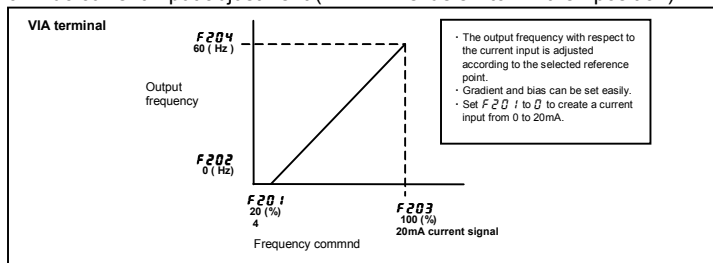

### 6.5.3 Setting of frequency with the input from an external contact

**F264**: External contact input - UP response time

**F265**: External contact input - UP frequency steps

**F266**: External contact input - DOWN response time

**F267**: External contact input - DOWN frequency steps

**F268**: Initial up/down frequency

**F269**: Change of the initial up/down frequency

- Function

These parameters are used to set an output frequency by means of a signal from an external device.

Title	Function	Adjustment range	Default setting
F264	External contact input - UP response time	0.0 - 10.0 (S)	0.1
F265	External contact input - UP frequency steps	0.0 - FH (Hz)	0.1
F266	External contact input - DOWN response time	0.0 - 10.0 (S)	0.1
F267	External contact input - DOWN frequency steps	0.0 - FH (Hz)	0.1
F268	Initial up/down frequency	LL - UL (Hz)	0.0
F269	Change of the initial up/down frequency	0: Not changed 1: Setting of F268 changed when power is turned off	1

\* These functions take effect when parameter *F70d* (frequency setting mode selection 1) is set to 5 or parameter *F207* (frequency setting mode selection 2) is set to 5 is enabled.

#### ■ Adjustment with continuous signals (Parameter-setting example 1)

Set parameters as follows to adjust the output frequency up or down in proportion to the frequency adjustment signal input time:

Panel frequency incremental gradient =  $F265 / F264$  setting time

Panel frequency decremental gradient =  $F267 / F266$  setting time

Set parameters as follows to adjust the output frequency up or down almost in synchronization with the adjustment by the panel frequency command:

$F264 = F266 = 1$

$(FHRL) \geq (F265 / F264 \text{ setting time})$

$(FHdE) \geq (F267 / F266 \text{ setting time})$

## &lt;&lt;Sample sequence diagram 1: Adjustment with continuous signals&gt;&gt;

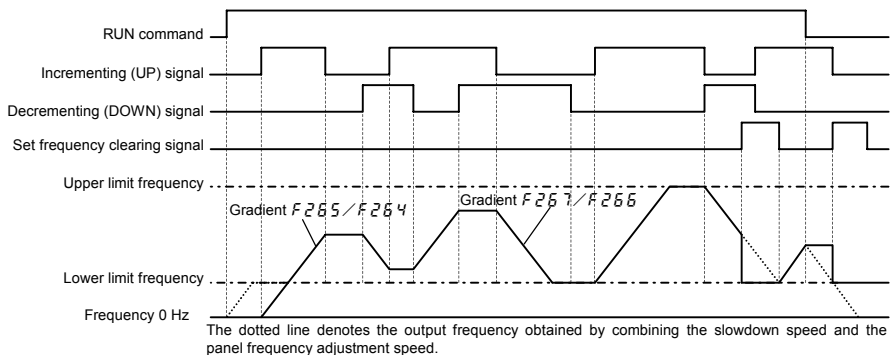

Note: If the operation frequency is set to the lower limit frequency, it will increase from 0Hz when power is turned on for the first time after the setting, and therefore the output frequency will not rise until the operation frequency reaches the lower limit frequency. (Operation at the lower limit frequency)  
In this case, the time required for the operation frequency to reach the lower limit frequency can be shortened by setting  $f_c$  to the lower limit frequency.

### ■ Adjustment with pulse signals (Parameter-setting example 2)

Set parameters as follows to adjust the frequency in steps of one pulse:

$F264, F266 \leq$  Pulse On time

$F265, F267 =$  Frequency obtained with each pulse

- \* The inverter does not respond to any pulses with an ON time shorter than that set with  $F264$  or  $F266$ . 12ms or more of clearing signal is allowed.

## &lt;&lt;Sample sequence diagram 2: Adjustment with pulse signals&gt;&gt;

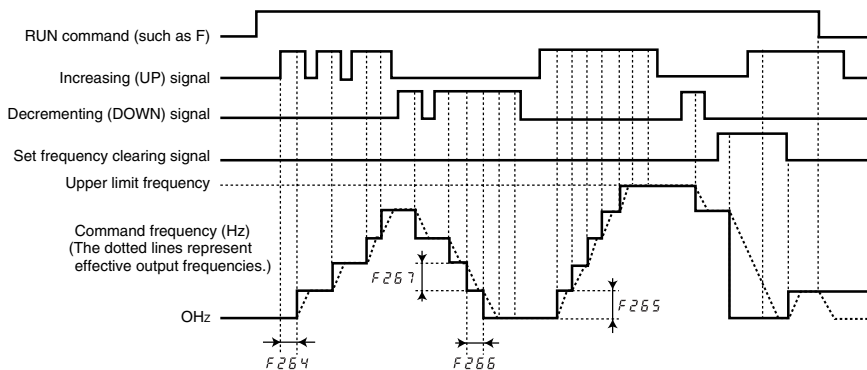

■ If two signals are impressed simultaneously

- If a clear single and an up or down signal are impressed simultaneously, priority will be given to the clear signal.
- If up and down signals are impressed simultaneously, The frequency will change at the specified up or down rate.

■ About the setting of the initial up/down frequency

To adjust the frequency starting at a specified frequency other than 0.0 Hz (default initial frequency) after turning on the inverter, specify the desired frequency using  $F_{257}$  (initial up/down frequency).

■ About the change of the initial up/down frequency

To make the inverter automatically save the frequency immediately before it is turned off and start operation at that frequency next time power is turned on, set  $F_{259}$  (change of initial up/down frequency) to 1 (which changes the setting of  $F_{258}$  when power is turned off). Keep in mind that the setting of  $F_{258}$  is changed each time power is turned off.

■ Frequency adjustment range

The frequency can be set from 0.0Hz to  $F_H$  (Maximum frequency). The lower-limit frequency will be set as soon as the set frequency clearing function (function number 43, 44) is entered from the input terminal.

■ Minimum unit of frequency adjustment

If  $F_{702}$  (Frequency free unit magnification) is set to 1.00, the output frequency can be adjusted in steps of 0.01Hz.

## 6.5.4 Fine adjustment of frequency setting signal

**F470**: VIA input bias

**F471**: VIA input gain

**F472**: VIB input bias

**F473**: VIB input gain

- Function

These parameters are used to fine adjust the relation between the frequency setting signal input through the analog input terminals VIA and VIB and the output frequency.

Use these parameters to make fine adjustments after making rough adjustments using the parameters **F201** to **F213**.

The figure below shows the characteristic of the frequency setting signal input through the VIA and VIB terminals and that of the output frequency.

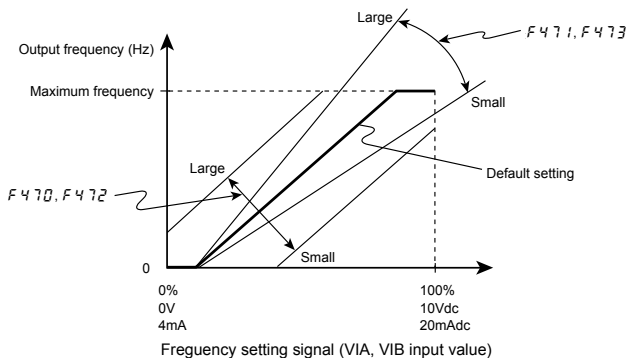

- \* Bias adjustment of VIA and VIB input terminals (**F470** and **F472**)

To give leeway, the inverter is factory-adjusted by default so that it will not produce an output until a certain amount of voltage is applied to the VIA and VIB input terminals. If you want to reduce the leeway, set **F470** or **F472** to a larger value. Note that specifying a too large value may cause an output frequency to be output, even though the operation frequency is 0 (zero) Hz.

- \* Gain adjustment of VIA and VIB input terminals (**F471** and **F473**)

The inverter is factory-adjusted by default so that the operation frequency can reach the maximum frequency, even though the voltage and current to the VIA and VIB input terminals are below the maximum levels. If you want to adjust the inverter so that it will output the maximum frequency at the maximum voltage and current, set **F471** or **F473** to a smaller value. Note that specifying a too small value may cause the operation frequency not to reach the maximum frequency, even though the maximum voltage and current are applied.

## 6.6 Operation frequency

### 6.6.1 Starting frequency

#### $F240$ : Starting frequency setting

- Function  
The frequency set with  $F240$  is put out as soon as operation is started. Use the  $F240$  parameter when a delay in response of starting torque according to the acceleration/deceleration time is probably affecting operation. Setting the starting frequency to a value from 0.5 to 3Hz is recommended. The occurrence of an overcurrent can be suppressed by setting this frequency below the rated slippage of the motor.

#### [Parameter setting]

Title	Function	Adjustment range	Default setting
$F240$	Starting frequency setting	0.5-10.0 (Hz)	0.5

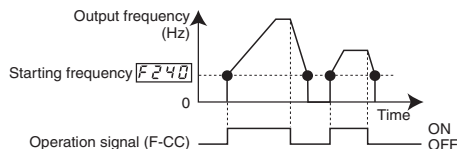

### 6.6.2 Run/stop control with frequency setting signals

#### $F241$ : Operation starting frequency

#### $F242$ : Operation starting frequency hysteresis

- Function  
The Run/stop of operation can be controlled simply with frequency setting signals.

#### [Parameter setting]

Title	Function	Adjustment range	Default setting
$F241$	Operation starting frequency	0.0-FH (Hz)	0.0
$F242$	Operation starting frequency hysteresis	0.0-FH (Hz)	0.0

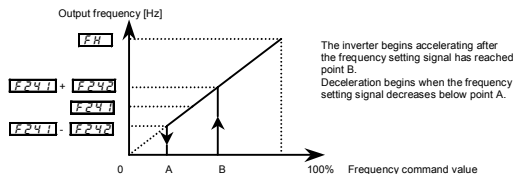

## 6.7 DC braking

### 6.7.1 DC braking

**F250**: DC braking starting frequency

**F251**: DC braking current

**F252**: DC braking time

- Function

A large braking torque can be obtained by applying a direct current to the motor. These parameters set the direct current to be applied to the motor, the application time and the starting frequency.

[Parameter setting]

Title	Function	Adjustment range	Default setting
<b>F250</b>	DC braking starting frequency	0.0- $F_H$ (Hz)	0.0
<b>F251</b>	DC braking current	0.0-100 (%) / (A)	50
<b>F252</b>	DC braking time	0.0- 20.0 (sec)	1.0

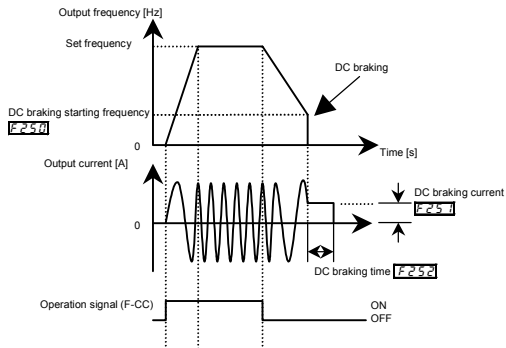

Note1: During DC braking, the overload protection sensitivity of the inverter increases. The DC braking current may be adjusted automatically to prevent tripping.

Note 2: During DC braking, the carrier frequency is 4kHz or less irrespective of the setting of parameter **F300** (PWM carrier frequency).

## 6.7.2 Motor shaft fixing control

### **F254**: Motor shaft fixing control

- Function  
This function is used to prevent the motor from running unexpectedly because its shaft is not restrained or to preheat the motor.

#### [Parameter setting]

Title	Function	Adjustment range	Default setting
<b>F254</b>	Motor shaft fixing control	0: Disabled, 1: Enabled	0

If the motor shaft fixing control **F254** is set to 1, half the braking force set with **F251** (DC braking rate) will be applied to the motor to continue DC braking even after the completion of ordinary DC braking. To stop motor shaft fixing control, turn off the standby command (ST signal).

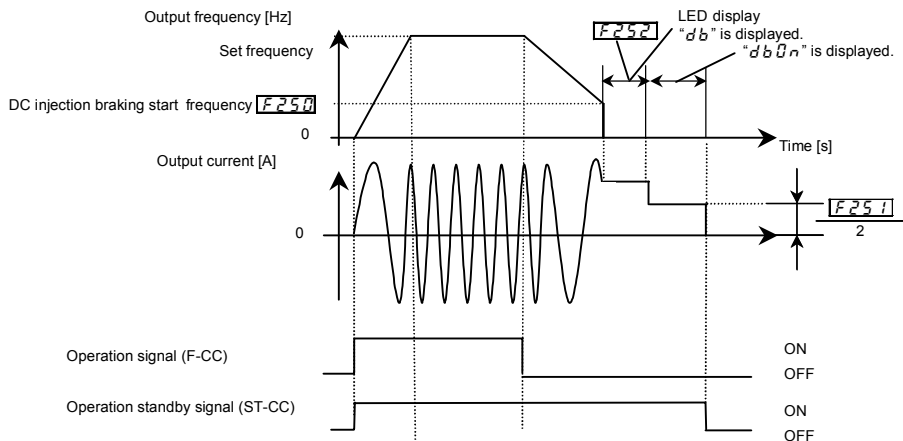

Note1: About the same motor shaft fixing control can be exercised by entering a DC braking command from external contacts.

Note2: If a power failure occurs during motor shaft fixing control and the motor starts to coast, motor shaft fixing control will be canceled.

Also, if the inverter trips during motor shaft fixing control and is restored to working order by the retry function, motor shaft fixing control will be canceled.

Note 3: During shaft fixing control, the carrier frequency is 4kHz or less irrespective of the setting of parameter **F300** (PWM carrier frequency).

## 6.8 Auto-stop in case of lower-limit frequency continuous operation

### 6.8.1 Auto-stop in case of lower-limit frequency continuous operation

**F256**: Auto-stop in case of lower-limit frequency continuous operation

- Function

If operation is carried out continuously at a frequency below the lower-limit frequency ( $L_L$ ) for the period of time set with  $F256$ , the inverter will automatically slow down the motor to a stop. At that time, " $L_L P$ " is displayed (alternately) on the operation panel.

This function will be canceled if a frequency command above the lower-limit frequency ( $L_L$ ) + 0.2Hz.

[Parameter setting]

Title	Function	Adjustment range	Default setting
$F256$	Auto-stop in case of lower-limit frequency continuous operation time	0.0: None 0.1-600.0 (sec.)	0.0

Output frequency [Hz]

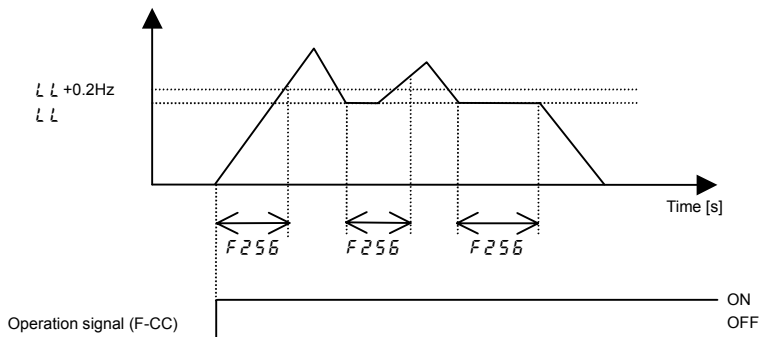

Note: This function is enabled even at the start of operation and during switching between forward and reverse run.

## 6.9 Jog run mode

**F260**: Jog run frequency

**F261**: Jog run stopping pattern

**F262**: Panel jog run mode

- Function  
Use the jog run parameters to operate the motor in jog mode. Input of a jog run signal generates a jog run frequency output at once, irrespective of the designated acceleration time.  
Also, you can choose an operation panel start/stop mode between the ordinary start/stop mode and the jog run start/stop mode.

The jog run function needs to be assigned to an input terminal. When assigning it to the RES terminal, set **F113** to 4.

The motor can be operated in jog mode while the jog run setting terminals are connected (RES-CC ON). (Setting **F113** to 4.)

[Parameter setting]

Title	Function	Adjustment range	Default setting
<b>F260</b>	Jog run frequency	<b>F240</b> -20.0 (Hz)	5.0
<b>F261</b>	Jog run stopping pattern	0: Slowdown stop 1: Coast stop 2: DC braking	0
<b>F262</b>	Panel jog run mode	0: Disabled 1: Panel jog run mode enabled	0

[Setting of jog run setting terminal (RES-CC)]

Assign control terminal RES (4: reset signal) in default setting) as the jog run setting terminal.

Title	Function	Adjustment range	Setting
<b>F113</b>	Input terminal selection (RES)	0-65	4 (jog run setting terminal)

Note 1: During the jog run mode, there is LOW (low speed detection signal) output but no RCH (designated frequency reach signal) output, and PID control does not work.

Note 2: When the operation panel only is used for operation in jog run mode, the jog run function does not need to be assigned to any input terminal.

<Examples of jog run>

RES-CC (JOG) ON + F-CC ON: Forward jog run

RES-CC (JOG) ON + R-CC ON: Reverse jog run

(Normal operation frequency signal input + F-CC ON: Forward run)

(Normal operation frequency signal input + R-CC ON: Reverse run)

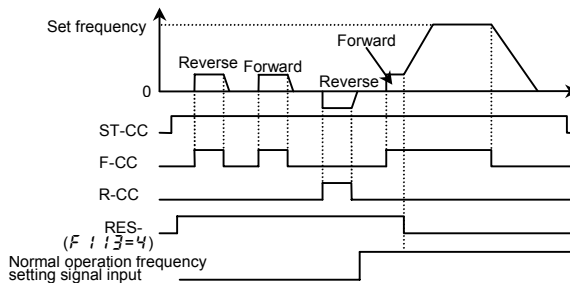

- The jog run setting terminal (RES-CC) is enabled when the operation frequency is below the jog run frequency.
- This connection does not function at an operation frequency exceeding the jog run frequency.
- The motor can be operated in jog mode while the jog run setting terminals are connected (RES-CC).
- Jog run has priority, even when a new operation command is given during operation.
- Even for  $F261 = 0$  or  $1$ , an emergency DC braking becomes enabled when setting  $F603 = 2$ .
- No limits are imposed to the jog run frequency by the upper-limit frequency (parameter  $UL$ ).

#### ■ Panel jog mode (if $F262$ is set to $1$ )

- When the inverter is in panel jog mode, pressing the  $\blacktriangle$  key displays  $F000$ , while pressing the  $\blacktriangledown$  key displays  $r000$ .
- When  $F000$  is displayed, the inverter will be placed in forward jog run mode as long as the  $\text{RUN}$  key is held down.
- When  $r000$  is displayed, the inverter will be placed in reverse jog run mode as long as the  $\text{RUN}$  key is held down.
- During jog run, the direction of rotation can be changed using the  $\blacktriangle$  and  $\blacktriangledown$  keys. Press the  $\blacktriangle$  key to run the motor in the forward direction, or press the  $\blacktriangledown$  key to run it in the reverse direction.
- If you press and hold down the  $\text{RUN}$  key for 20 seconds or more, the key failure alarm "E-17" will be displayed.

Here is the sequence in which modes change each time you press the  $\text{MODE}$  key.

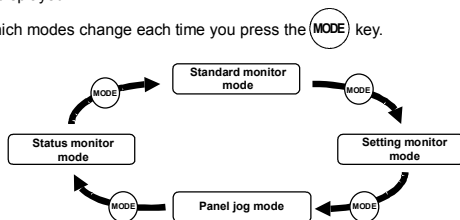

Note: When the inverter is in operation (RUN lamp is blinking) or when an operation command is issued (RUN lamp is lit), the inverter cannot be switched to panel jog mode.

## 6.10 Jump frequency - jumping resonant frequencies

**F270**: Jump frequency 1

**F271**: Jumping width 1

**F272**: Jump frequency 2

**F273**: Jumping width 2

**F274**: Jump frequency 3

**F275**: Jumping width 3

- Function

Resonance due to the natural frequency of the mechanical system can be avoided by jumping the resonant frequency during operation. During jumping, hysteresis characteristics with respect to the jump frequency are given to the motor.

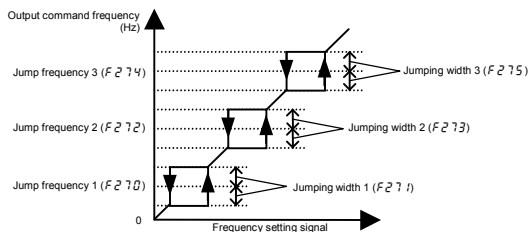

[Parameter setting]

Title	Function	Adjustment range	Default setting
<b>F270</b>	Jump frequency 1	0.0- $F_H$ (Hz)	0.0
<b>F271</b>	Jumping width 1	0.0-30.0 (Hz)	0.0
<b>F272</b>	Jump frequency 2	0.0- $F_H$ (Hz)	0.0
<b>F273</b>	Jumping width 2	0.0-30.0 (Hz)	0.0
<b>F274</b>	Jump frequency 3	0.0- $F_H$ (Hz)	0.0
<b>F275</b>	Jumping width 3	0.0-30.0 (Hz)	0.0

☆ Do not set the jump parameters, if multiple jump frequency setting width overlap.

☆ During acceleration or deceleration, the jumping function is disabled for the operation frequency.

## 6.11 Preset-speed operation frequencies

### 6.11.1 Preset-speed operation frequency 8 to 15

**F287** - **F294**: Preset-speed operation frequency 8 to 15

See Section 5.14 for details.

### 6.11.2 Fire-speed control

**F294**: Preset-speed operation frequency 15 (fire-speed)

- Function  
Fire-speed control is used when operating the motor at the specified frequency in case of an emergency. If fire-speed control is assigned to the terminal board selection parameter and a fire-speed control signal is given, the motor will be operated at the frequency specified with **F294** (preset-speed operation frequency 15). (When the terminal board selection parameter is set to 52 or 53).

6

## 6.12 PWM carrier frequency

**F300**: PWM carrier frequency

**F312**: Random mode

**F316**: Carrier frequency control mode selection

- Function
  - 1) The **F300** parameter allows the tone of the magnetic noise from the motor to be changed by switching the PWM carrier frequency. This parameter is also effective in preventing the motor from resonating with its load machine or its fan cover.
  - 2) In addition, the **F300** parameter reduces the electromagnetic noise generated by the inverter. Reduce the carrier frequency to reduce electromagnetic noise. Note: Although the electromagnetic noise level is reduced, the acoustic noise of the motor is increased.
  - 3) The random mode reduces motor electromagnetic noise by changing the pattern of the reduced carrier frequency.

Note: If you are using 600V models by over 40m cable, the carrier frequency (**F300**) should be set preferably below 4kHz.

## [Parameter setting]

Title	Function	Adjustment range	Default setting
F300	PWM carrier frequency	2.0-16.0 (kHz) (*)	12.0
F312	Random mode	0: Disabled, 1: Enabled	0
F316	Carrier frequency control mode selection	0: Carrier frequency not reduced automatically 1: Carrier frequency reduced automatically 2: Carrier frequency not reduced automatically Support for 500V/600V models 3: Carrier frequency reduced automatically Support for 500V/600V models.	1

- \* Reduction of rated current will be required if the PWM carrier frequency is modified for each applicable motor model. Refer to the following table.
- \* When the PWM carrier frequency is set high, selecting "Carrier frequency not reduced automatically" causes the inverter to be tripped more easily than selecting "Carrier frequency reduced automatically."

## Reduction of rated current.

## [240V Class]

VFS11S- VFS11-	Carrier frequency		
	4kHz or less	12kHz or less	16kHz or less
2002PL/M	1.5A	1.5A	1.5A
2004PL/M	3.3A	3.3A	3.3A
2005PM	3.7A	3.3A	3.3A
2007PL/M	4.8A	4.4A	4.2A
2015PL/M	8.0A	7.9A	7.1A
2022PL/M	11.0A	10.0A	9.1A
2037PM	17.5A	16.4A	14.6A
2055PM	27.5A	25.0A	25.0A
2075PM	33.0A	33.0A	29.8A
2110PM	54.0A	49.0A	49.0A
2150PM	66.0A	60.0A	54.0A

## [500V Class]

Input voltage	480V or less			more than 480V		
	Carrier frequency			Carrier frequency		
	4kHz or less	12 kHz or less	16kHz or less	4kHz or less	12kHz or less	16kHz or less
VFS11- 4004PL	1.5A	1.5A	1.5A	1.5A	1.5A	1.2A
4007PL	2.3A	2.1A	2.1A	2.1A	1.9A	1.9A
4015PL	4.1A	3.7A	3.3A	3.8A	3.4A	3.1A
4022PL	5.5A	5.0A	4.5A	5.1A	4.6A	4.2A
4037PL	9.5A	8.6A	7.5A	8.7A	7.9A	6.9A
4055PL	14.3A	13.0A	13.0A	13.2A	12.0A	12.0A
4075PL	17.0A	17.0A	14.8A	15.6A	14.2A	12.4A
4110PL	27.7A	25.0A	25.0A	25.5A	23.0A	23.0A
4150PL	33.0A	30.0A	26.0A	30.4A	27.6A	24.0A

[600V Class]



VFS11-	Carrier frequency		
	4kHz or less	12kHz or less	16kHz or less
6007P	1.7	1.5	1.4
6015P	2.7	2.4	2.2
6022P	3.9	3.5	3.1
6037P	6.1	5.5	4.9
6055P	9	8.1	7.2
6075P	11	9.9	8.8
6110P	17	15.3	13.6
6150P	22	19.8	17.6

- \* The currents in the above table are used as the basis to make calculations for inverter overload trip ( $\underline{G} L \ i$ ).
- \* Default setting of PWM carrier frequency is 12kHz, but rated output current of rating label display at 4kHz. If  $F \ 3 \ 1 \ 5$  is set to  $1$  or  $3$ , however, the carrier frequency will decrease automatically with increase in current in order to secure the rated current at frequencies of 4 kHz or less.
- \* If  $F \ 3 \ 1 \ 5$  is set to  $0$  or  $2$ ,  $\underline{G} \underline{L} \ P$  trip will occur when the current increases and reaches the level above which the carrier frequency is decreased automatically.
- \* Random control is exercised when the motor is operated in a low-frequency range where it produces annoying magnetic noise. If the carrier frequency ( $F \ 3 \ 0 \ 0$ ) is set above 7.1 kHz, the random control function will not be performed, because the level of motor magnetic noise is low at high frequencies.
- \* When the carrier frequency control mode selection ( $F \ 3 \ 1 \ 5$ ) is set to  $2$  or  $3$ , the carrier frequency ( $F \ 3 \ 0 \ 0$ ) should be set preferably below 4 kHz. Otherwise the output voltage may drop.

## 6.13 Trip-less intensification

### 6.13.1 Auto-restart (Restart of coasting motor)

**F 3 0 1**: Auto-restart control selection

 <b>Caution</b>	
 Mandatory	<ul style="list-style-type: none"> <li>Stand clear of motors and mechanical equipment If the motor stops due to a momentary power failure, the equipment will start suddenly when power is restored. This could result in unexpected injury.</li> <li>Attach warnings about sudden restart after a momentary power failure on inverters, motors and equipment for prevention of accidents in advance.</li> </ul>

- Function  
The  $F \ 3 \ 0 \ 1$  parameter detects the rotating speed and rotational direction of the motor during coasting in the event of momentary power failure, and then after power has been restored, restarts the motor smoothly (motor speed search function). This parameter also allows commercial power operation to be switched to inverter operation without stopping the motor.  
During operation, "r t r 4" is displayed.

Title	Function	Adjustment range	Default setting
<i>F301</i>	Auto-restart control selection	0: Disabled 1: At auto-restart after momentary stop 2: When turning ST-CC on or off 3: At auto-restart or when turning ST-CC on or off 4: At start-up	0

\* If the motor is restarted in retry mode, this function will operate, regardless of the setting of this parameter.

### 1) Auto-restart after momentary power failure (Auto-restart function)

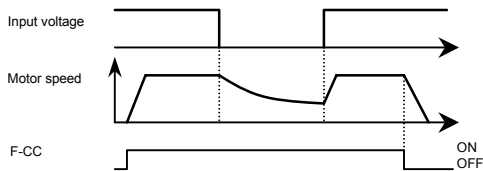

★ Setting *F301* to 1, (3): This function operates after power has been restored following detection of an undervoltage by the main circuits and control power.

### 2) Restarting motor during coasting (Motor speed search function)

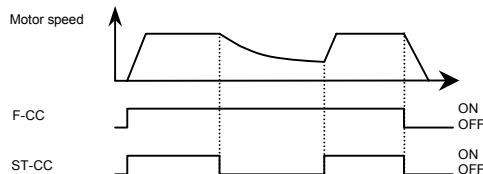

★ Setting *F301* to 2 or 3: This function operates after the ST-CC terminal connection has been opened first and then connected again.

Note: The terminal function ST needs to be assigned to an input terminal, using the parameters *F111* to *F118*.

### 3) DC braking during restart

When  $F3Q1$  is set to 4, a motor speed search is performed each time operation is started.

This function is useful especially when the motor is not operated by the inverter but it is running because of external force.

#### Warning!!

- At restart, it takes about 300 ms for the inverter to check to see the number of revolutions of the motor.  
For this reason, the start-up takes more time than usual.
- Use this function when operating a system with one motor connected to one inverter.  
This function may not operate properly in a system configuration with multiple motors connected to one inverter.

#### **Application to a crane or hoist**

**The crane or hoist may have its load moved downward during the above waiting time from input of the operation starting command to the restart of the motor. To apply the inverter to such machines, therefore, set the auto-restart control mode selection parameter to " $F3Q1=0$ " (Disabled), Do not use the retry function, either.**

6

## 6.13.2 Regenerative power ride-through control/Deceleration stop

**$F3Q2$** : Regenerative power ride-through control/Deceleration stop

- Function
  - Regenerative power ride-through control continues the operation of the motor by utilizing motor regenerative energy in the event of momentary power failure.
  - Slowdown stop in the event of momentary power failure: If a momentary power failure occurs during operation, the inverter stops forcibly. (Deceleration time varies with control.) When operation is stopped, the message " $SLEP$ " is displayed (alternately) on the operation panel. After the forced stop, the inverter remains static until you put off the operation command momentarily.

[Parameter setting]

Title	Function	Adjustment range	Default setting
$F3Q2$	Regenerative power ride-through control / Deceleration stop	0: Disabled 1: Enabled 2: Slowdown stop	0

Note: Even when this parameter is set, the particular load conditions may cause the motor to coast. In this case, use the auto-restart function  $F3Q1$  along with this parameter function.

[When power is interrupted]

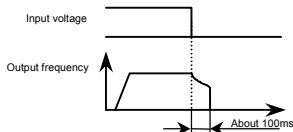

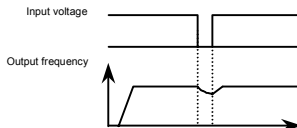

\* The time for which the operation of the motor can be continued depends on the machine inertia and load conditions. Before using this function, therefore, perform verification tests.

[If momentary power failure occurs]



### 6.13.3 Retry function

**F303**: Retry selection (Selecting the number of times)

 Caution	
 Mandatory	<ul style="list-style-type: none"> <li>Do not go near the motor in alarm-stop status when the retry function is selected. The motor may suddenly restart, which could result in injury.</li> <li>Take measures for safety, e.g. attach a cover to the motor, to prevent accidents if the motor suddenly restarts.</li> </ul>

- Function  
This parameter resets the inverter automatically when the inverter gives an alarm. During the retry mode, the motor speed search function operated automatically as required and thus allows smooth motor restarting.

[Parameter setting]

Title	Function	Adjustment range	Default setting
<b>F303</b>	Retry selection (number of times)	0: None, 1-10 times	0

The likely causes of tripping and the corresponding retry processes are listed below.

Cause of tripping	Retry process	Canceling conditions
Momentary power failure	Up to 10 times in succession	The retry function will be canceled at once if tripping is caused by an unusual event other than: momentary power failure, overcurrent, overvoltage or overload. This function will also be canceled if retrying is not successful within the specified number of times.
Overcurrent	1st retry: About 1 sec after tripping	
Overvoltage	2nd retry: About 2 sec after tripping	
Overload	3rd retry: About 3 sec after tripping	
Overheating	10th retry: About 10 sec after tripping	

★ The retry function is disabled in the following unusual events:

- $\overline{O C R}$  : Arm overcurrent at start-up
- $\overline{O C L}$  : Overcurrent on the load side at start-up
- $\overline{E P H 0}$  : Output phase failure
- $\overline{O H 2}$  : External thermal trip
- $\overline{O t}$  : Overtorque trip
- $\overline{E}$  : External trip stop
- $\overline{U C}$  : Small-current operation trip
- $\overline{U P 1}$  : Undervoltage trip (main circuit)
- $\overline{E F 2}$  : Ground fault trip
- $\overline{E P H 1}$  : Input phase failure
- $\overline{E t Y P}$  : Inverter type error
- $\overline{E r r 2}$  : Main unit RAM fault
- $\overline{E r r 3}$  : Main unit ROM fault
- $\overline{E r r 4}$  : CPU fault trip
- $\overline{E r r 5}$  : Remote control error
- $\overline{E r r 7}$  : Current detector fault
- $\overline{E r r 8}$  : Control circuit board format error
- $\overline{E E P 1}$  : EEPROM fault 1
- $\overline{E E P 2}$  : EEPROM fault 2
- $\overline{E E P 3}$  : EEPROM fault 3
- $\overline{E t n 1}$  : Auto-tuning error
- $\overline{E - 1 B}$  : VIA input detection error
- $\overline{E - 1 9}$  : Main unit CPU communication error
- $\overline{E - 2 0}$  : Excessive torque boost
- $\overline{E - 2 1}$  : CPU fault 2

- ★ Protective operation detection relay signals (FLA, FLB, FLC terminal signals) are not sent during use of the retry function. (Default setting)
- ★ To allow a signal to be sent to the protective action detection relay (FLA, B and C terminals) even during the retry process, assign the function 36 or 37 to  $F 1 3 2$ .
- ★ A virtual cooling time is provided for overload tripping ( $\overline{O L 1}$ ,  $\overline{O L 2}$ ,  $\overline{O L r}$ ).  
In this case, the retry function operates after the virtual cooling time and retry time.
- ★ In the event of tripping caused by an overvoltage ( $\overline{O P 1}$  -  $\overline{O P 3}$ ), the retry function will not be activated until the voltage in the DC section comes down to a normal level.
- ★ In the event of tripping caused by overheating ( $\overline{O H}$ ), the retry function will not be activated until the temperature in the inverter comes down low enough for it to restart operation.
- ★ Keep in mind that when  $F 6 0 2$  is set to 1 (trip retained), the retry function will not be performed, regardless of the setting of  $F 3 0 3$ .
- ★ During retrying, the blinking display will alternate between  $r t r y$  and the monitor display specified by status monitor display mode selection parameter  $F 7 1 0$ .
- ★ The number of retries will be cleared if the inverter is not tripped for the specified period of time after a successful retry.  
"A successful retry" means that the inverter output frequency reaches the command frequency without causing the inverter to re-trip.

## 6.13.4 Dynamic (regenerative) braking - For abrupt motor stop

**F304**: Dynamic braking selection

**F308**: Dynamic braking resistance

**F309**: Dynamic braking resistor capacity

- Function
  - The VFS11 does not contain a braking resistor. Connect an external braking resistor in the following cases to enable dynamic braking function:
    - when decelerating the motor abruptly or if overvoltage tripping (OP) occurs during deceleration stop
    - when a continuous regenerative status occurs during downward movement of a lift or the winding-out operation of a tension control machine
    - when the load fluctuates and a continuous regenerative status results even during constant speed operation of a machine such as a press

[Parameter setting]

Title	Function	Adjustment range	Default setting
<b>F304</b>	Dynamic braking selection	0: Disabled 1: Enabled (Resistor overload protection enabled)	0
<b>F308</b>	Dynamic braking resistance	1.0-1000 ( $\Omega$ )	Depending on models (See Section 11, K-15)
<b>F309</b>	Dynamic braking resistor capacity	0.01-30.00 (kW)	

### 1) Connecting an external braking resistor (optional)

Separate-optional resistor (with thermal fuse)

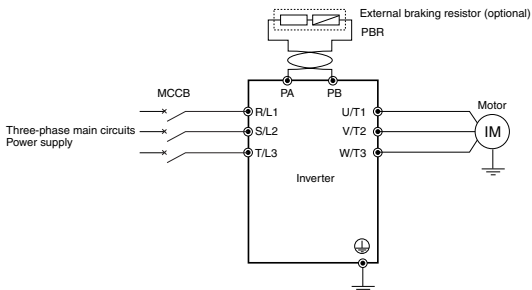

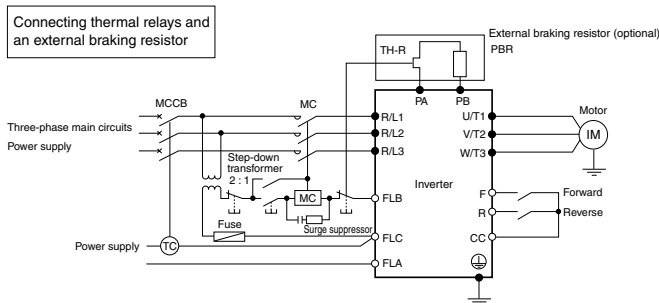

Note 1: A TC (Trip coil) is connected, as shown in this figure, when an MCCB with a trip coil is used instead of an MC. A step-down transformer is needed for every 400V-class inverter, but not for any 200V-class inverter.

Note 2: As a last resort to prevent fire, be sure to connect a thermal relay (THR). Although the inverter has a means of preventing overload and overcurrent to protect the braking resistor, the thermal relay is activated in case the protection function fails to work. Select and connect a thermal relay (THR) appropriate to the capacity (wattage) of the braking resistor.

#### [Parameter setting]

Title	Function	Default setting
F 304	Dynamic braking selection	1
F 305	Overtoltage limit operation	1
F 308	Dynamic braking resistance	Any value
F 309	Dynamic braking resistor capacity	Any value

- ☆ To connect a dynamic braking resistor, set the overvoltage limit operation parameter *F 305* to "1" (Disabled).
- ☆ To use this inverter in applications that create a continuously regenerative status (such as downward movement of a lift, a press or a tension control machine), or in applications that require slowdown stopping of a machine with a significant load inertial moment, increase the dynamic braking resistor capacity according to the operation rate required.
- ☆ To connect an external dynamic braking resistor, select one with a resultant resistance value greater than the minimum allowable resistance value. Be sure to set the appropriate operation rate in *F 308* and *F 309* to ensure overload protection.
- ☆ When using a braking resistor with no thermal fuse, connect and use a thermal relay as a control circuit for cutting power off.

## 2) Optional dynamic braking resistors

Optional dynamic braking resistors are listed below. All these resistors are 3%ED in operation rate

Inverter type	Braking resistor/Braking unit	
	Type-form	Rating
VFA11S-2002PI to 2007PL VFS11-2002PM to 2007PM	PBR-2007	120W-200Ω
VFS11S-2015PL to 2022PL VFS11-2015PM to 2022PM	PBR-2022	120W-75Ω
VFS11-2037PM	PBR-2037	120W-40Ω
VFS11-2055PM	PBR3-2055	240W-20Ω (120W-40Ωx2P)
VFS11-2075PM	PBR3-2075	440W-15Ω (220W-30Ωx2P)
VFS11-2110PM	PBR3-2110	660W-10Ω (220W-30Ωx3P)
VFS11-2150PM	PBR3-2150	880W-7.5Ω (220W-30Ωx4P)
VFS11-4004PL to 4022PL	PBR-2007	120W-200Ω
VFS11-4037PL	PBR-4037	120W-160Ω
VFS11-4055PL	PBR3-4055	240W-80Ω (120W-160Ωx2P)
VFS11-4075PL	PBR3-4075	440W-60Ω (220W-120Ωx2P)
VFS11-4110PL	PBR3-4110	660W-40Ω (220W-120Ωx3P)
VFS11-4150PL	PBR3-4150	880W-30Ω (220W-120Ωx4P)
VFS11-6007	-	62W-2850Ω
VFS11-6015	-	124W-1450Ω
VFS11-6022	-	186W-950Ω
VFS11-6037	-	371W-480Ω
VFS11-6055	-	618W-290Ω
VFS11-6075	-	928W-190Ω
VFS11-6110	-	1237W-140Ω
VFS11-6150	-	1546W-115Ω

Note 1: The data in Rating above refer to the resultant resistance capacities (watts) and resultant resistance values (Ω).

The numeric values inside parentheses refer to the internal compositions of resistors.

Note 2: Braking resistors for frequent regenerative braking are optionally available. For more information, contact your nearest Toshiba inverter distributor.

Note 3: Type-form of "PBR-" indicate "with thermal fuse" type.

"PBR3-" indicate "with thermal relay" type".

### 3) Minimum resistances of connectable braking resistors

The minimum allowable resistance values of the externally connectable braking resistors are listed in the table below.

Do not connect braking resistors with smaller resultant resistances than the listed minimum allowable resistance values.

Inverter rated output capacity (kW)	[240V Class]		[500V Class]		[600V Class]	
	Resistance of standard option	Minimum allowable resistance	Resistance of standard option	Minimum allowable resistance	Resistance of standard option	Minimum allowable resistance
0.2	200Ω	55Ω	-	-	-	-
0.4	200Ω	55Ω	200Ω	114Ω	-	-
0.55	200Ω	55Ω	-	-	-	-
0.75	200Ω	55Ω	200Ω	114Ω	2850Ω	115Ω
1.5	75Ω	44Ω	200Ω	67Ω	1450Ω	68Ω
2.2	75Ω	33Ω	200Ω	67Ω	950Ω	68Ω
4.0	40Ω	16Ω	160Ω	54Ω	480Ω	54Ω
5.5	20Ω	12Ω	80Ω	43Ω	290Ω	44Ω
7.5	15Ω	12Ω	60Ω	28Ω	190Ω	28Ω
11	10Ω	5Ω	40Ω	16Ω	140Ω	16Ω
15	7.5Ω	5Ω	30Ω	16Ω	115Ω	16Ω

Note: Be sure to set **F308** (Dynamic braking resistance) at the resistance of the dynamic braking resistor connected.

## 6.13.5 Avoiding overvoltage tripping

**F305**: Overvoltage limit operation

**F626**: Overvoltage stall protection level

- Function

These parameters are used to keep the output frequency constant or increase it to prevent overvoltage tripping in case the voltage in the DC section rises during deceleration or varying speed operation. The deceleration time during overvoltage limit operation may increase above the designated time.

Overvoltage limit operation level

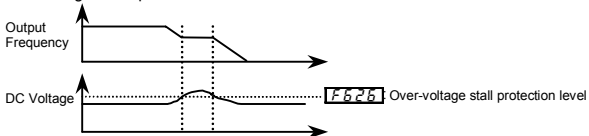

[Parameter setting]

Title	Function	Adjustment range	Default setting
F305	Overvoltage limit operation (Slowdown stop mode selection)	0: Enabled 1: Disabled 2: Enabled (Quick deceleration) 3: Enabled (Dynamic quick deceleration)	2
F626	Overvoltage limit operation level	100-150%	240V/600V: 134% 500V models: 140%

- ★ If F305 is set to 2 (quick deceleration), the inverter will increase the voltage to the motor (over-excitation control) to increase the amount of energy consumed by the motor when the voltage reaches the overvoltage protection level, and therefore the motor can be decelerated more quickly than normal deceleration.
- ★ If F305 is set to 3 (dynamic quick deceleration), the inverter will increase the voltage to the motor (over-excitation control) to increase the amount of energy consumed by the motor as soon as the motor begins to slow down, and therefore the motor can be decelerated still more quickly than quick deceleration.

## 6.13.6 Output voltage adjustment/Supply voltage correction

**ULU**: Base frequency voltage 1

**F307**: Supply voltage correction (output voltage adjustment)

- Function

**Base frequency voltage1**

The F307 parameter adjusts the voltage corresponding to the base frequency 1 ULU so that no voltage exceeding the ULU set value is put out. (This function is enabled only when F307 is set to either "0" or "1".)

**Supply voltage correction**

The F307 parameter maintains a constant V/F ratio, even when the input voltage decreases. The torque during low-speed operation is prevented from decreasing.

Maintains a constant V/F ratio, even when the input voltage fluctuates.

Output voltage adjustment ..... Limits the voltage at frequencies exceeding the base frequency. Applied when operating a special motor with low induced voltage.

[Parameter setting]

Title	Function	Adjustment range	Default setting
ULU	Base frequency voltage1	50-330 (V) : 240V class 50-660 (V) : 500 / 600V class	230 (240V class) 460 (500V class) 575 (600V class)
F307	Supply voltage correction (output voltage limited)	0: Supply voltage uncorrected, output voltage limited 1: Supply voltage corrected, output voltage limited 2: Supply voltage uncorrected, output voltage unlimited 3: Supply voltage corrected, output voltage unlimited	2 (WP, WN) 3 (AN)

- ★ If  $F307$  is set to "0" or "2", the output voltage will change in proportion to the input voltage.
- ★ Even if the base frequency voltage ( $uL$  parameter) is set above the input voltage, the output voltage will not exceed the input voltage.
- ★ The rate of voltage to frequency can be adjusted according to the rated motor capacity. For example, setting  $F307$  to "0" or "1" prevents the output voltage from increasing, even if the input voltage changes when operation frequency exceeds the base frequency.
- ★ When the V/F control mode selection parameter ( $P4$ ) is set to any number between 2 and 5, the supply voltage is corrected regardless of the setting of  $F307$ .

[0: Supply voltage uncorrected, output voltage limited]

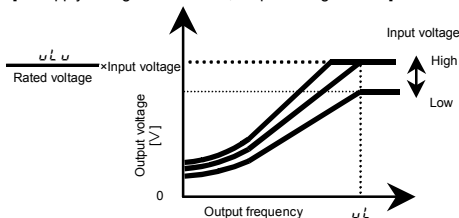

\* The above applies when V/F control mode selection parameter  $P4$  is set to "0" or "1".

$\frac{uL}{\text{Rated voltage}} > 1$  the output voltage can be prevented from exceeding the input voltage.

[1: Supply voltage corrected, output voltage limited]

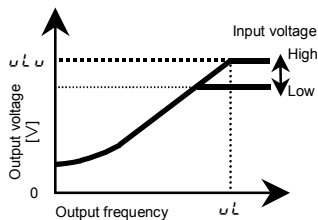

[2: Supply voltage uncorrected, output voltage unlimited]

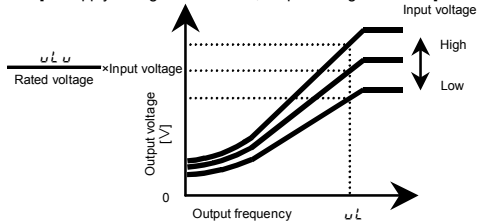

\* The above applies when V/F control mode selection parameter  $P4$  is set to "0" or "1".

$\frac{uL}{\text{Rated voltage}} > 1$  the output voltage can be prevented from exceeding the input voltage.

[3: Supply voltage corrected, output voltage unlimited]

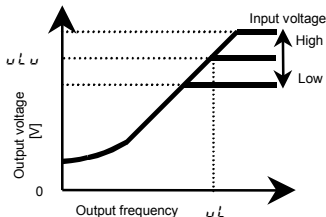

\* Even if  $uL$  is set for an output voltage lower than the input voltage, the output voltage will exceed the voltage adjusted by  $uL$  when the output frequency is higher than the base frequency  $1 uL$ .

## 6.13.7 Canceling the operation command

**F311**: Reverse-run prohibition

- Function  
This function prevents the motor from running in the forward or reverse direction when it receives the wrong operation signal.

[Parameter setting]

Title	Function	Adjustment range	Default setting
F311	Reverse-run prohibition	0: Forward/reverse run permitted 1: Reverse run prohibited 2: Forward run prohibited	0

## 6.14 Droop control

**F320**: Droop gain

**F323**: Droop insensitive torque band

- Function  
Droop control has the function of preventing loads from concentrating at a specific motor because of a load imbalance when multiple inverters are used to operate one machine.  
These parameters are used to allow the motor to "slip" according to the load torque current. Using these parameters, the insensitive torque band and the gain can be adjusted.

[Parameter setting]

Title	Function	Adjustment range	Default setting
F320	Droop gain	0-100%	0%
F323	Droop insensitive torque band	0-100%	10%

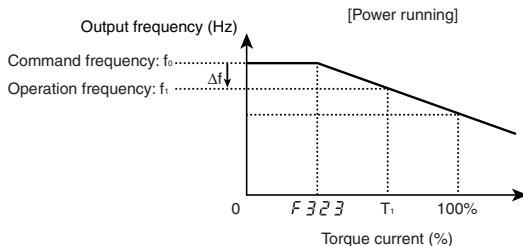

- ★ The droop control function refers to the function of operating the power-running motor at operating frequency  $f_1$  (Hz) that is lower than command frequency  $f_0$  (Hz) by droop frequency  $\Delta f$  (Hz) when the torque current is  $T_1$  (%). (See the above figure.)
- The droop frequency  $\Delta f$  can be calculated, using the following expression.  
Droop frequency  $\Delta f$  (Hz) = base frequency  $\omega \cdot L$  ×  $F 3 2 0$  × (Torque current  $T_1 - F 3 2 3$ )
- When the torque current is above the specified droop insensitive torque band ( $F 3 2 3$ ), the frequency is reduced during power running or increased during regenerative braking. The above figure shows an example of the operating frequency during power running. During regenerative braking, control is performed in such a way as to increase the frequency.
- The droop function is activated above the torque current set with  $F 3 2 3$ .
- The amount of droop frequency  $\Delta f$  varies depending on the amount of torque current  $T_1$ .

Note: If the base frequency  $\omega \cdot L$  exceeds 100Hz, count it as 100Hz.  
Control is exercised between the starting frequency ( $F 2 4 0$ ) and the maximum frequency ( $F H$ ).

[An example of calculation]

Parameter setting: Base frequency  $\omega \cdot L$  = 60 (Hz), droop gain  $F 3 2 0$  = 10 (%)

Droop insensitive torque band  $F 3 2 3$  = 30 (%)

Droop frequency  $\Delta f$  (Hz) and operating frequency  $f_1$  when command frequency  $f_0$  is 50 (Hz) and torque current  $T_1$  is 100 (%) are as follows.

$$\begin{aligned} \text{Droop frequency } \Delta f \text{ (Hz)} &= \omega \cdot L \times F 3 2 0 \times (T_1 - F 3 2 3) \\ &= 60 \text{ (Hz)} \times 10 \text{ (\%)} \times (100 \text{ (\%)} - 30 \text{ (\%)}) \\ &= 4.2 \text{ (Hz)} \end{aligned}$$

$$\text{Operation frequency } f_1 \text{ (Hz)} = f_0 - \Delta f = 50 \text{ (Hz)} - 4.2 \text{ (Hz)} = 45.8 \text{ (Hz)}$$

## 6.15 Braking setting functions

**F 3 4 2**: Braking mode selection

**F 3 4 3**: Release frequency

**F 3 4 4**: Release time

**F 3 4 5**: Creeping frequency

**F 3 4 6**: Creeping time

- Function  
Setting functions to control braking timing.

Note: For these parameters, contact your nearest Toshiba inverter distributor.

## 6.16 Conducting PID control

**F359**: PID control waiting time

**F360**: PID control

**F362**: Proportional gain

**F363**: Integral gain

**F366**: Differential gain

- Function

Using feedback signals (4 to 20mA, 0 to 10V) from a detector, process control can be exercised, for example, to keep the airflow, amount of flow or pressure constant.

[Parameter setting]

Title	Function	Adjustment range	Default setting
<b>F359</b>	PID control waiting time	0-2400 [sec]	0
<b>F360</b>	PID control	0: Disabled, 1: Enabled	0
<b>F362</b>	Proportional gain	0.01-100.0	0.30
<b>F363</b>	Integral gain	0.01-100.0	0.20
<b>F366</b>	Differential gain	0.00-2.55	0.00

### 1) External connection

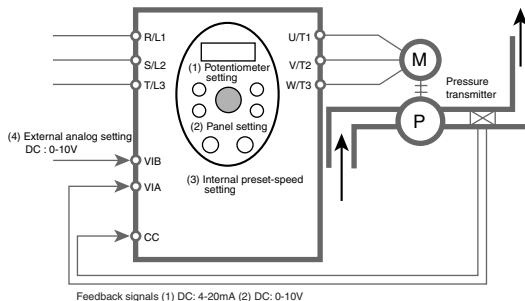

## 2) Types of PID control interfaces

Process quantity input data (frequency) and feedback input data can be combined as follows for the PID control of the VF-S11:

Process quantity input data (frequency setting)		Feedback input data
Setting method	Frequency setting mode selection 1 <i>F R Q d / F 2 0 7 / F 2 0 0</i>	
(1) Internal potentiometer setting	0	External analog input VIA (DC:4-20V / DC:0-10V)
(2) Panel input setting	3	
(3) Internal preset-speed setting	-( <i>L R d</i> =0)	
(4) External analog setting VIB (DC: 0-10V)	2	

Note 1: About the setting of *F R Q d*, *F 2 0 7* and *F 2 0 0*: Do not enable VIA using these parameters, because the VIA terminal is used for feedback signals.

Note 2: To make the inverter send out a signal that indicates whether the amount of feedback agree with (or reaches) the amount of processing, assign the function 52 or 53 to an unassigned output terminal. You can also specify a frequency agreement detection range (*F I 5 7*). For more information, see 6.3.4.

## 3) Setting PID control

Set "I" in the extended parameter *F 3 5 0* (PID control).

- (1) Set parameters *R L L* (acceleration time), and *d E L* (deceleration time) to the system fitting values.
- (2) To limit the output frequency, set parameters *U L* (upper limit frequency) and *L L* (lower limit frequency). If process quantities are set from the operation panel, however, the process quantity setting range will be limited by the settings of *U L* and *L L*.

## 4) Adjusting the PID control gain level

Adjust the PID control gain level according to the process quantities, the feedback signals and the object to be controlled.

The following parameters are provided for gain adjustment:

Parameter	Setting range	Default setting
<i>F 3 5 2</i> (P-gain)	0.01-100.0	0.30
<i>F 3 5 3</i> (I-gain)	0.01-100.0	0.20
<i>F 3 5 5</i> (D-gain)	0.00-2.55	0.00

### F 3 5 2 (P-gain adjustment parameter)

This parameter adjusts the proportional gain level during PID control. A correction value proportional to the particular deviation (the difference between the set frequency and the feedback value) is obtained by multiplying this deviation by the parameter setting.

A larger P-gain adjustment value gives faster response. Too large an adjustment value, however, results in an unstable event such as hunting.

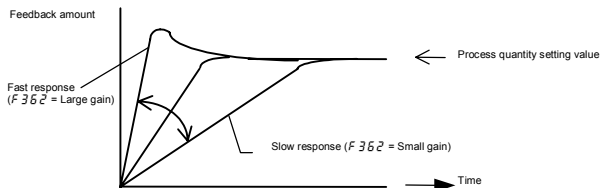

### F 3 5 3 (I-gain adjustment parameter)

This parameter adjusts the integral gain level during PID control. Any deviations remaining unremoved during proportional action are cleared to zero (residual deviation offset function).

A larger I-gain adjustment value reduces residual deviations. Too large an adjustment value, however, results in an unstable event such as hunting.

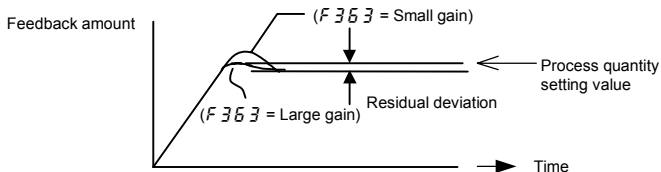

- ☆ If one of input terminals is assigned input terminal function 65 (PID control integral value clear), integral value is always 0 (zero) during the input terminal on.

## F366 (D-gain adjustment parameter)

This parameter adjusts the differential gain level during PID control. This gain increases the speed of response to a rapid change in deviation (difference between the frequency setting and the amount of feedback).

Note that setting the gain more than necessary may cause great fluctuations in output frequency, and thus operation to become unstable.

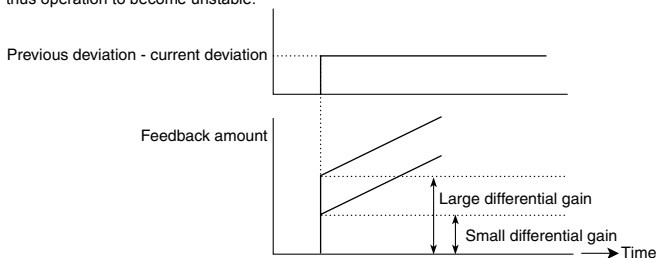

## 5) Adjusting analog command voltages

To use external analog setting (VIB) or feedback input (VIA), perform voltage-scaling adjustments (input point setting) as required. See Section 6.5.2 for further details.

If the feedback input data is too small, voltage-scaling adjustment data can also be used for gain adjustment.

Example of VIB terminal setting

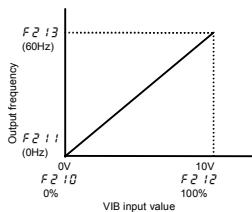

Example of VIA terminal setting (voltage input)

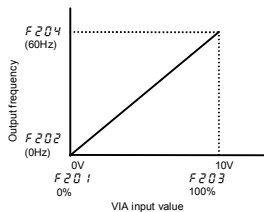

Example of VIA terminal setting (current input)

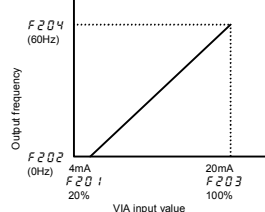

## 6) Setting the time elapsed before PID control starts

You can specify a waiting time for PID control to prevent the inverter from starting PID control before the control system becomes stable, for example, after start-up.

The inverter ignores feedback input signals, carries out operation at the frequency determined by the amount of processing for the period of time specified with F359 and enters the PID control mode after a lapse of the specified time.

## 6.17 Setting motor constants

### 6.17.1 Setting motor constants 1

**F400**: Auto-tuning

**F401**: Slip frequency gain

**F402**: Automatic torque boost value

**F415**: Motor rated current

**F416**: Motor no-load current

**F417**: Motor rated speed

**F418**: Speed control response coefficient

**F419**: Speed control stable coefficient

To use vector control, automatic torque boost and automatic energy saving, motor constant setting (motor tuning) is required. The following three methods are available to set motor constants.

- 1) Using the torque boost setting macro function (**P12**) for setting the V/F control mode selection (**P1**) and auto-tuning (**F400**) at the same time
- 2) Setting V/F control mode selection (**P1**) and auto-tuning (**F400**) independently
- 3) Combining the V/F control mode selection (**P1**) and manual tuning

★ Check to be sure that the setting of the parameter  $\omega_L$  and that of the parameter  $\omega_{L\omega}$  agree with the base frequency (rated rotational speed) and base frequency voltage (rated voltage) of the motor to be operated, respectively. If not, set the parameters correctly.

★ When using the inverter to control the operation of a motor smaller in capacity by one grade or more, be sure to set the motor rated current setting parameter (**F415**) properly.

★ Vector control may not operate properly if the motor capacity differs from the applicable rated capacity of the inverter by more than two grades.

If current waveforms oscillate during operation, increase the speed control stability factor (**F419**). This is effective in suppressing oscillation.

## [Selection 1: Setting by parameter setting macro torque boost]

This is the easiest of the available methods. It conducts vector control and auto-tuning at the same time.

Set  $AU2$  to 1  
(Automatic torque boost + auto-tuning)

Set  $AU2$  to 2  
(Vector control + auto-tuning).

Set  $AU2$  to 3  
(Energy-saving + auto-tuning)

See Section 5.2 for details of the setting method.

## [Selection 2: Setting vector control and auto-tuning independently]

This method sets sensorless vector control or automatic torque boost, and auto-tuning independently.

Specify the control mode selection parameter ( $PE$ ) and then set auto-tuning.

Set the auto-tuning parameter  $F400$  to 2  
(Auto-tuning enabled)

[Parameter setting]

Title	Function	Adjustment range	Default setting
$F400$	Auto-tuning	0: Auto-tuning disabled (use of internal parameters) 1: Application of individual settings of $F402$ (after execution: 0) 2: Auto-tuning enabled (after execution: 0)	0

Set  $F400$  to  $2$  before the start of operation. Tuning is performed at the start of the motor.

★ Precautions on auto-tuning

- (1) Conduct auto-tuning only after the motor has been connected and operation completely stopped.  
If auto-tuning is conducted immediately after operation stops, the presence of a residual voltage may result in abnormal tuning.
- (2) Voltage is applied to the motor during tuning even though it barely rotates. During tuning, " $EEn$ " is displayed on the operation panel.
- (3) Tuning is performed when the motor starts for the first time after  $F400$  is set to  $2$ .  
Tuning is usually completed within three seconds. If it is aborted, the motor will trip with the display of  $EEn$  and no constants will be set for that motor.
- (4) High-speed motors, high-slip motors or other special motors cannot be auto-tuned. For these motors, perform manual tuning using Selection 3 described below.
- (5) Provide cranes and hoists with sufficient circuit protection such as mechanical braking. Without sufficient circuit protection, the resulting insufficient motor torque during tuning could create a risk of machine stalling/falling.
- (6) If auto-tuning is impossible or an " $EEn$ " auto-tuning error is displayed, perform manual tuning with Selection 3.
- (7) If the inverter is tripped during auto-tuning because of an output phase failure ( $EPH$ ), check if the inverter is connected to the correctly. A check for output phase failures is made during auto-tuning, regardless of the setting of the output phase failure detection mode selection parameter ( $F605$ ).

[Selection 3: Setting vector control and manual tuning independently]

If an " $EEn$ " tuning error is displayed during auto-tuning or when vector control characteristics are to be improved, independent motor constants can be set.

Title	Function	Adjustment range	Default setting
$F401$	Slip frequency gain	0-150 (%)	50
$F402$	Automatic torque boost value	0.0-30.0 (%)	Depends on the capacity (See Section 11, K-15)
$F415$	Motor rated current	0.1-100.0 (A)	
$F416$	Motor no-load current	10-90 (%)	
$F417$	Motor rated rotational speed	100-32000 ( $\text{min}^{-1}$ )	1410 (WP) 1710 (WN, AN)
$F418$	Speed control response coefficient	1-150	40
$F419$	Speed control stability coefficient	1-100	20
$EHr$	Motor electronic thermal protection level 1	10-100 (%) / (A)	100

Setting procedure Adjust the following parameters:

- F401**: Set the compensation gain for the slipping of the motor. A higher slip frequency reduces motor slipping correspondingly. After setting **F417**, set **F401** to adjust in detail.
- F402**: Adjust the primary resistive component of the motor. Decreases in torque due to a possible voltage drop during low-speed operation can be suppressed by setting a large value in this parameter. (Perform adjustments according to the actual operation.)
- F415**: Set the rated current of the motor. For the rated current, see the motor's nameplate or test report.
- F416**: Set the ratio of the no-load current of the motor to the rated current. Enter the value in % that is obtained by dividing the no-load current specified in the motor's test report by the rated current.
- F417**: Set the rated rotational speed of the motor. For the rated current, see the motor's nameplate or test report.
- F418**: Using this parameter along with **F419**, adjust the speed of response to the frequency command.
- F419**: Using this parameter along with **F418**, adjust the speed of response to the frequency command.
- \* How to make adjustments according to the moment of inertia of the load  
The moment of inertia of the load (including that of the motor shaft) was set at the factory on the assumption that it would be three times as large as that of the motor shaft.  
If this assumption does not hold, calculate the values to be entered in **F418** and **F419**, using the following equations.

$$F418 = 40 \times \sqrt{a/3}$$

$$F419 = 20 \times \sqrt{a/3}$$

Where  $a$  is the times by which the moment of inertia of the load is larger than that of the motor. After the above adjustments, if necessary, make fine adjustments as described below.

- To increase the response speed: Increase the setting of **F418**.
- To reduce the response speed: Decrease the setting of **F418**.
- If overshooting or hunting occurs: Increase the setting of **F419**.
- If reduction gears or the like squeak: Increase the setting of **F419**.
- If an over-voltage trip occurs on completion of acceleration: Increase the setting of **F419**.

When making the above adjustments, increase or decrease settings in steps of 10% or so while checking how things change.

Note also that, depending on the settings of **F418** and **F419**, the frequency may exceed the upper-limit frequency if the inverter is set so as to accelerate the load in the shortest possible time.

- tHr**: If the rated capacity of the motor is one size smaller than that of the inverter, lower the thermal protective level according to the rated current of the motor.

\* Sensorless vector control may not operate properly if the motor capacity differs from the applicable rated capacity of the inverter by more than two grades.

## 6.17.2 Setting motor constants 2 (Details)

**F480**: Exciting current coefficient

**F485**: Stall prevention control coefficient 1

**F492**: Stall prevention control coefficient 2

**F494**: Motor adjustment coefficient

**F495**: Maximum voltage adjustment coefficient

**F496**: Waveform switching adjustment coefficient

- \* The following parameters enables you to make adjustments more finely.

Title	Function	Adjustment range	Default setting
<i>F 480</i>	Exciting current coefficient	100-130 (%)	100
<i>F 485</i>	Stall prevention control coefficient 1	10-250	100
<i>F 492</i>	Stall prevention control coefficient 2	50-150	100
<i>F 494</i>	Motor adjustment coefficient	0-200	Depends on the capacity
<i>F 495</i>	Maximam voltage adjustment coefficient	90-110 (%)	104
<i>F 496</i>	Waveform switching adjustment coefficient	0.1-14.0(kHz)	0.2

*F 480*: Used to fine adjust the magnetic field increase rate in low-speed range. To increase the torque in low-speed range, specify a larger value for *F 480*. Note that this parameter should be adjusted only when enough torque cannot be obtained, even though auto-tuning (*F 400=2*) was made after the setting of the parameters *F 401* through *F 419*. Note also that adjusting this parameter may cause an increase in the no-load current in low-speed range. If the no-load current exceeds the rated current, do not adjust this parameter.

*F 485*: Using this parameter along with *F 492* adjusts characteristics in a region in which the frequency is above the base frequency (region where the field is weak).

*F 492*: Using this parameter along with *F 485* adjusts characteristics in a region in which the frequency is above the base frequency (region where the field is weak).

\* How to make adjustments in a region (region where magnetic field is weak) above the base frequency

If a heavy load is applied instantaneously (or transiently), the motor may stall before the load current reaches the current set with the stall prevention level 1 parameter (*F 501*). In many cases, this kind of stall can be avoided by gradually reducing the setting of *F 485*.

A drop in supply voltage may cause fluctuations of the load current or vibration of the motor. In some cases, such phenomena can be eliminated by changing the setting of *F 492* to between 80 and 90. However, this may cause an increase in load current, so that it is also necessary to adjust the setting of the electronic thermal protective level 1 parameter (*LHr*) properly according to the motor capacity.

*F 494*: There is no need to adjust this parameter under normal conditions. (Do not change the setting, unless otherwise instructed by Toshiba technical staff)

*F 495*: Specify a larger value for *F 495* to secure as high an output voltage as possible in a region (region where magnetic field is weak) above the base frequency. Setting *F 495* to a larger value may cause the motor to vibrate or gears to squeak. If such a phenomenon occurs, do not adjust this parameter.

*F 496*: Specify a larger value for *F 496* if switching from a waveform to another results in a considerable increase in vibration and noise in middle-speed range (region between the start frequency and the base frequency). If no improvement can be made by specifying a larger value, do not adjust this parameter.

## 6.18 Acceleration/deceleration patterns 2 and 3

### 6.18.1 Selecting an acceleration/deceleration pattern

**F502**: Acceleration/deceleration 1 pattern

**F506**: S-pattern lower-limit adjustment amount

**F507**: S-pattern upper-limit adjustment amount

- Function

These parameters allow you to select an acceleration/deceleration pattern that suits the intended use.

Title	Function	Adjustment range	Default setting
<b>F502</b>	Acceleration/ deceleration 1 pattern	0: Linear, 1: S-pattern 1, 2: S-pattern 2	0
<b>F506</b>	S-pattern lower-limit adjustment amount	0-50%	10%
<b>F507</b>	S-pattern upper-limit adjustment amount	0-50%	10%

#### 1) Linear acceleration/deceleration

A general acceleration/  
deceleration pattern.

This pattern can usually be  
used.

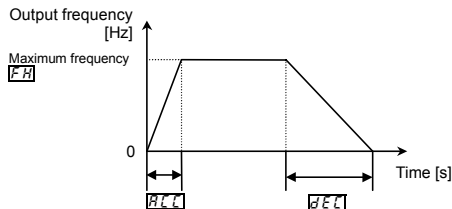

#### 2) S-pattern acceleration/deceleration 1

Select this pattern to  
accelerate/decelerate the  
motor rapidly to a high-speed  
region with an output  
frequency of 60Hz or more or  
to minimize the shocks  
applied during  
acceleration/deceleration.  
This pattern is suitable for  
pneumatic transport  
machines.

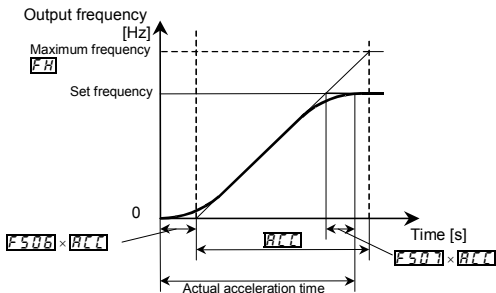

- 3) S-pattern acceleration/deceleration  
 Select this pattern to obtain slow acceleration in a demagnetizing region with a small motor acceleration torque. This pattern is suitable for high-speed spindle operation.

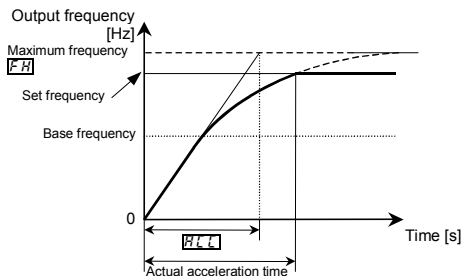

## 6.18.2 Selecting an acceleration/deceleration pattern

**F500**: Acceleration time 2

**F501**: Deceleration time 2

**F503**: Acceleration/deceleration 2 pattern

**F504**: Selecting an acceleration/deceleration pattern

**F505**: Acceleration/deceleration 1 and 2 switching frequency

**F510**: Acceleration time 3

**F511**: Deceleration time 3

**F512**: Acceleration/deceleration 3 pattern

**F513**: Acceleration/deceleration 2 and 3 switching frequency

- Function

Three acceleration times and three deceleration times can be specified individually. A method of selection or switching can be selected from among the following:

- 1) Selection by means of parameters
- 2) Switching by changing frequencies
- 3) Switching by means of terminals

Title	Function	Adjustment range	Default setting
F500	Acceleration time 2	0.0-3200 [sec]	10.0
F501	Deceleration time 2	0.0-3200 [sec]	10.0
F504	Selecting an acceleration/deceleration pattern 1: Acc / dec 1 2: Acc / dec 2 3: Acc / dec 3		1
F510	Acceleration time 3	0.0-3200 [sec]	10.0
F511	Deceleration time 3	0.0-3200 [sec]	10.0

## 1) Selection using parameters

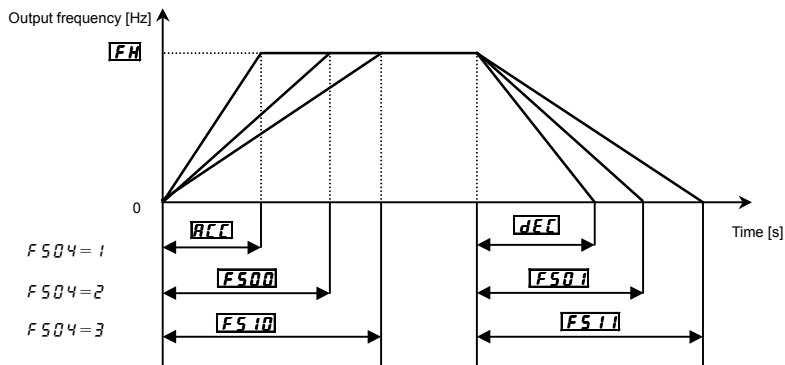

Acceleration/deceleration time 1 is initially set as the default. Acceleration/deceleration time 2 and 3 can be selected by changing the setting of the F504.

Enabled if  $CNd=1$  (panel input enabled)

## 2) Switching by frequencies - Switching the acceleration/deceleration time automatically at the frequency setting of F505.

Title	Function	Adjustment range	Default setting
F505	Acceleration/deceleration 1 and 2 switching frequency	0.0-UL	0.0
F513	Acceleration/deceleration 2 and 3 switching frequency	0.0-UL	0.0

Note: Acceleration/deceleration patterns are changed from pattern 1 to pattern 2 and from pattern 2 to pattern 3 in increasing order of frequency, regardless of the order in which frequencies are changed. (For example, if F505 is larger than F513, F513 pattern 1 is selected in the frequency range below the frequency set with F505.)

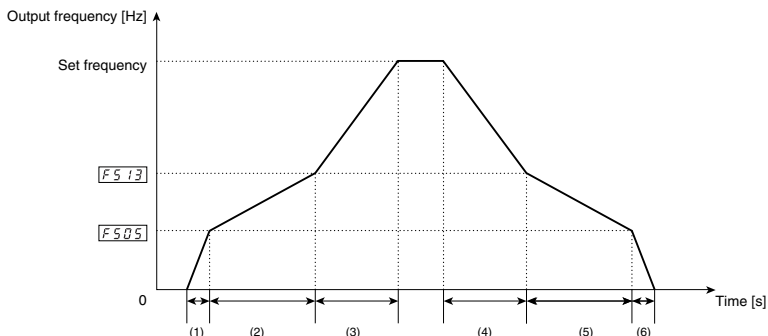

- (1) Acceleration at the gradient corresponding to acceleration time  $R\bar{C}\bar{C}$
- (2) Acceleration at the gradient corresponding to acceleration time  $F500$
- (3) Acceleration at the gradient corresponding to acceleration time  $F510$
- (4) Deceleration at the gradient corresponding to deceleration time  $F511$
- (5) Deceleration at the gradient corresponding to deceleration time  $F501$
- (6) Deceleration at the gradient corresponding to deceleration time  $d\bar{E}\bar{C}$

3) Switching using external terminals - Switching the acceleration/deceleration time via external terminals

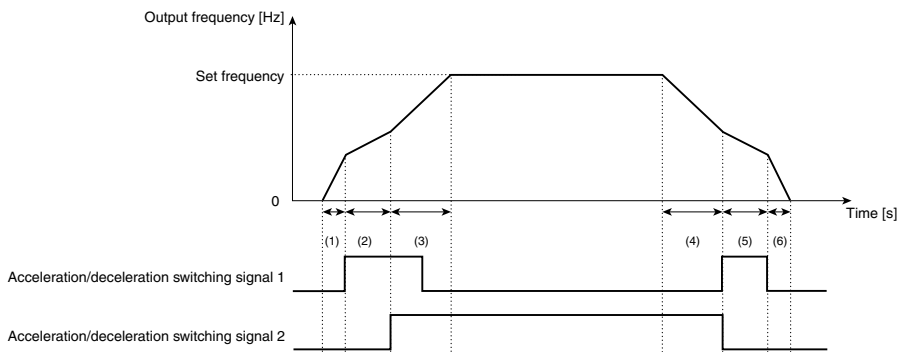

- (1) Acceleration at the gradient corresponding to acceleration time  $R\bar{C}\bar{C}$
- (2) Acceleration at the gradient corresponding to acceleration time  $F500$
- (3) Acceleration at the gradient corresponding to acceleration time  $F510$
- (4) Deceleration at the gradient corresponding to deceleration time  $F511$
- (5) Deceleration at the gradient corresponding to deceleration time  $F501$
- (6) Deceleration at the gradient corresponding to deceleration time  $d\bar{E}\bar{C}$

■ How to set parameters

a) Operating method: Terminal input

Set the operation control mode selection  $\llcorner \text{P} \text{Q} \text{d}$  to  $\text{Q}$ .

b) Use the S2 and S3 terminals for switching. (Instead, other terminals may be used.)

S2: Acceleration/deceleration switching signal 1

S3: Acceleration/deceleration switching signal 2

Title	Function	Adjustment range	Setting value
$F \ 1 \ 15$	Input terminal selection 5 (S2)	0-65	5 (the second acceleration/deceleration mode selection)
$F \ 1 \ 16$	Input terminal selection 6 (S3)	0-65	58 (the third acceleration/deceleration mode selection)

■ Acceleration/ deceleration pattern

Acceleration/deceleration patterns can be selected individually, using the acceleration/deceleration 1, 2 and 3 parameters.

- 1) Linear acceleration/deceleration
- 2) S-pattern acceleration/deceleration 1
- 3) S-pattern acceleration/deceleration 2

Title	Function	Adjustment range	Setting value
$F \ 5 \ 02$	Acceleration/ deceleration 1 pattern	0: Linear	0
$F \ 5 \ 03$	Acceleration/ deceleration 2 pattern	1: S-pattern 1	0
$F \ 5 \ 12$	Acceleration/ deceleration 3 pattern	2: S-pattern 2	0

★ For an explanation of acceleration/deceleration patterns, see 6.18.1.

★ Both the settings of the S-pattern lower-limit and upper-limit adjustment parameters ( $F \ 5 \ 05$  and  $F \ 5 \ 07$ ) are applied to any acceleration/deceleration S-pattern.

## 6.19 Protection functions

### 6.19.1 Setting motor electronic thermal protection

**F~~HR~~**: Motor electronic thermal protection level 1

**F~~173~~**: Motor electronic thermal protection level 2

**F~~607~~**: Motor 150%-overload time limit

- Function  
This parameter allows selection of the appropriate electronic thermal protection characteristics according to the particular rating and characteristics of the motor.

#### ■ Parameter setting

Title	Function	Adjustment range	Default setting
<b>F<del>HR</del></b>	Motor electronic thermal protection level 1	10-100 (%) / (A)	100
<b>F<del>173</del></b>	Motor electronic thermal protection level 2	10-100 (%) / (A)	100
<b>F<del>607</del></b>	Motor 150%-overload time limit	10-2400 (s)	300



For more details, see 5.13.

Note. The 100% standard value is the rated output current indicated on the nameplate.

### 6.19.2 Setting current stall

**F~~601~~**: Stall prevention level 1

**F~~185~~**: Stall prevention level 2

 Caution	
 Prohibited	<ul style="list-style-type: none"> <li>Do not set the stall prevention level (<b>F<del>601</del></b>) extremely low. If the stall prevention level parameter (<b>F<del>601</del></b>) is set at or below the no-load current of the motor, the stall preventive function will be always active and increase the frequency when it judges that regenerative braking is taking place. Do not set the stall prevention level parameter (<b>F<del>601</del></b>) below 30% under normal use conditions.</li> </ul>

- Function  
This parameter adjusts the output frequency by activating a current stall prevention function against a current exceeding the **F~~601~~**-specified level.

#### ■ Parameter setting

Title	Function	Adjustment range	Default setting
<b>F<del>601</del></b>	Stall prevention level 1	10-199 (%) / (A), 200: Deactivated	150
<b>F<del>185</del></b>	Stall prevention level 2		

[Display during operation of the stall prevention]

During an  $\text{OL}$  alarm status, (that is, when there is a current flow in excess of the stall prevention level), the output frequency changes. At the same time, to the left of this value, " $\text{OL}$ " is displayed flashing on and off.

Example of display

$\text{OL} 50$

- ★ The switching from  $F601$  to  $F185$  can be performed by entering a command through terminals. For more details, see 6.4.1.

Note. The 100% standard value is the rated output current indicated on the nameplate.

## 6.19.3 Inverter trip retention

$F602$ : Inverter trip retention selection

- Function  
If the inverter trips, this parameter will retain the corresponding trip information. Trip information that has thus been stored into memory can be displayed, even after power has been reset.

[Parameter setting]

Title	Function	Adjustment range	Default setting
$F602$	Inverter trip retention selection	0: Cleared if power is turned off 1: Retained even if power is turned off	0

- ★ The causes of up to four trips that occurred in the past can be displayed in status monitor mode.
- ★ Data displayed in status monitor mode when the inverter is tripped is cleared when power is turned off. Past trip records can be displayed.
- ★ Trip records are retained even if power is turned off and turned back on during retry operation.

■ Flow of operation when  $F602 = 1$

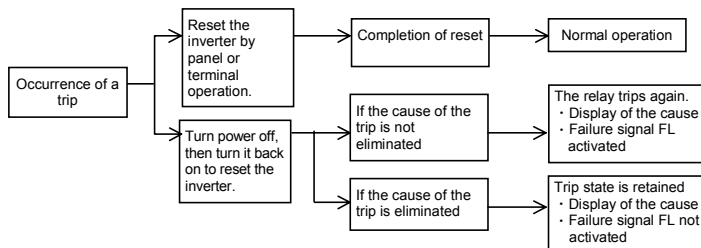

## 6.19.4 Emergency stop

**F603**: Emergency stop

**F604**: Emergency DC braking time

- Function

These parameters allow you to specify how to stop operation using an external control device when an external trip occurs. When operation is stopped, the trip *E* and the FL relay also are activated.

When setting *F603* to 2 (emergency DC braking), set also *F251* (DC braking rate) and *F604* (emergency braking time)

### 1) External trip stop via terminals

The external trip stop function can be executed via the a-contact. Proceed as follows to assign an external stopping terminal and select the stopping method:

[Parameter setting]

Title	Function	Adjustment range	Default setting
<i>F603</i>	Emergency stop selection	0: Coast stop 1: Slowdown stop 2: Emergency DC braking	0
<i>F604</i>	Emergency DC braking time	0.0 ~ 20.0 [sec]	1.0
<i>F251</i>	DC braking current	0-100 (%)	50

(Example of terminal assignment): Assigning the trip stop function to the RES terminal

Title	Function	Adjustment range	Setting
<i>F113</i>	Input terminal selection 3 (RES)	0-65	11 (External trip stop)

Note 1) Emergency stopping via the specified terminal is possible, even during panel operation.

Note 2) If DC braking is not needed to bring the motor to a stop under normal conditions, although *F603* is set to 2 (emergency DC braking), set the DC braking starting frequency (*F250*) at 0.0 Hz.

### 2) Emergency stopping from the operation panel

Emergency stopping from the operation panel is possible

by pressing the STOP key on the panel twice while the inverter is not in the panel control mode.

(1) Press the STOP key ..... "*E* *FF*" will blink.

(2) Press the STOP key once again..... Operation will come to a trip stop in accordance with the setting of the *F603* parameter.

After this, "*E*" will be displayed and a failure detection signal generated (FL relay deactivated).

## 6.19.5 Output phase failure detection

### **F605**: Output phase failure detection mode selection

- Function  
This parameter detects inverter output Phase failure. If the Phase failure status persists for one second or more, the tripping function and the FL relay will be activated. At the same time, a trip information *EPH0* will also be displayed.  
Set *F605* to 5 to open the motor-inverter connection by switching commercial power operation to inverter operation.  
Detection errors may occur for special motors such as high-speed motors.

*F605*=0: No tripping (FL relay deactivated).

*F605*=1: With the power on, the phase failure detection is enabled only at the start of the first operation.  
The inverter will trip if the Phase failure status persists for one second or more.

*F605*=2: The inverter checks for output phase failures each time it starts operation. The inverter will trip if the Phase failure status persists for one second or more.

*F605*=3: The inverter checks for output phase failures during operation. The inverter will trip if the Phase failure status persists for one second or more.

*F605*=4: The inverter checks for output phase failures at the start of and during operation. The inverter will trip if the Phase failure status persists for one second or more.

*F605*=5: If it detects an all-phase failure, it will restart on completion of reconnection.

The inverter does not check for output phase failures when restarting after a momentary power failure.

Note: A check for output phase failures is made during auto-tuning, regardless of the setting of this parameter.

Title	Function	Adjustment range	Default setting
<i>F605</i>	Output phase failure detection mode selection	0: Disabled 1: At start-up (Only one time after power is turned on) 2: At start-up (each time) 3: During operation 4: At start-up + during operation 5: Detection of cutoff on output side	0

## 6.19.6 Input phase failure detection

**F508**: Input phase failure detection mode selection

- Function

This parameter detects inverter input Phase failure. If the abnormal voltage status of main circuit capacitor persists for few minutes or more, the tripping function and the FL relay will be activated. Therefore, input phase failures cannot always be detected. A trip information *EPH 1* will be displayed.

If the power capacity is larger than the inverter capacity (more than 200kVA or more than 10 times), detection errors may occur. If this actually happens, install an AC or DC reactor .

*F508=0*: No tripping (Failure signal FL not activated)

*F508= 1*: Phase failure detection is enabled during operation. The inverter will trip if the abnormal voltage status of main circuit capacitor persists for ten minutes or more. (Failure signal FL activated)

Title	Function	Adjustment range	Default setting
<i>F508</i>	Input phase failure detection mode selection	0: Disabled, 1: Enabled	1

Note1: Setting *F508* to 0 (input phase failure detection: disabled) may result in a breakage of the capacitor in the inverter main circuit if operation is continued under a heavy load in spite of the occurrence of an input phase failure.

Note2: Parameter *F508* is invalid for single-phase input model.

## 6.19.7 Control mode for small current

**F509**: Small current detection current hysteresis

**F510**: Small current trip/alarm selection

**F511**: Small current detection current

**F512**: Small current detection time

- Function

The *F510* parameter allows the inverter to be tripped if a current smaller than the *F511*-specified value flows for more than the *F512*-specified time. When tripping is selected, enter the detection time to tripping. Trip information is displayed as "UL".

*F510=0*: No tripping (Failure signal FL not activated).

A small current alarm can be put out by setting the output terminal function selection parameter.

*F510= 1*: The inverter will trip (Failure signal FL activated) if a current below the current set with *F511* flows for the period of time specified with *F512* .

Title	Function	Adjustment range	Default setting
F609	Small current detection current hysteresis	1-20 (%)	10
F610	Small current trip/alarm selection	0: Alarm only 1: Tripping	0
F611	Small current detection current	0-100 (%) / (A)	0
F612	Small current detection time	0-255 [sec]	0

< Example of operation >

Output terminal function: 24 (UC) Low current detection

F610 = 0 (Alarm only)

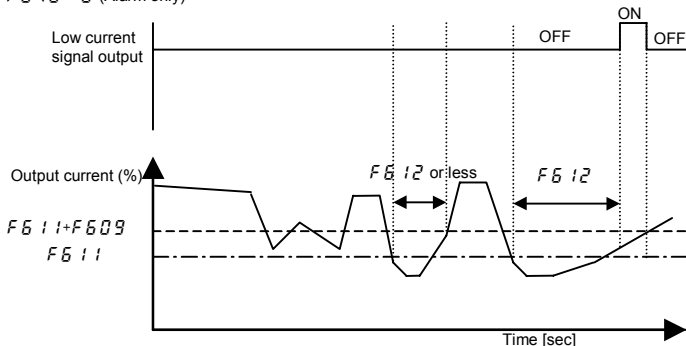

\* When setting F610 to 1 (Trip), trip after low current detection time setting of F612. After tripping, the low current signal remains ON.

## 6.19.8 Detection of output short-circuit

**F613**: Detection of output short-circuit during start-up

- Function  
This parameter detects inverter output short-circuit. It can be usually detected in the length of the standard pulse. When operating low-impedance motor such as high-speed motor, however, the short-time pulse should be selected.

F613=0: Detection is executed in the length of the standard pulse every time you start up the inverter.

F613=1: Detection is executed in the length of standard pulse only during the first start-up after putting on the power or after resetting.

F613=2: Detection is executed with the short-time pulse every time you start up the inverter.

F613=3: Detection is executed with the short-time pulse only for the first time after putting power on or after resetting.

Title	Function	Adjustment range	Default setting
<i>F6 13</i>	Detection of output short-circuit during start-up	0: Each time (standard pulse) 1: Only one time after power is turned on (standard pulse) 2: Each time (short-time pulse) 3: Only one time after power is turned on (short-time pulse)	0

### 6.19.9 Over-torque trip

***F6 15***: Over-torque trip/alarm selection

***F6 16***: Over-torque detection level

***F6 18***: Over-torque detection time

***F6 19***: Over-torque detection level hysteresis

- Function  
Use the *6 15* parameter to trip the inverter or to output the alarm if a torque current exceeding the *F6 16*-specified level flows for more than the *F6 18*-specified time. Trip information is displayed as "OL".

*F6 15*=0: ..... No tripping (FL relay deactivated).

An over-torque alarm can be put out by setting the output terminal function selection parameter.

*F6 15*=1: ..... The inverter is tripped (FL relay activated) only after a torque current exceeding the *F6 16*-specified level has been detected for more than the *F6 18*-specified time.

Title	Function	Adjustment range	Default setting
<i>F6 15</i>	Over-torque trip/alarm selection	0: Alarm only 1: Tripping	0
<i>F6 16</i>	Over-torque detection level	0-250 (%)	150
<i>F6 18</i>	Over-torque detection time	0.0-10.0 [sec]	0.5
<i>F6 19</i>	Over-torque detection level hysteresis	0-100 (%)	10

<Example of operation>

1) Output terminal function: 12 (OT) Over-torque detection

$F615 = 0$  (Alarm only)

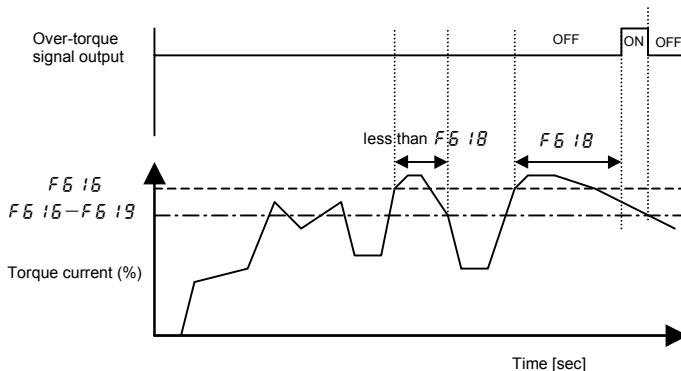

When  $F615 = 1$  (tripping), the inverter will trip if over-torque lasts for the period of time set with  $F618$ . In such a case, the over-torque signal remains ON.

2) Output terminal function: 20 (POT) Over-torque detection pre-alarm

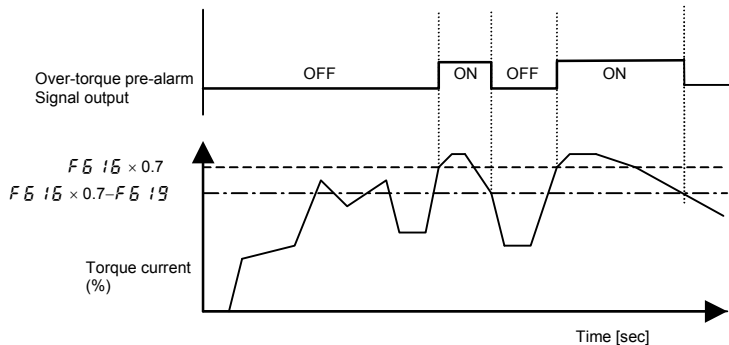

## 6.19.10 Cumulative operation time alarm setting

**F621**: Cumulative operation time alarm setting

- **Function**  
This parameter allows you to set the inverter so that it will put out an alarm signal after a lapse of the cumulative operation time set with  $F521$ .
- \* "0.1" displayed on the monitor refers to 10 hours, and therefore "1" denotes 100 hours.  
Ex.: 38.5 displayed on the monitor = 3850 (hours)

Title	Function	Adjustment range	Default setting
$F521$	Cumulative operation time alarm setting	0.0-9.999	610.0

- **Setting of output signal I**  
Ex.: When assigning the cumulative operation alarm signal output function to the OUT terminal

Title	Function	Adjustment range	Setting
$F131$	Output terminal selection 2A (OUT-NO)	0-255	42 (negative logic 43)

## 6.19.11 Over-voltage stall protection level

$F526$ : Over-voltage stall protection level

\* For more details, see 6.13.5.

6

## 6.19.12 Undervoltage trip

$F527$ : Undervoltage trip/alarm selection

- **Function**  
This parameter is used for selecting the control mode when an undervoltage is detected. Trip information is displayed as "UP I".

$F527=0$ : The inverter is stopped. However, it is not tripped (Failure signal FL not activated).

The inverter is stopped when the voltage does not exceed 60 % or less of its rating.

$F527=1$ : Inverter is stopped. It is also tripped (Failure signal FL activated), only after detection of a voltage not exceeding 60% or less of its rating.

$F527=2$ : Inverter is stopped. However, it is not tripped (Failure signal FL not activated). The inverter stop (Failure signal FL not activated.), only after detection of a voltage not exceeding 50% of its rating.

Be sure to connect the DC reactor specified in 10.4.

Title	Function	Adjustment range	Default setting
$F527$	Undervoltage trip/alarm selection	0: Alarm only (detection level below 60%) 1: Tripping (detection level below 60%) 2: Alarm only (detection level below 50%, DC reactor needed)	0

### 6.19.13 Trip at VIA low level input mode

**F633**: Trip at VIA low level input mode

- Function  
The inverter will trip if the VIA value remains below the specified value for about 0.3 seconds. In such a case, "E - 1B" is displayed.

F633=0: Disabled .....The detection function is disabled.

F633=1-100 .....The inverter will trip if the VIA value remains below the specified value for about 0.3 seconds.

Title	Function	Adjustment range	Default setting
F633	Trip at VIA low level input mode	0: Disabled 1-100%	0

Note : The VIA input value may be judged earlier to be abnormal, depending on the degree of deviation of the analog data detected.

### 6.19.14 Parts replacement alarms

**F634**: Annual average ambient temperature (Parts replacement alarms)

- Function  
You can set the inverter so that it will calculate the remaining useful lives of the cooling fan, main circuit capacitor and on-board capacitor from the ON time of the inverter, the operating time of the motor, the output current (load factor) and the setting of F634, and that it will display and send out an alarm through output terminals when each component is approaching the time of replacement.

Title	Function	Adjustment range	Default setting
F634	Annual average ambient temperature (parts replacement alarms)	1: -10 to +10°C 2: 11-20°C 3: 21-30°C 4: 31-40°C 5: 41-50°C 6: 51-60°C	3

- ★ Display of part replacement alarm information  
Part replacement alarm information (See page H-3) in the Status monitor mode allows you to check on the time of replacement.

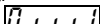
An example of display: 

- ★ Output of part replacement alarm signal  
Assign the part replacement alarm function (function No. 44 or 45. See page K-20) to an output terminal.  
An example of setting: To assign the function to the RY-RC terminal

F130=44

Note 1: Using F634, enter the annual average temperature around the inverter. Be careful not to enter the annual highest temperature.

Note 2: Set F634 at the time of installation of the inverter, and do not change its setting after the start of use. Changing the setting may cause parts replacement alarm calculation error.

## 6.20 Adjustment parameters

### 6.20.1 Pulse train output for meters

**F559**: Logic output/pulse train output selection (OUT-NO)

**F576**: Pulse train output function selection (OUT-NO)

**F577**: Maximum numbers of pulse train

- Function

Pulse trains can be sent out through the OUT-NO output terminals.

To do so, it is necessary to select a pulse output mode and specify the number of pulses.

Ex.: When operations frequencies (0 to 60Hz) are put out by means of 0 to 600 pulses

$FH=60.0$ ,  $F559=1$ ,  $F576=0$ ,  $F577=600$

Title	Function	Adjustment range	Reference of max. value	Default setting
<b>F559</b>	Logic output/pulse train output selection (OUT-NO)	0: Logic output 1: Pulse train output	—	0
<b>F576</b>	Pulse train output function selection (OUT-NO)	0: Output frequency 1: Output current 2: Set frequency 3: DC voltage 4: Output voltage command value 5: Input power 6: Output power 7: Torque 8: Torque current 9: Motor cumulative load factor 10: Inverter cumulative load factor 11: PBR (braking reactor) cumulative load factor 12: Frequency setting value (after PID) 13: VIA Input value 14: VIB Input value 15: Fixed output 1 (Output current: 100%) 16: Fixed output 2 (Output current: 50%) 17: Fixed output 3 (Other than the output current: 100%)	$FH$ 185% $FH$ 150% 150% 185% 185% 250% 250% 100% 100% 100% $FH$ 10V/20mA 10V 185% 185% 100%	0
<b>F577</b>	Maximum numbers of pulse train	500-1600 (pps)	—	800

Note 1: When item of **F576** reaches "Reference of max. value", the number of pulse train set by **F577** are sent to output terminals (OUT-NO)

Note 2: The ON pulse width is maintained constant.

The ON pulse width is fixed at a width that causes the duty to reach 50% at the maximum pulse number set with **F577**.

Therefore, the duty is variable.

For example, the ON pulse width is approximately 0.6 ms when  $F577=800$ , approximately 0.5 ms when  $F577=1000$ , or approximately 0.3 ms when  $F577=1600$ .

Note 3: The minimum pulse output rate is 38 pps. Keep in mind that no pulses can be put out at any rate smaller than 38 pps.

## 6.20.2 Calibration of analog outputs

**F691**: Inclination characteristic of analog output

**F692**: Bias of analog output

- Function  
Output signals from FM terminals are analog voltage signals. Their standard setting range is from 0 to 7.5Vdc.  
Using the FM slide switch in the inverter, you can switch to 0-20mA output. Also, using these parameters, you can calibrate the output to 4-20mA or 20-4mA.

Title	Function	Adjustment range	Default setting
<b>F691</b>	Inclination characteristic of analog output	0: Negative inclination (downward slope) 1: Positive inclination (upward slope)	1
<b>F692</b>	Bias of analog output	0-100%	0

Note: To switch to 0-20mA (4-20mA), turn the FM slide switch to the I position.

### ■ Example of setting

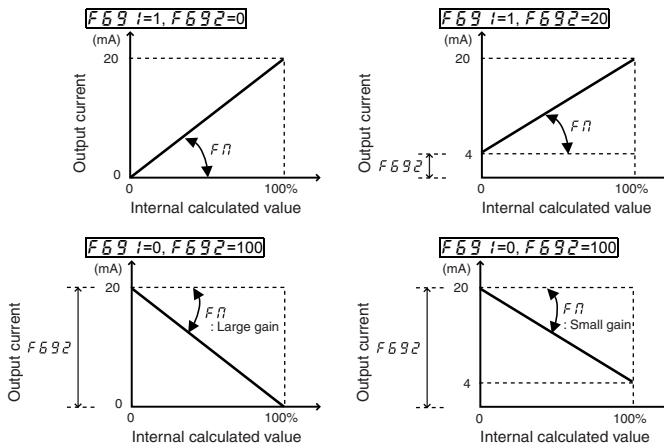

☆ The analog output inclination can be adjusted using the parameter  $F\bar{n}$ .

## 6.21 Operation panel parameter

### 6.21.1 Prohibition of key operations and parameter settings

**F700**: Prohibition of change of parameter setting

**F730**: Prohibition of panel operation (FC)

**F733**: Prohibition of panel operation (RUN/STOP keys)

**F734**: Prohibition of panel emergency stop operation

**F735**: Prohibition of panel reset operation

**F736**: Prohibition of change of  $CNOd/FNOd$  during operation

- Function

These parameters allow you to prohibit the operation of the RUN and STOP keys on the operation panel and the change of parameters. Using these parameters, you can also prohibit various key operations.

[Parameter setting]

Title	Function	Adjustment range	Default setting
<b>F700</b>	Prohibition of change of parameter setting	0: Permitted, 1: Prohibited	0
<b>F730</b>	Panel operation prohibition (FC)	0: Permitted, 1: Prohibited	0
<b>F733</b>	Prohibition of panel operation (RUN/STOP keys)	0: Permitted, 1: Prohibited	0
<b>F734</b>	Prohibition of panel emergency stop operation	0: Permitted, 1: Prohibited	0
<b>F735</b>	Prohibition of panel reset operation	0: Permitted, 1: Prohibited	0
<b>F736</b>	Prohibition of change of $CNOd/FNOd$ during operation	0: Permitted, 1: Prohibited	1

#### ■ Resetting method

Only the **F700** parameter is designed so that its setting can be modified even if 1 (prohibited) is selected.

## 6.21.2 Changing the display unit to A/V/min<sup>-1</sup>

**F 7 0 1**: Current/voltage display mode

- Function  
These parameters are used to change the unit of monitor display.  
% ↔ A (ampere)/V (volt)

### ■ Example of setting

During the operation of the VFS11-2037PM (rated current: 17.5A) at the rated load (100% load), units are displayed as follows:

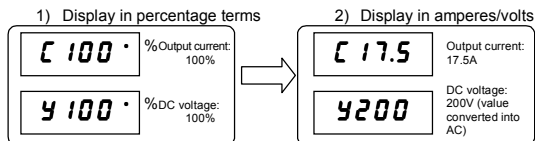

Title	Function	Adjustment range	Default setting
<b>F 7 0 1</b>	Current/voltage display mode	0: % 1: A (ampere)/V (volt)	0

\* The **F 7 0 1** converts the following parameter settings:

- A display Current monitor display
  - Motor electronic-thermal protection level 1 and 2  
*L H r , F 1 7 3*
  - DC braking current  
*F 2 5 1*
  - Stall prevention level 1 and 2  
*F 6 0 1 , F 1 8 5*
  - Small current detection current  
*F 6 1 1*
  - Step-out detection current level  
*F 9 1 0*  
(for PM motors)
- V display Voltage monitor display

Note) Base frequency voltage 1 and 2 (*U L U , F 1 7 1*)s always displayed in the unit of V.

### 6.21.3 Displaying the rotational speed of the motor or the line speed

**F702**: Frequency free unit magnification

**F705**: Inclination characteristic of free unit display

**F706**: Bias of free unit display

- Function  
The frequency or any other item displayed on the monitor can be converted freely into the rotational speed of the motor, the operating speed of the load, and so on.

The value obtained by multiplying the displayed frequency by the **F702**-set value will be displayed as follows:

$$\text{Value displayed} = \text{Monitor-displayed or parameter-set frequency} \times \text{F702}$$

- 1) Displaying the motor speed

To switch the display mode from 60Hz (default setting) to  $1800\text{min}^{-1}$  (the rotating speed of the 4P motor)

$$\begin{array}{ccc} \boxed{60.0} \text{ Hz} & \longrightarrow & \boxed{1800} \\ \text{F702}=0.00 & & \begin{array}{l} \text{F702}=30.00 \\ 60 \times 30.00 = 1800 \end{array} \end{array}$$

- 2) Displaying the speed of the loading unit

To switch the display mode from 60Hz (default setting) to  $6\text{m/min}^{-1}$  (the speed of the conveyer)

$$\begin{array}{ccc} \boxed{60.0} \text{ Hz} & \longrightarrow & \boxed{6.0} \\ \text{F702}=0.00 & & \begin{array}{l} \text{F702}=0.10 \\ 60 \times 0.10 = 6.0 \end{array} \end{array}$$

Note: This parameter displays the inverter output frequency as the value obtained by multiplying it by a positive number. This does not mean that the actual motor speed or line speed are indicated with accuracy.

Title	Function	Adjustment range	Default setting
<i>F 702</i>	Frequency free unit magnification	0.00: Free unit display disabled (display of frequency) 0.01-200.0	0.00
<i>F 705</i>	Inclination characteristic of free unit display	0: Negative inclination (downward slope) 1: Positive inclination (upward slope)	1
<i>F 706</i>	Bias of free unit display	0.00- <i>FH</i>	0.00

\* The *F 702* to *F 706* converts the following parameter settings:

- Free unit Frequency monitor display      Operation frequency command, Operation frequency, PID feedback, Frequency command value (PID-computed), Operation frequency command at trip

Frequency-related parameters

*FH, UL, LL, Sr 1-5r 7, F 100, F 101, F 102, F 167, F 202, F 204, F 211, F 213, F 240, F 241, F 242, F 250, F 260, F 265, F 267, F 268, F 270-F 275, F 287-F 294, F 343, F 345, F 505, F 513, F 812, F 814*

■ An example of setting when *FH* is 80 and *F 702* is 10.00

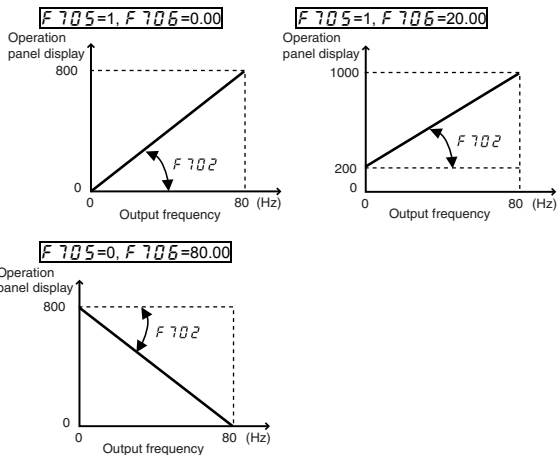

## 6.21.4 Changing the steps in which the value displayed changes

**F707**: Free step 1 (pressing a panel key once)

**F708**: Free step 2 (panel display)

- Function

These parameters are used to specify steps in which the command value or standard monitor output frequency displayed on the panel changes each time you press the up or down key to set a frequency on the operation panel.

Note 1: The settings of these parameters have no effect when the free unit selection (**F702**) is enabled.

Note 2: If you press the Up key on the panel repeatedly to increase the frequency while **F707** is set to any value other than 0, the "HI" alarm will appear immediately before the frequency exceeds the **FH** (maximum frequency) and the frequency will stop increasing. Similarly, if you press the Down key on the panel repeatedly to decrease the frequency, the "LO" alarm will appear immediately before the frequency decreases below the **LL** (lower-limit frequency) and the frequency will stop decreasing.

### ■ When **F707** is not 0.00, and **F708** is not 0 (disabled)

Under normal conditions, the frequency command value from the operation panel increases in steps of 0.1 Hz each time you press the  $\blacktriangle$  key. If **F707** is not 0.00, the frequency command value will increase by the value with **F707** each time you press the  $\blacktriangle$  key. Similarly, it will decrease by the value set with **F707** each time you press the  $\blacktriangledown$  key.

In this case, the output frequency displayed in standard monitor mode changes in steps of 0.1 Hz, as usual.

### ■ When **F707** is not 0.00, and **F708** is not 0 (disabled)

The value displayed on the panel also can also be changed in steps.

$$\boxed{\text{Output frequency displayed in standard monitor mode}} = \boxed{\text{Internal output frequency}} \times \frac{\mathbf{F708}}{\mathbf{F707}}$$

Title	Function	Adjustment range	Default setting
<b>F707</b>	Free step 1 (pressing a panel key once)	0.00: Disabled 0.01- <b>FH</b> (Hz)	0.00
<b>F708</b>	Free step 2 (panel display)	0: Disabled 1-255	0

### ■ Example of setting 1

When **F707**=10.00 (Hz):

The frequency (**FL**) set on the operation panel changes in steps of 10.0 Hz: 0.0 → 20.0 → ... 60.0 (Hz), each time you press the  $\blacktriangle$  key. This function comes in very handy when operating the load at limited frequencies that change in steps of 1Hz, 5Hz, 10Hz, and so on.

### ■ Example of setting 2

When  $F 7 7 = 1.00$  (Hz), and  $F 7 8 = 1$ :

Each time you press the  $\Delta$  key, the frequency setting  $F \square$  changes in steps of 1Hz:  $0 \rightarrow 1 \rightarrow 2 \rightarrow \dots \rightarrow 60$  (Hz) and also the value displayed on the operation panel changes in steps of 1. Use these settings to hide decimal fractions and also the value displayed on the operation panel changes in steps of 1. Use these settings to hide decimal fractions.

## 6.21.5 Changing the item displayed by default

$F 7 1 0$ : Standard monitor display selection

- Function  
This parameter specifies display format while power is on.

### ■ Changing the display format while power is on

When the power is on, the standard monitor mode displays the operation frequency (default setting) in the format of "0.0" or "0.FF". This format can be changed to any other monitor display format by setting  $F 7 1 0$ . This new format, however, will not display an assigned prefix such as  $\xi$  or  $\zeta$ .

#### ■ Parameter setting

Title	Function	Adjustment range	Default setting
$F 7 1 0$	Standard monitor display selection	0: Operation frequency (Hz/free unit/step) 1: Frequency command (Hz/free unit/step) 2: Output current (%A) 3: Inverter rated current (A) 4: Inverter load factor (%) 5: Output power (kW) 6: Frequency command after PID control (Hz/free unit/step) 7: Optional item specified from an external control unit	0

- \* For more information on the  $F 7 1 0$  option "7," refer to "Communications Function Instruction Manual."

## 6.21.6 Canceling the operation command

**F719**: Canceling of operation command when standby terminal (ST) is turned off

- Function  
When the standby (ST) terminal is turned off during panel operation, the inverter will restart operation if the ST terminal is turned back on. Using this parameter, you can also set the inverter so that, even if the ST is turned back on, it will not restart operation until you press the RUN key.

Title	Function	Adjustment range	Default setting
F719	Canceling of operation command when standby terminal (ST) is turned off	0: Operation command canceled (cleared) 1: Operation command retained	1

## 6.21.7 Selection of operation panel stop pattern

**F721**: Selection of operation panel stop pattern

- Function  
This parameter are used to select a mode in which the motor started by pressing the (RUN) key on the operation panel is stopped when the (STOP) key is pressed.

- Slowdown stop  
The motor slows down to a stop in the deceleration time set with  $dEC$  (or  $F501$  or  $F511$ ).
- Coast stop  
The inverter cuts off power supply to the motor. The motor comes to a stop after coasting for a while by inertia. Depending on the load, the motor may keep running for a good long time.

[Parameter setting]

Title	Function	Adjustment range	Default setting
F721	Selection of operation panel stop pattern	0: Slowdown stop 1: Coast stop	0

## 6.22 Communication function (Common serial)

### 6.22.1 Setting of common function

<b>F800</b> : Communication rate	<b>F829</b> : Selection of communication protocol
<b>F801</b> : Parity	<b>F870</b> : Block write data 1
<b>F802</b> : Inverter number	<b>F871</b> : Block write data 2
<b>F803</b> : Communication error trip time	<b>F875</b> : Block read data 1
<b>F805</b> : Communication waiting time	<b>F876</b> : Block read data 2
<b>F806</b> : Setting of master and slave for communication between inverters	<b>F877</b> : Block read data 3
<b>F811</b> : Communication command point 1 setting	<b>F878</b> : Block read data 4
<b>F812</b> : Communication command point 1 frequency	<b>F879</b> : Block read data 5
<b>F813</b> : Communication command point 2 setting	<b>F880</b> : Free notes
<b>F814</b> : Communication command point 2 frequency	

- Function  
Function The VFS11 Series allows a data communication network to be constructed for exchanging data between a host computer or controller (referred to collectively as the computer) and the inverter by connecting an optional RS232C or RS485 communication conversion unit.
- <Computer-linking functions>  
The following functions are enabled by data communication between the computer and inverter
  - (1) Monitoring inverter status (such as the output frequency, current, and voltage)
  - (2) Sending RUN, STOP and other control commands to the inverter
  - (3) Reading, editing and writing inverter parameter settings
- <RS232C communication>  
Data can be exchanged between one computer and one inverter.
- <RS485 communication>  
Data can be exchanged between the computer and each of the inverters connected.

★ The following are available as common serial optional units:

- RS232C communications conversion cable (Model: RS20035)
  - RS485 communication conversion unit with terminal board (Model: RS4001Z, RS4002Z)  
Communication cable (Model: CAB0011 (1m), CAB0013 (3m), CAB0015 (5m))
  - Internal RS485 communication circuit board ( Model: RS4003Z)
  - Internal DeviceNet communication circuit board ( Model: DEV001Z)
  - Internal LONWORKS communication circuit board ( Model: LIU005Z)
- These internal products require no interconnect cables, because of built-in type.

## ■ Communication function parameters (Common serial options)

The data transfer speed, parity type, inverter number, and communication error trip time can be set/edited by operation panel operation or communication function.

Title	Function	Adjustment range	Default setting
<i>F800</i>	Communication rate	0: 1200bps 1: 2400bps 2: 4800bps 3: 9600bps 4: 19200bps	3
<i>F801</i>	Parity	0: NON (No parity) 1: EVEN (Even parity) 2: ODD (Odd parity)	1
<i>F802</i>	Inverter number	0-255	0
<i>F803</i>	Communication error trip time	0: Disabled (*) 1-100 (s)	0
<i>F805</i>	Communication waiting time	0.00: Regular communication 0.01-2.00 (s)	0.00
<i>F806</i>	Setting of master and slave for communication between inverters	0: Slave (0 Hz command issued in case the master inverter fails) 1: Slave (Operation continued in case the master inverter fails) 2: Slave (Emergency stop tripping in case the master inverter fails) 3: Master (transmission of frequency commands) 4: Master (transmission of output frequency signals)	0
<i>F811</i>	Communication command point 1 setting	0-100 (%)	0
<i>F812</i>	Communication command point 1 frequency	0-500.0 (Hz)	0.0
<i>F813</i>	Communication command point 2 setting	0-100 (%)	100
<i>F814</i>	Communication command point 2 frequency	0-500.0 (Hz)	50.0 (WP type) 60.0 (WN, AN type)
<i>F829</i>	Selection of communication protocol	0: Toshiba inverter protocol 1: ModbusRTU protocol	0
<i>F870</i>	Block write data 1	0: No selection 1: Command 1 2: Command 2 3: Frequency command	0
<i>F871</i>	Block write data 2	4: Output data on the terminal board 5: Analog output for communications	0

Title	Function	Adjustment range	Default setting
<i>F B 7 5</i>	Block read data 1	0: No selection 1: Status information	0
<i>F B 7 6</i>	Block read data 2	2: Output frequency 3: Output current	0
<i>F B 7 7</i>	Block read data 3	4: Output voltage 5: Alarm information	0
<i>F B 7 8</i>	Block read data 4	6: PID feedback value 7: Input terminal board monitor	0
<i>F B 7 9</i>	Block read data 5	8: Output terminal board monitor 9: VIA terminal board monitor	0
<i>F B 8 0</i>	Free notes	10: VIA terminal board monitor 0-65535	0

\* Disabled..... Indicates that the inverter will not be tripped even if a communication error occurs.

Trip ..... The inverter trips when a communication time-over occurs.

In this case a trip information  $\varepsilon r r 5$  flashes on and off on the operation panel.

## 6.22.2 Using the RS232C/RS485

### ■ Setting the communication functions

Setting commands and frequencies by communications has priority over sending commands from the operation panel or the terminal board. Command/frequency setting by communications can therefore be enabled, irrespective of the setting in the command mode ( $\mathcal{L} n d d$ ) or the frequency setting mode ( $F n d d$ ).

When inverters are connected to each others, however, in order for slave inverters to recognize frequency signals from the master inverter as frequency commands, the frequency setting mode selection 1 parameter ( $F n d d$ ) provided for each slave inverter needs to be set to 4 (serial communications). Refer to the COMMUNICATIONS EQUIPMENT USER'S MANUAL for details.

However, when the input terminal function selection parameter is set to 48: SC/LC (Serial/Local selection), the inverter can be operated with the settings of the command mode ( $\mathcal{L} n d d$ ) or the frequency setting mode ( $F n d d$ ) by external input.

### ■ Transmission specifications

Item	Specifications
Transmission scheme	Half-duplex
Connection scheme	Centralized control
Synchronization scheme	Asynchronous
Transmission rate	Default: 9600 baud (parameter setting) Option: Either 1200, 2400, 4800, 9600, or 19200baud
Character transmission	ASCII code: JIS X 0201 8, 8-bit (fixed) Binary code: Binary, 8-bit (fixed)
Stop bit length	Inverter receiving: 1 bit, Inverter sending: 2 bits
Error detection	Parity: Even, Odd, or None selectable by parameter setting; check sum method
Character transmission format	Receiving: 11-bit, Sending: 12-bit
Order of bit transmission	Least significant bit first
Frame length	Variable to a maximum of 17 bytes

## ■ Example of connection for RS485-communication

<Example of connection>

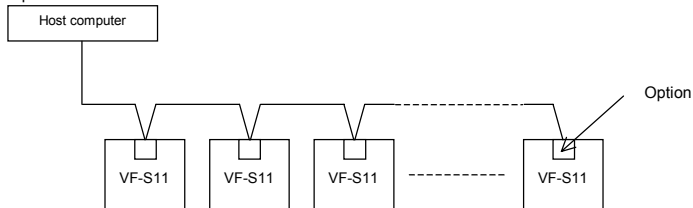

<Independent communication>

Perform computer-inverter connection as follows to send operation frequency commands from the host computer to inverter No. 3:

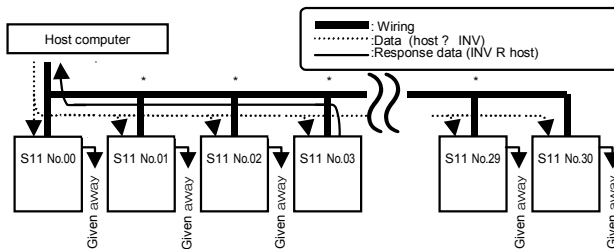

"Given away": Only the inverter with the selected inverter number conducts data processing. All other inverters, even if they have received the data, give it away and stand by to receive the next data.

\* : Use the terminal board to branch the cable.

- (1) Data is sent from the host computer.
- (2) Data from the computer is received at each inverter and the inverter numbers are checked.
- (3) The command is decoded and processed only by the inverter with the selected inverter number.
- (4) The selected inverter responds by sending the processing results, together with its own inverter number, to the host computer.
- (5) As a result, only the selected inverter starts operating in accordance with the operation frequency command by communicating independently.

☆ For details of the communication function, refer to the separate instruction manual, "VF-S11 Serial Communication Function" (E6581156).

Note 1.: Limit the distance between the common serial optional units and the inverter to 5m.

- 2.: Set Data transfer speed to 9600 bps or less if data exchange between RS4001Z and the inverter.

## 6.23 Parameters for options

**F890**: Parameter for option 1

**F891**: Parameter for option 2

**F892**: Parameter for option 3

**F893**: Parameter for option 4

**F894**: Parameter for option 5

These parameters can be used only when specific optional parts are installed. Do not use these parameters unless such parts are installed.

## 6.24 Permanent magnetic motors

**F910**: Step-out detection current level

**F911**: Step-out detection time

**F912**: High-speed torque adjustment coefficient

- Function

If the permanent magnet motor (PM motor) steps out and if the exciting current increases (it increases in such a case) and remains above the value set with **F910** for the period of time set with **F911**, the inverter will judge the motor to be stepping out and trip it. At that time, the trip message "SOUt" is displayed.

Title	Function	Adjustment range	Default setting
<b>F910</b>	Step-out detection current level	10 ~ 150 (%) / (A)	100
<b>F911</b>	Step-out detection time	0.0 ~ 25.0 [sec]	1.0
<b>F912</b>	High-speed torque adjustment coefficient	0.0 ~ 650.0	0.00

Note 1: When using an PM motor, consult your Toshiba dealer, since the inverter is not compatible with all types of PM motors.

Note 2: The inverter may fail to detect step-out in some cases, because it uses an electrical method to detect step-out. To avoid detection failures, you are recommended to install a mechanical step-out detector.

Note 3: There is no need adjust **F912** under normal conditions. (Do not change the setting, unless otherwise instructed by Toshiba technical staff.)

## 7. Applied operation

### 7.1 Setting the operation frequency

Applied operation can be performed by selecting the inverter frequency setting. To make settings for applied operation, use the basic parameter  $F70d$  (selection of frequency setting mode 1), and the extended parameters  $F200$  (frequency priority selection) and  $F207$  (selection of frequency setting mode 2).

(1) Internal potentiometer setting

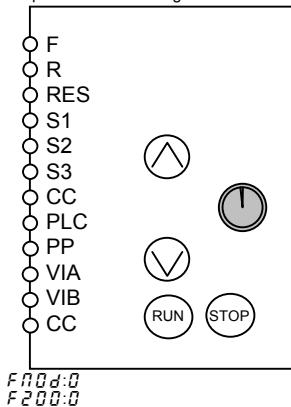

(2) Operation panel key setting

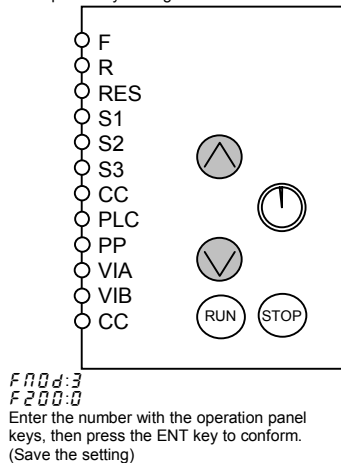

(3) External potentiometer setting

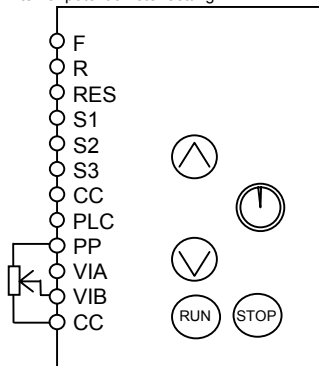

*F A0d: 2*  
*F 200: 0*

Use the parameters *F 2 10* to *F 2 13* for this setting.

(4) Input voltage setting (0 to 10 Vdc)

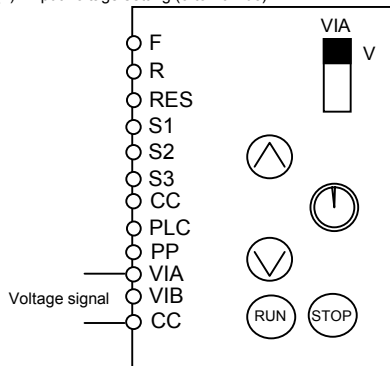

*F A0d: 1*  
*F 200: 0*

Use the parameters *F 20 1* to *F 20 4* for this setting.

(To use VIB, set *F A0d* at 2)

(5) Input current setting (4 to 20 mAcd)

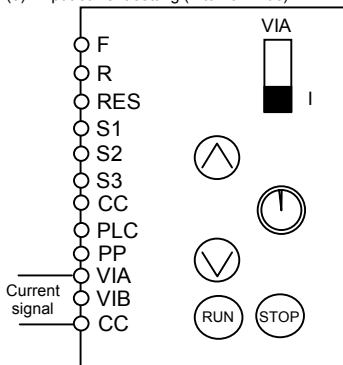

*F A0d: 1*  
*F 200: 0*

Use parameters *F 20 1* to *F 20 4* for this setting.  
(*F 20 1*: 20%)

(6) External contact UP/DOWN

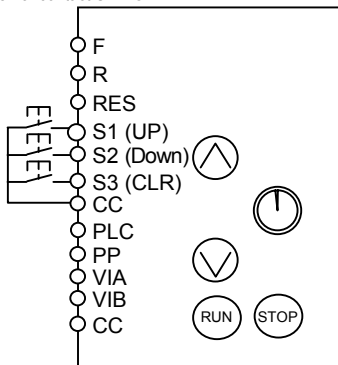

*F A0d: 5, F 200: 0*

Use the parameters *F 25 4* to *F 25 8* for this setting.

To change the frequency when power is off, set *F 25 9: 1* (Rewriting of *F 25 8* when power is turned off.)

*F 1 14: 4 1* (Allocation of UP)

*F 1 15: 4 2* (Allocation of DOWN)

*F 1 16: 4 3* (Allocation of CLR)

(7) Preset-speed

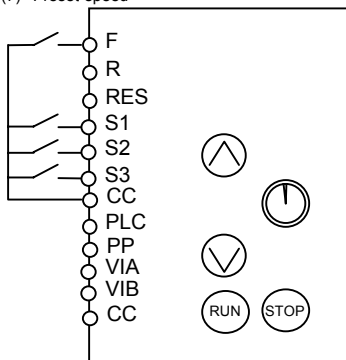

*F200d: 0* (Terminal board)  
*5r 1 to 5r 7: 1-7-speed run*  
*F207 to F294: 8-15-speed run*  
 To select 7-speed run, use the terminals S1 to S3.  
 To select 15-speed run, allocate the input terminal function SS4.

(8a) Voltage/current switching 1

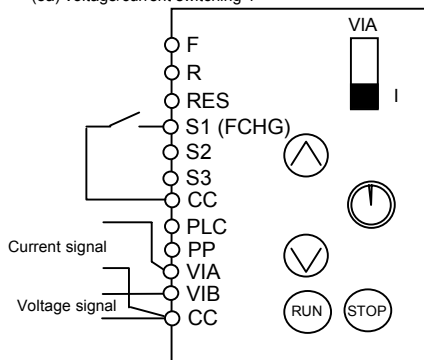

*F200: 0* (Forced switching of FCHG)  
*F114: 30* (Allocation of FCHG)  
*F20d: 2*  
*F207: 1*

(8b) Voltage/current switching 2

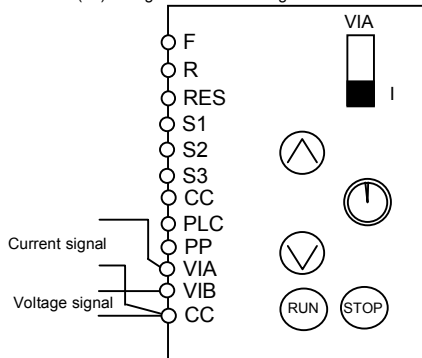

*F200: 1* (Automatic switching)  
*F20d: 2*  
*F207: 1*

(9) Analog addition setting

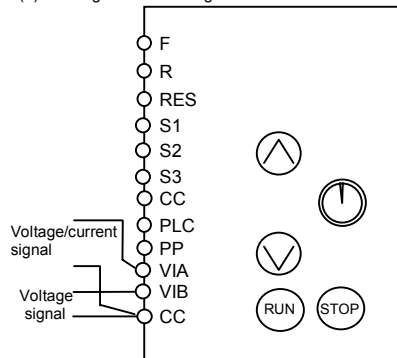

*F20d: 6* (VIA+VIB)  
*F200: 0*

(10) Switching between external contact UP/DOWN and VIA input

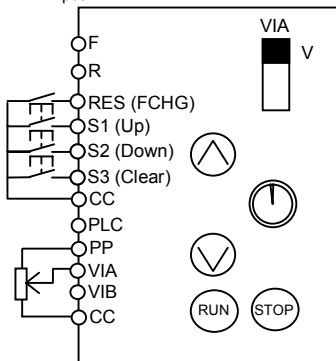

*F 200: 5, F 200: 0, F 207: 1*  
*F 113: 38* (Allocation of FCHG)  
 To switch to VIA setting, enter the command through FCHG.  
*F 114: 41* (Allocation of UP)  
*F 115: 42* (Allocation of DOWN)  
*F 116: 43* (Allocation of CLR)

(11) Switching between analog setting and preset speed setting

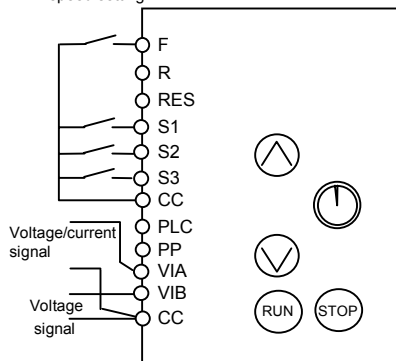

*F 200: 1* (VIA) or *2* (VIB)  
*C 000: 0* (Terminal board)  
*F 200: 0*  
 To switch to preset-speed setting, use the external terminals S1 to S3

(12) Switching between analog setting and terminal setting from the operation panel

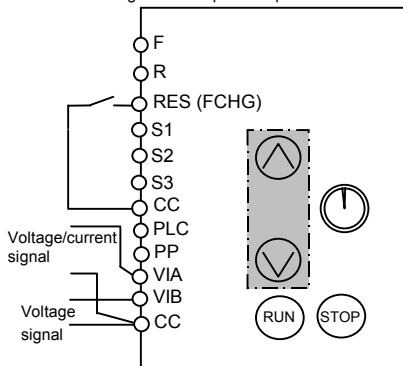

*F 200: 3* (Operation panel)  
*F 113: 38* (Allocation of FCHG)  
 To switch to *F 207* setting, enter the command through FCHG.  
*F 200: 0*  
*F 207: 1*(VIA) or *2* (VIB).

(13) Setting by means of a remote input device

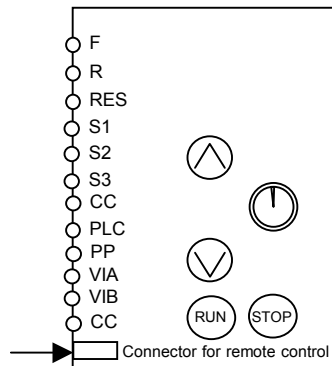

Communication command fa00h 14bit: 1  
 Priority on remote input device  
*(F 207: 4)*

(14) Switching between remote control and local control

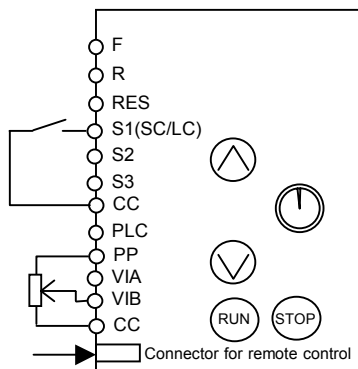

Communication command fa00h 14bit: 1  
*F 1 14: 4B* (Allocation of SL/LC)  
 Switched to local when a command is entered through SC and LC during operation by means of a remote input device  
 Activated if the parameter *F 00 d*, *F 200* or *F 207* is so set

## 7.2 Setting the operation mode

Applied operation can be performed by selecting the operation mode. To set the operation mode, use the basic parameter *LC 00 d* (command mode selection) and the input terminal selection parameter.

(1) Operation panel operation

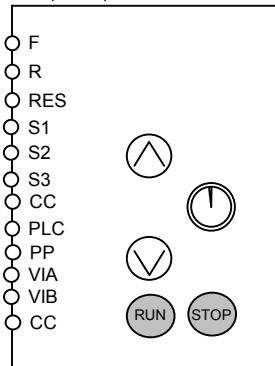

*LC 00 d: 1* (Operation panel)

(2) Terminal board operation

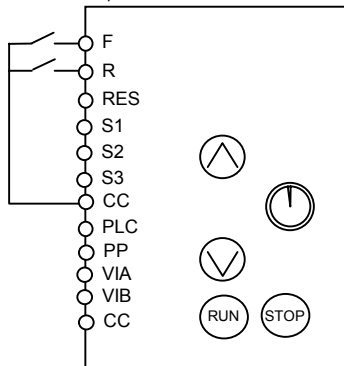

*LC 00 d: 0* (Terminal board)

(3) Operation from an external input device

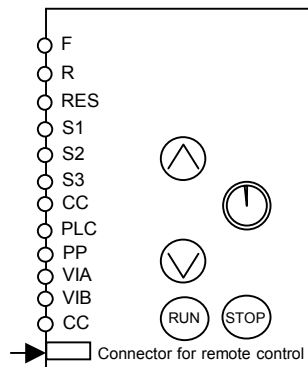

Priority is given to an external input device when the remote command fa00h 15-bit is set at 1.

(4) Switching from an external input device to the terminal board

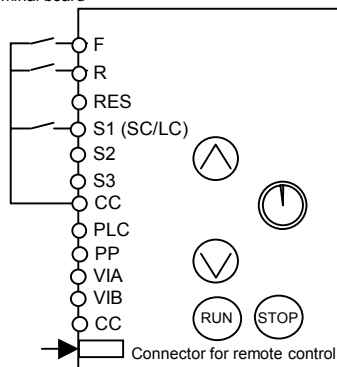

[*Mod*: 0] (Terminal board)  
*F* 1 14: 4B (Allocation of SL/LC)  
 Remote control can be switched forcefully to local control from the external SC/LC by setting the remote command fa00h 15-bit at 1. Operation is controlled from the terminal board.

(5) Switching from the operation panel to the terminal board

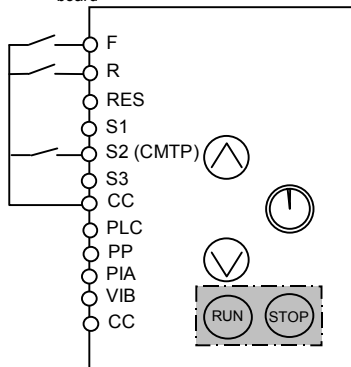

[*Mod*: 1]  
*F* 1 15: 5B (Allocation of CMTMP)  
 To switch to terminal board operation, use the external CMTMP input.

## 8. Monitoring the operation status

Refer to 4.1 about flow of monitor.

### 8.1 Status monitor mode













#### 8.1.1 Status monitor under normal conditions

In this mode, you can monitor the operation status of the inverter.

To display the operation status during normal operation:

Press the  key twice.

Setting procedure (eg. operation at 60Hz)

	Item displayed	Key operated	LED display	Communication No.	Description
			60.0		The operation frequency is displayed (Operation at 60Hz). (When standard monitor display selection <i>F 7 10</i> is set at 0 (operation frequency))
	Parameter setting mode		<i>R U H</i>		The first basic parameter " <i>R U H</i> " (history function) is displayed.
Note 1	Direction of rotation		<i>F r - F</i>	FE01	The direction of rotation is displayed. ( <i>F r - F</i> : forward run, <i>F r - r</i> : reverse run)
	Operation frequency command		<i>F 60.0</i>	FE02	The operation frequency command value (Hz/free unit) is displayed.
Note 2	Load current		<i>ℓ 80</i>	FE03	The inverter output current (load current) (%A) is displayed.
Note 3	Input voltage		<i>Y 100</i>	FE04	The inverter input (DC) voltage (%V) is displayed.
	Output voltage		<i>P 100</i>	FE05	The inverter output voltage (%V) is displayed.
	Torque		<i>9 60</i>	FE18	The torque (%) is displayed.
	Torque current		<i>c 90</i>	FE20	The torque current (%A) is displayed.
	Inverter load factor		<i>ℓ 70</i>	FE27	The inverter load factor (%) is displayed.
	PBR cumulative load factor		<i>r 50</i>	FE25	The cumulative load factor of the braking resistor (%) is displayed.
	Input power		<i>h 80</i>	FE29	The inverter input power (kW) is displayed.
	Output power		<i>H 75</i>	FE30	The inverter output power (kW) is displayed.
	Operation frequency		<i>α 60.0</i>	FD00	The operation frequency (Hz/free unit) is displayed.

(Continued overleaf)

(Continued)

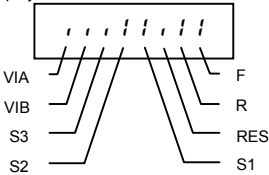
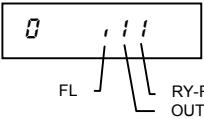
Item displayed	Key operated	LED display	Communication No.	Description
Note 4 Input terminal	▲	.....!!!	FE06	The ON/OFF status of each of the control signal input terminals (F, R, RES, S1, S2, S3, VIB and VIA) is displayed in bits.  ON: ! OFF: . 
Note 5 Output terminal	▲	0 . . . !	FE07	The ON/OFF status of each of the control signal output terminals (RY, OUT and FL) is displayed in bits.  ON: ! OFF: . 
CPU1 version	▲	u 10 !	FE08	The version of the CPU1 is displayed.
CPU2 version	▲	u c 0 !	FE73	The version of the CPU2 is displayed.
Memory version	▲	u E 0 !	FE09	The version of the memory mounted is displayed.
PID feedback	▲	d 5 0	FE22	The PID feedback value is displayed. (Hz/free unit)
Frequency command value (PID-computed)	▲ ▲ ▲	b 7 0	FE15	The PID-computed frequency command value is displayed. (Hz/free unit)
Note 6 Integral input power	▲	h 8 5	FE76	The integrated amount of power (kWh) supplied to the inverter is displayed. (0.01=1kWh, 1.00=100kWh)
Note 6 Integral output power	▲	H 7 5	FE77	The integrated amount of power (kWh) supplied from the inverter is displayed. (0.01=1kWh, 1.00=100kWh)
Rated current	▲	R 1 6.5	FE70	The rated current of the inverter (A) is displayed.
Note 7 Past trip 1	▲	0 C 3 ⇔ !	FE10	Past trip 1 (displayed alternately)
Note 7 Past trip 2	▲	0 H ⇔ 2	FE11	Past trip 2 (displayed alternately)
Note 7 Past trip 3	▲	0 P 3 ⇔ 3	FE12	Past trip 3 (displayed alternately)

(Continued overleaf)

(Continued)

	Item displayed	Key operated	LED display	Communication No.	Description
Note 7	Past trip 4		$n E r r \rightarrow 4$	FE13	Past trip 4 (displayed alternately)
Note 8	Parts replacement alarm information		$n . . . . !$	FE79	<p>The ON/OFF status of each of the cooling fan, circuit board capacitor, main circuit capacitor of parts replacement alarm or cumulative operation time are displayed in bits.</p> <p>ON: ! OFF: .</p> <p>Cumulative operation time      Cooling fan Control circuit board capacitor Main circuit capacitor</p>
Note 9	Cumulative operation time		$t 0 . 1 0$	FE14	The cumulative operation time is displayed. (0.01=1 hour, 1.00=100 hours)
	Default display mode		$6 0 . 0$		The operation frequency is displayed (Operation at 60Hz).

## 8.1.2 Display of detailed information on a past trip

Details on a past trip (of trips 1 to 4) can be displayed, as shown in the table below, by pressing the **ENT** key when the trip record is selected in the status monitor mode.

Unlike the "Display of detailed trip information at the occurrence of a trip" in 8.2.2, details on a past trip can be displayed, even after the inverter is turned off or reset.

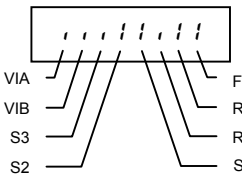
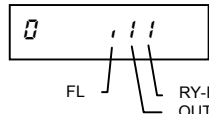
	Item displayed	Key operated	LED display	Description
Note 11	Past trip 1		$0 \text{ C } 1 \leftrightarrow 1$	Past trip 1 (displayed alternately)
	Continuous trips	<b>ENT</b>	$n \ 2$	The number of time the same trip occurred in succession is displayed. (Unit: times)
Note 1	Operation frequency	<b>▲</b>	$0 \ 6 \ 0 \ 0$	The operation frequency when the trip occurred is displayed.
	Direction of rotation	<b>▲</b>	$F \ r - F$	The direction of rotation when the trip occurred is displayed. ( $F \ r - F$ : Forward run, $F \ r - r$ : Reverse run)
	Operation frequency command	<b>▲</b>	$F \ 8 \ 0 \ 0$	The operation command value when the trip occurred is displayed.
Note 2	Load current	<b>▲</b>	$C \ 1 \ 5 \ 0$	The inverter output current when the trip occurred is displayed. (%/A)
Note 3	Input voltage	<b>▲</b>	$4 \ 1 \ 2 \ 0$	The inverter input voltage (DC) when the trip occurred is displayed. (%/V).
	Output voltage	<b>▲</b>	$P \ 1 \ 0 \ 0$	The inverter output voltage when the trip occurred is displayed. (%/V)
Note 4	Input terminal	<b>▲</b>	$... \ . \ . \ . \ . \ . \ . \ . \ .$	The ON/OFF statuses of the control input terminals (F, R, RES, S1, S2, S3, VIB and VIA) are displayed in bits. ON: $\cdot$ OFF: $\cdot$ 
Note 5	Output terminal	<b>▲</b>	$0 \ . \ . \ .$	The ON/OFF statuses of the control output terminals (RY, OUT and FL) are displayed in bits. ON: $\cdot$ OFF: $\cdot$ 
Note 9	Cumulative operation time	<b>▲</b>	$t \ 8 \ . \ 5 \ 6$	The cumulative operation time when the trip occurred is displayed. (0.01=1 hour, 1.00=100 hours)
	Past trip 1	<b>MODE</b>	$0 \text{ C } 1 \leftrightarrow 1$	Press this key to return to past trip 1.

## 8.2 Display of trip information

### 8.2.1 Trip code display

If the inverter trips, an error code is displayed to suggest the cause. Since trip records are retained, information on each trip can be displayed anytime in the status monitor mode.

#### ■ Display of trip information

Error code	Failure code	Description
$nErr(*)$	0000	No error
$OC1$	0001	Overcurrent during acceleration
$OC2$	0002	Overcurrent during deceleration
$OC3$	0003	Overcurrent during constant speed operation
$OCL$	0004	Load-side overcurrent during start-up
$OCR$	0005	Armature-side overcurrent during start-up
$EPH1$	0008	Input phase failure or exhaustion of main circuit capacitor
$EPH0$	0009	Output phase failure
$OP1$	000A	Overvoltage during acceleration
$OP2$	000B	Overvoltage during deceleration
$OP3$	000C	Overvoltage during constant-speed operation
$OL1$	000D	Inverter overload trip
$OL2$	000E	Motor overload trip
$OLr$	000F	Dynamic braking register overload trip
$OH$	0010	Overheating trip or thermal detector failure
$E$	0011	Emergency stop
$EEP1$	0012	E <sup>2</sup> PROM fault 1 (writing error)
$EEP2$	0013	E <sup>2</sup> PROM fault 2 (initialization error) or power-off during the setting of $t_{UP}$
$EEP3$	0014	E <sup>2</sup> PROM fault 3 (reading error)
$Err2$	0015	Inverter RAM fault
$Err3$	0016	Inverter ROM fault
$Err4$	0017	CPU fault trip 1
$Err5$	0018	Communication error
$Err7$	001A	Current defector fault
$Err8$	001B	Optional circuit board format error
$UC$	001D	Small-current trip
$UP1$	001E	Undervoltage trip
$Ut$	0020	Over-torque trip
$EF2$	0022	Ground fault

(Continued overleaf)

(Continued)

Error code	Failure code	Description
$OC1P$	0025	Overcurrent flowing in element during acceleration
$OC2P$	0026	Overcurrent flowing in element during deceleration
$OC3P$	0027	Overcurrent flowing in element during constant-speed operation
$Et n 1$	0054	Auto-tuning error
$Et 4P$	0029	Inverter type error
$EH2$	002E	External thermal input
$E-18$	0032	VIA cable break
$E-19$	0033	Communication error between CPUs
$E-20$	0034	V/F control error
$E-21$	0035	CPU fault 2
$SGU2$	002F	Step-out (for PM motors only)

(Note) Past trip records (trip records retained or trips that occurred in the past) can be called up.

(Refer to 8.1 "Status monitor mode" for the call-up procedure.)







(\*) Strictly speaking, this code is not an error code; this code is displayed to show the absence of error when the past trip monitor mode is selected.

## 8.2.2 Display of trip information at the occurrence of a trip

At the occurrence of a trip, the same information as that displayed in the mode described in 8.1.1, "Status monitor under normal conditions," can be displayed, as shown in the table below, if the inverter is not turned off or reset.

To display trip information after turning off or resetting the inverter, follow the steps described in 8.1.2, "Display of detailed information on a past trip."

### Example of call-up of trip information

Item displayed	Key operated	LED display	Communication No.	Description
Cause of trip		$OP2$	/	Status monitor mode (The code blinks if a trip occurs.) The motor coasts and comes to a stop (coast stop).
Parameter setting mode		$RUH$		The first basic parameter " $RUH$ " (history function) is displayed.
Direction of rotation		$F r - F$	FE01	The direction of rotation at the occurrence of a trip is displayed. ( $F r - F$ : forward run, $F r - r$ : reverser run).
Operation frequency command		$F50.0$	FE02	The operation frequency command value (Hz/free unit) at the occurrence of a trip is displayed.
Load current		$L130$	FE03	The output power of the inverter at the occurrence of a trip (%A) is displayed.
Input voltage		$U141$	FE04	The inverter input (DC) voltage (%V) at the occurrence of a trip is displayed.
Output voltage		$P100$	FE05	The output voltage of the inverter at the occurrence of a trip (%V) is displayed.

(Continued overleaf)

(Continued)

Item displayed	Key operated	LED display	Communication No.	Description
Torque	▲	q 60	FE18	The torque at the occurrence of a trip (%) is displayed.
Torque current	▲	c 90	FE20	The torque current (%/A) at the occurrence of a trip is displayed.
Inverter load factor	▲	t 70	FE27	The inverter load factor (%) at the occurrence of a trip is displayed.
PBR cumulative load factor	▲	r 50	FE25	The cumulative load factor (%) of the resistor at the occurrence of a trip is displayed.
Input power	▲	h 80	FE29	The inverter input power (kW) at the occurrence of a trip is displayed.
Output power	▲	H 75	FE30	The inverter output power (kW) at the occurrence of a trip is displayed.
Operation frequency	▲	o 60.0	FE00	The inverter output frequency (Hz/free unit) at the occurrence of a trip is displayed.
Note 4 Input terminal	▲	.....	FE06	The ON/OFF statuses of the control input terminals (F, R, RES, S1, S2, S3, VIB and VIA) are displayed in bits. 
Note 5 Output terminal	▲	0 . . .	FE07	The ON/OFF status of each of the control signal output terminals (RY, OUT and FL) at the occurrence of a trip is displayed in bits. 
CPU1 version	▲	u 10 1	FE08	The version of the CPU1 is displayed.
CPU2 version	▲	u c 0 1	FE73	The version of the CPU2 is displayed.
Memory version	▲	u E 0 1	FE09	The version of the memory mounted is displayed.
PID feedback	▲	d 50	FE22	The PID feedback value at the occurrence of a trip is displayed. (Hz/free unit)
Frequency command value (PID-computed)	▲	b 70	FE15	The PID-computed frequency command value at the occurrence of a trip is displayed. (Hz/free unit)
Integral input power	▲	h 85	FE76	The integrated amount of power (kWh) supplied to the inverter is displayed. (0.01=1kWh, 1.00=100kWh)

(Continued overleaf)

(Continued)

Item displayed	Key operated	LED display	Communication No.	Description
Integral output power		H 75	FE77	The integrated amount of power (kWh) supplied from the inverter is displayed. (0.01=1kWh, 1.00=100kWh)
Rated current		R 16.5	FE70	The inverter rated current (A) at the occurrence of a trip is displayed.
Note 7 Past trip 1		OP2 ⇔ 1	FE10	Past trip 1 (displayed alternately)
Note 7 Past trip 2		OH ⇔ 2	FE11	Past trip 2 (displayed alternately)
Note 7 Past trip 3		OP3 ⇔ 3	FE12	Past trip 3 (displayed alternately)
Note 7 Past trip 4		n Err ⇔ 4	FE13	Past trip 4 (displayed alternately)
Note 8 Parts replacement alarm information		n . . . .	FE79	The ON/OFF status of each of the cooling fan, circuit board capacitor, main circuit capacitor of parts replacement alarm or cumulative operation time are displayed in bits.  ON: 1 OFF: 0   Cumulative operation time      Cooling fan Control circuit board capacitor Main circuit capacitor
Note 9 Cumulative operation time		t 0 . 0	FE14	The cumulative operation time is displayed. (0.01=1 hour, 1.00=100 hours)
Default display mode		OP2		The cause of the trip is displayed.

Note 1: Items displayed can be changed by pressing or key in the each monitor mode.

Note 2: You can switch between % and A (ampere)/V (volt), using the parameter  $F 7 0 1$  (current/voltage unit selection).

Note 3: The input (DC) voltage displayed is  $1. \sqrt{2}$  times as large as the rectified d.c. input voltage.

Note 4: The number of bars displayed varies depending on the setting of  $F 1 0 9$  (analog input/logic input function selection). The bar representing VIA or VIB is displayed only when the logic input function is assigned to the VIA or VIB terminal, respectively.

If  $F 1 0 9 = 0$ : Neither the bar representing VIA nor the bar representing VIB is displayed.

If  $F 1 0 9 = 1$  or  $2$ : The bar representing VIA is not displayed.

The bar representing VIB is displayed.

If  $F 1 0 9 = 3$  or  $4$ : Both the bar representing VIA and VIB are displayed.

Note 5: The number of bars displayed varies depending on the setting of  $F 6 6 9$  (logic output/pulse train output selection). The bar representing the OUT-NO terminal is displayed only when logic output function is assigned to it.

If  $F 6 6 9 = 0$ : The bar representing OUT-NO is displayed.

If  $F 6 6 9 = 1$ : The bar representing OUT-NO is not displayed.

- Note 6: The integrated amounts of input and output power will be reset to zero, if you press and hold down the **(ENT)** key for 3 seconds or more when power is off or when the input terminal function CKWH (input terminal function: 51) is turned on or displayed.
- Note 7: Past trip records are displayed in the following sequence: 1 (latest trip record)  $\leftrightarrow$  2  $\leftrightarrow$  3  $\leftrightarrow$  4 (oldest trip record). If no trip occurred in the past, the message "n E r r" will be displayed. Details on past trip record 1, 2, 3 or 4 can be displayed by pressing the **(ENT)** key when past trip 1, 2, 3 or 4 is displayed. For more information, see 8.1.2.
- Note 8: Parts replacement alarm is displayed based on the value calculated from the annual average ambient temperature, the ON time of the inverter, the operating time of the motor and the output current (load factor) specified using F E 3 4. Use this alarm as a guide only, since it is based on a rough estimation.
- Note 9: The cumulative operation time increments only when the machine is in operation.
- Note 10: At the occurrence of a trip, maximum values are not always recorded and displayed for reasons of detecting time.
- Note 11: If there is no trip record, n E r r is displayed.
- ☆ Of the items displayed on the monitor, the reference values of items expressed in percent are listed below.
- Load current: The current monitored is displayed. The reference value (100% value) is the rated output current indicated on the nameplate. That is, it corresponds to the rated current at the time when the PWM carrier frequency (F 3 0 0) is 4kHz or less. The unit can be switched to A (amperes).
  - Input voltage: The voltage displayed is the voltage determined by converting the voltage measured in the DC section into an AC voltage. The reference value (100% value) is 200 volts for 240V models, 400 volts for 500V models or 575 volts for 600V models. The unit can be switched to V (volts).
  - Torque: The torque generated by the drive motor is displayed. The reference value (100% value) is the rated torque of the motor.
  - Torque current: The current required to generate torque is calculated from the load current by vector operations. The value thus calculated is displayed. The reference value (100% value) is the value at the time when the load current is 100%.
  - Load factor of inverter: Depending on the PWM carrier frequency (F 3 0 0) setting and so on, the actual rated current may become smaller than the rated output current indicated on the nameplate. With the actual rated current at that time (after a reduction) as 100%, the proportion of the load current to the rated current is indicated in percent. The load factor is also used to calculate the conditions for overload trip (0 L I).
  - PBR cumulative load factor: The load factor of the braking resistor that may come up to the level at which an overload trip (0 L r) occurs is indicated in percent. An overload trip occurs when it reaches 100%.

## 9. Measures to satisfy the standards

### 9.1 How to cope with the CE directive

In Europe, the EMC directive and the low-voltage directive, which took effect in 1996 and 1997, respectively, make it obligatory to put the CE mark on every applicable product to prove that it complies with the directives. Inverters do not work alone but are designed to be installed in a control panel and always used in combination with other machines or systems which control them, so they themselves are not considered to be subject to the EMC directive. However, the CE mark must be put on all inverters because they are subject to the low-voltage directive.

The CE mark must be put on all machines and systems with built-in inverters because such machines and systems are subject to the above directives. It is the responsibility of the manufacturers of such final products to put the CE mark on each one. If they are "final" products, they might also be subject to machine-related directives.

It is the responsibility of the manufacturers of such final products to put the CE mark on each one. In order to make machines and systems with built-in inverters compliant with the EMC directive and the low-voltage directive, this section explains how to install inverters and what measures should be taken to satisfy the EMC directive.

We have tested representative models with them installed as described later in this manual to check for conformity with the EMC directive. However, we cannot check all inverters for conformity because whether or not they conform to the EMC direction depends on how they are installed and connected. In other words, the application of the EMC directive varies depending on the composition of the control panel with a built-in inverter(s), the relationship with other built-in electrical components, the wiring condition, the layout condition, and so on. Therefore, please verify yourself whether your machine or system conforms to the EMC directive.

#### 9.1.1 About the EMC directive

Inverters themselves are not subject to approval for CE marking.

The CE mark must be put on every final product that includes an inverter(s) and a motor(s). The VF-S11 series of inverters complies with the EMC directive if an EMI filter recommended by Toshiba is connected to it and wiring is carried out correctly.

■ EMC directive 89/336/EEC

The EMC standards are broadly divided into two categories; immunity- and emission-related standards, each of which is further categorized according to the operating environment of each individual machine. Since inverters are intended for use with industrial systems under industrial environments, they fall within the EMC categories listed in Table 1 below. The tests required for machines and systems as final products are almost the same as those required for inverters.

Table 1 EMC standards

Category	Subcategory	Product standards	Test standard and level
Emission	Radiation noise	IEC 61800-3	EN55011 Class A Group 1
	Transmission noise		EN55011 Class A Group 1
Immunity	Static discharge		IEC61000-4-2
	Radioactive radio-frequency magnetic contactor field		IEC61000-4-3
	First transient burst		IEC61000-4-4
	Lightning surge		IEC61000-4-5
	Radio-frequency induction/transmission interference		IEC61000-4-6
	Voltage dip/interruption of power		IEC61000-4-11

Emission standards other than the above are applied to inverters when used in a commercial environment but not an industrial environment.

Category	Subcategory	Product standards	Test standard and level
Emission	Radiation noise	IEC 61800-3	EN55011 Class B Group 1
	Transmission noise		EN55011 Class B Group 1

## 9.1.2 Measures to satisfy the EMC directive

This subsection explains what measures must be taken to satisfy the EMC directive.

- (1) Insert a recommended EMI filter (Table 2) on the input side of the inverter to reduce and transmission noise and radiation noise from input cables.

In the combinations listed in Table 2, Inverters are tested in these combination to see if they comply with transmission noise standards. For inverters used in Japan, it is recommended to use the NF series of noise filters.

Table 2 lists noise filters recommended for the inverters.

Table 2 Combinations of inverter and EMI filter

Three-phase 240V class

Inverter	Combination of inverter and filter	
	Transmission noise EN55011 Class A Group 1 Applicable filters (Length of motor connecting cable: Max. 5 m)	Transmission noise EN55011 Class B Group 1 Applicable filters (Length of motor connecting cable: Max. 1 m)
VFS11-2002PM		EMFS11-2007AZ
VFS11-2004PM		EMFS11-2007AZ
VFS11-2005PM		EMFS11-2007AZ
VFS11-2007PM		EMFS11-2007AZ
VFS11-2015PM		EMFS11-4015BZ
VFS11-2022PM		EMFS11-4015BZ
VFS11-2037PM		EMFS11-4025CZ
VFS11-2055PM		EMFS11-4047DZ
VFS11-2075PM		EMFS11-4047DZ
VFS11-2110PM		EMFS11-2083EZ
VFS11-2150PM		EMFS11-2083EZ

## Three-phase 500V class

Combination of inverter and filter			
Inverter	Transmission noise EN55011 Class A Group 1 Applicable filters (Length of motor connecting cable: Max. 5 m)	Transmission noise EN55011 Class B Group 1 Applicable filters (Length of motor connecting cable: Max. 20 m)	Transmission noise EN55011 Class A Group 1 Applicable filters (Length of motor connecting cable: Max. 50 m)
VFS11-4004PL	With a built-in filter		EMFS11-4015BZ
VFS11-4007PL	With a built-in filter		EMFS11-4015BZ
VFS11-4015PL	With a built-in filter		EMFS11-4015BZ
VFS11-4022PL	With a built-in filter		EMFS11-4025CZ
VFS11-4037PL	With a built-in filter		EMFS11-4025CZ
VFS11-4055PL	With a built-in filter		EMFS11-4047DZ
VFS11-4075PL	With a built-in filter		EMFS11-4047DZ
VFS11-4110PL	With a built-in filter		EMFS11-4049EZ
VFS11-4150PL	With a built-in filter		EMFS11-4049EZ

## Single-phase 240V class

Combination of inverter and filter			
Inverter	Transmission noise EN55011 Class A Group 1 Applicable filters (Length of motor connecting cable: Max. 5 m)	Transmission noise EN55011 Class B Group 1 Applicable filters (Length of motor connecting cable: Max. 20 m)	Transmission noise EN55011 Class A Group 1 Applicable filters (Length of motor connecting cable: Max. 50 m)
VFS11S-2002PL	With a built-in filter		EMFS11S-2009AZ
VFS11S-2004PL	With a built-in filter		EMFS11S-2009AZ
VFS11S-2007PL	With a built-in filter		EMFS11S-2009AZ
VFS11S-2015PL	With a built-in filter		EMFS11S-2016BZ
VFS11S-2022PL	With a built-in filter		EMFS11S-2022CZ

Note : For 600V models compliant with EU standards, contact your nearest Toshiba inverter distributor.

- (2) Use shielded power cables, such as inverter output cables, and shielded control cables. Route the cables and wires so as to minimize their lengths. Keep a distance between the power cable and the control cable and between the input and output wires of the power cable. Do not route them in parallel or bind them together, instead cross at right angle.
- (3) Install the inverter and the filter on the same metal plate. It is more effective in limiting the radiation noise to install the inverter in a sealed steel cabinet. Using wires as thick and short as possible, earth the metal plate and the control panel securely with a distance kept between the earth cable and the power cable.
- (4) Route the EMI filter input and output wires apart from each other.
- (5) To suppress radiation noise from cables, ground all shielded cables through a noise cut plate. It is effective to earth shielded cables in the vicinity of the inverter, cabinet and filter (within a radius of 10cm from each of them). Inserting a ferrite core in a shielded cable is even more effective in limiting the radiation noise.
- (6) To further limit the radiation noise, insert a zero-phase reactor in the inverter output line and insert ferrite cores in the earth cables of the metal plate and cabinet.

[Example of wiring]

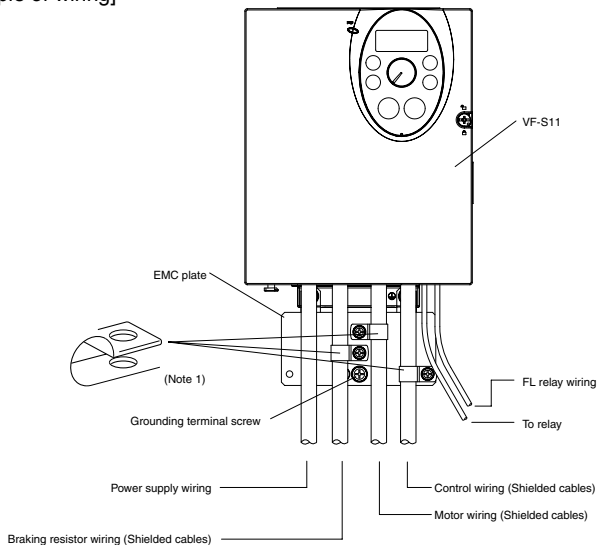

Note 1: Strip and earth the shielded cable, following the example shown in Fig.

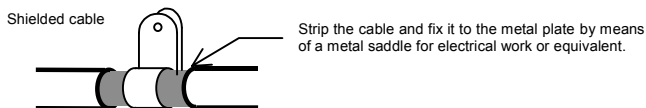

## 9.1.3 About the low-voltage directive

The low-voltage directive provides for the safety of machines and systems. All Toshiba inverters are CE-marked in accordance with the standard EN 50178 specified by the low-voltage directive, and can therefore be installed in machines or systems and imported without problem to European countries.

Applicable standard: EN50178

Electronic equipment for use in power installations

Electronic equipment for use in power installations

Pollution level: 2 (5.2.15.2)

Overvoltage category: 3

240V class - 3.0mm (5.2.16.1)

500V class - 5.5mm (5.2.16.1)

EN 50178 applies to electrical equipment intended specially for use in power installations, and sets out the conditions to be observed for electric shock prevention when designing, testing, manufacturing and installing electronic equipment for use in power installations.

## 9.1.4 Measures to satisfy the low-voltage directive

When incorporating the inverter into a machine or system, it is necessary to take the following measures so that the inverter satisfies the low-voltage directive.

- (1) Install the inverter in a cabinet and ground the inverter enclosure. When doing maintenance, be extremely careful not to put your fingers into the inverter through a wiring hole and touch a charged part, which may occur depending on the model and capacity of the inverter used.
- (2) Do not connect two or more wires to the main circuit earth terminal of the inverter. If necessary, install an additional earth terminal on the metal plate on which the inverter is installed and connect another cable to it. Or install the EMC plate (attached as standard) and another cable connect to earth terminal on the EMC plate. Refer to the table 10.1 for earth cable sizes.
- (3) Install a non-fuse circuit breaker or a fuse on the input side of the inverter.

## 9.2 Compliance with UL Standard and CSA Standard

The VF-S11 models, that conform to the UL Standard and CSA Standard have the UL/CSA mark on the nameplate.

### 9.2.1 Compliance with Installation

The VF-S11 inverter must be installed in a panel, and used within the ambient temperature specification. (See section 1.4.4)

### 9.2.2 Compliance with Connection

Use the UL conformed cables (Rating 75 °C or more) to the main circuit terminals (R/L1, S/L2, T/L3, U/T1, V/T2, W/T3, PA+, PB, PC-, PO).

Refer to the table of next page about wire sizes.

### 9.2.3 Compliance with Peripheral devices

Use the UL listed fuses at connecting to power supply.

Short circuit test is performed under the condition of the power supply short-circuit currents in below.

These interrupting capacities and fuse rating currents depend on the applicable motor capacities.

## ■ AIC, Fuse and Wire sizes

Voltage class	Capacity of applicable motor (kW)	Inverter model	AIC (A) (Interrupting capacity)	Fuse class and current (A)	Wire sizes of power circuit
Single-phase 240V class	0.2	VFS11S-2002PL	AIC 1000A	CC/J 6A max.	AWG14
	0.4	VFS11S-2004PL	AIC 1000A	CC/J 10A max.	AWG14
	0.75	VFS11S-2007PL	AIC 1000A	CC/J 15A max.	AWG14
	1.5	VFS11S-2015PL	AIC 1000A	CC/J 20A max.	AWG12
	2.2	VFS11S-2022PL	AIC 1000A	CC/J 30A max.	AWG10
Three-phase 240V class	0.4	VFS11-2004PM	AIC 5000A	CC/J 6A max.	AWG14
	0.55	VFS11-2005PM	AIC 5000A	CC/J 10A max.	AWG14
	0.75	VFS11-2007PM	AIC 5000A	CC/J 10A max.	AWG14
	1.5	VFS11-2015PM	AIC 5000A	CC/J 15A max.	AWG14
	2.2	VFS11-2022PM	AIC 5000A	CC/J 20A max.	AWG12
	4.0	VFS11-2037PM	AIC 5000A	J 35A max.	AWG10
	5.5	VFS11-2055PM	AIC 22000A	J 50A max.	AWG8
	7.5	VFS11-2075PM	AIC 22000A	J 60A max.	AWG6
	11	VFS11-2110PM	AIC 22000A	J 80A max.	AWG4
15	VFS11-2150PM	AIC 22000A	J 110A max.	AWG6 x 2	
Three-phase 500V class	0.4	VFS11-4004PL	AIC 5000A	CC/J 3A max.	AWG14
	0.75	VFS11-4007PL	AIC 5000A	CC/J 6A max.	AWG14
	1.5	VFS11-4015PL	AIC 5000A	CC/J 10A max.	AWG14
	2.2	VFS11-4022PL	AIC 5000A	CC/J 15A max.	AWG14
	4.0	VFS11-4037PL	AIC 5000A	CC/J 20A max.	AWG12
	5.5	VFS11-4055PL	AIC 22000A	CC/J 30A max.	AWG10
	7.5	VFS11-4075PL	AIC 22000A	J 35A max.	AWG8
	11	VFS11-4110PL	AIC 22000A	J 50A max.	AWG8
15	VFS11-4150PL	AIC 22000A	J 70A max.	AWG6	
Three-phase 600V class	0.75	VFS11-6007P	AIC 5000A	CC/J 6A max.	AWG14
	1.5	VFS11-6015P	AIC 5000A	CC/J 6A max.	AWG14
	2.2	VFS11-6022P	AIC 5000A	CC/J 10A max.	AWG14
	4.0	VFS11-6037P	AIC 5000A	CC/J 15A max.	AWG14
	5.5	VFS11-6055P	AIC 22000A	CC/J 20A max.	AWG10
	7.5	VFS11-6075P	AIC 22000A	CC/J 25A max.	AWG10
	11	VFS11-6110P	AIC 22000A	J 30A max.	AWG8
	15	VFS11-6150P	AIC 22000A	J 45A max.	AWG8

### 9.2.4 Motor thermal protection

Selects the electronic thermal protection characteristics that fit with the ratings and characteristics of the motor. In case of multi motor operation with one inverter, thermal relay should be connected to each motor.

# 10. Peripheral devices



Danger

 Mandatory	<ul style="list-style-type: none"> <li>When using switchgear for the inverter, it must be installed in a cabinet. Failure to do so can lead to risk of electric shock and can result in death or serious injury.</li> </ul>
 Prohibited	<ul style="list-style-type: none"> <li>Connect earth cables securely. Failure to do so can lead to risk of electric shock or fire in case of a failure or short-circuit or electric leak.</li> </ul>

## 10.1 Selection of wiring materials and devices

Voltage class	Capacity of applicable motor (kW)	Inverter model	Wire size (See Note 4)			
			Power circuit (mm <sup>2</sup> ) (Note 1.)	DC reactor (optional) (mm <sup>2</sup> )	Braking resistor/ Braking unit (optional) (mm <sup>2</sup> )	Earth cable (mm <sup>2</sup> )
Single-phase 240V class	0.2	VFS11S-2002PL	2.0 (2.0)	2.0	2.0	3.5
	0.4	VFS11S-2004PL	2.0 (2.0)	2.0	2.0	3.5
	0.75	VFS11S-2007PL	2.0 (2.0)	2.0	2.0	3.5
	1.5	VFS11S-2015PL	2.0 (2.0)	2.0	2.0	3.5
	2.2	VFS11S-2022PL	2.0 (2.0)	3.5	2.0	3.5
Three-phase 240V class	0.4	VFS11-2004PM	2.0 (2.0)	1.25	2.0	3.5
	0.55	VFS11-2005PM	2.0 (2.0)	2.0	2.0	3.5
	0.75	VFS11-2007PM	2.0 (2.0)	2.0	2.0	3.5
	1.5	VFS11-2015PM	2.0 (2.0)	2.0	2.0	3.5
	2.2	VFS11-2022PM	2.0 (2.0)	2.0	2.0	3.5
	4.0	VFS11-2037PM	2.0 (2.0)	3.5	2.0	3.5
	5.5	VFS11-2055PM	5.5 (2.0)	8.0	2.0	5.5
	7.5	VFS11-2075PM	8.0 (5.5)	14	3.5	5.5
	11	VFS11-2110PM	14 (8.0)	14	5.5	8.0
	15	VFS11-2150PM	22 (14)	22	14	8.0
Three-phase 500V class	0.4	VFS11-4004PL	2.0 (2.0)	2.0	2.0	3.5
	0.75	VFS11-4007PL	2.0 (2.0)	2.0	2.0	3.5
	1.5	VFS11-4015PL	2.0 (2.0)	2.0	2.0	3.5
	2.2	VFS11-4022PL	2.0 (2.0)	2.0	2.0	3.5
	4.0	VFS11-4037PL	2.0 (2.0)	2.0	2.0	3.5
	5.5	VFS11-4055PL	2.0 (2.0)	3.5	2.0	3.5
	7.5	VFS11-4075PL	3.5 (2.0)	5.5	2.0	3.5
	11	VFS11-4110PL	5.5 (2.0)	8.0	2.0	5.5
	15	VFS11-4150PL	8.0 (5.5)	14	3.5	5.5
Three-phase 600V class	0.75	VFS11-6007P	2.0	2.0	2.0	3.5
	1.5	VFS11-6015P	2.0	2.0	2.0	3.5
	2.2	VFS11-6022P	2.0	2.0	2.0	3.5
	4.0	VFS11-6037P	2.0	2.0	2.0	3.5
	5.5	VFS11-6055P	2.0	2.0	2.0	3.5
	7.5	VFS11-6075P	2.0	2.0	2.0	3.5
	11	VFS11-6110P	3.5	3.5	2.0	3.5
	15	VFS11-6150P	5.5	5.5	2.0	5.5

Note 1: Sizes of the wires connected to the input terminals R/L1, S/L2 and T/L3 and the output terminals U/T1, V/T2 and W/T3 when the length of each wire does not exceed 30m.

The numeric values in parentheses refer to the sizes of wires to be used when a DC reactor is connected.

10

Note 2: For the control circuit, use shielded wires 0.75 mm<sup>2</sup> or more in diameter.

Note 3: For grounding, use a cable with a size equal to or larger than the above.

Note 4: The wire sizes specified in the above table apply to HIV wires (copper wires shielded with an insulator with a maximum allowable temperature of 75°C) used at an ambient temperature of 50°C or less.

Note 5: If there is a need to bring the inverter into UL compliance, use wires specified in Chapter 9.

## ■ Selection of wiring devices

Voltage class	Capacity of applicable motor (kW)	Inverter model	Molded case circuit breaker (MCCB) Earth leakage circuit breaker (ELCB) Note 3)		Magnetic contactor (MC)		Overload relay (THR)
			Rated current (A)		Rated current (A)		Adjusted current (A) (For reference)
			Without reactor	With DC reactor	Without reactor	With DC reactor	
Single-phase 240V class	0.2	VFS11S-2002PL	5	5	9	9	1.3
	0.4	VFS11S-2004PL	10	5	9	9	2.3
	0.75	VFS11S-2007PL	15	10	9	9	3.6
	1.5	VFS11S-2015PL	20	15	18	12	6.8
	2.2	VFS11S-2022PL	30	30	25	18	9.3
Three-phase 240V class	0.4	VFS11-2004PM	5	5	9	9	2.3
	0.55	VFS11-2005PM	10	5	9	9	2.7
	0.75	VFS11-2007PM	10	5	9	9	3.6
	1.5	VFS11-2015PM	15	10	9	9	6.8
	2.2	VFS11-2022PM	20	15	12	12	9.3
	4.0	VFS11-2037PM	30	30	25	18	15
	5.5	VFS11-2055PM	50	40	32	25	22
	7.5	VFS11-2075PM	60	50	38	38	28
	11	VFS11-2110PM	100	75	65	50	44
15	VFS11-2150PM	125	100	80	65	57	
Three-phase 500V class (Note 4)	0.4	VFS11-4004PL	5	5	9	9	1.0
	0.75	VFS11-4007PL	5	5	9	9	1.6
	1.5	VFS11-4015PL	10	10	9	9	3.6
	2.2	VFS11-4022PL	15	10	9	9	5.0
	4.0	VFS11-4037PL	20	15	12	9	6.8
	5.5	VFS11-4055PL	30	20	18	18	11
	7.5	VFS11-4075PL	30	30	25	18	15
Three-phase 600V class (Note 4)	11	VFS11-4110PL	50	40	32	25	22
	15	VFS11-4150PL	60	50	38	38	28
	0.75	VFS11-6007P	5	5	9	9	1.0
	1.5	VFS11-6015P	10	10	9	9	1.6
	2.2	VFS11-6022P	10	10	9	9	3.6
	4.0	VFS11-6037P	15	15	12	12	5.0
	5.5	VFS11-6055P	20	20	18	18	6.8
7.5	VFS11-6075P	30	30	25	25	11	
11	VFS11-6110P	30	30	25	25	15	
15	VFS11-6150P	40	40	33	33	22	

Note 1: Be sure to attach a surge killer to the exciting coil of the relay and the magnetic contactor.

Note 2: When using the auxiliary contacts 2a of the magnetic contactor MC for the control circuit, connect the contacts 2a in parallel to increase reliability.

Note 3: Select an MCCB with a current breaking rating appropriate to the capacity of the power supply, because short-circuit currents vary greatly depending on the capacity of the power supply and the condition of the wiring system. The MCCB, MC, THR and ELCB in this table were selected, on the assumption that a power supply with a normal capacity would be used.

Note 4: 500 / 600V class: For the operation and control circuits, regulate the voltage at 240V or less with a step-down transformer.

## 10.2 Installation of a magnetic contactor

If using the inverter without installing a magnetic contactor (MC) in the primary circuit, use an MCCB (with a power cutoff device) to open the primary circuit when the inverter protective circuit is activated.

If using a braking resistor or braking resistor unit, install a magnetic contactor (MC) or non-fuse circuit breaker with a power cutoff device to the power supply of the inverter, so that the power circuit opens when the failure detection relay (FL) in the inverter or the external overload relay is activated.

### ■ Magnetic contactor in the primary circuit

To detach the inverter from the power supply in any of the following cases, insert a magnetic contactor (primary-side magnetic contactor) between the inverter and the power supply.

- (1) If the motor overload relay is tripped
- (2) If the protective detector (FL) built into the inverter is activated
- (3) In the event of a power failure (for prevention of auto-restart)
- (4) If the resistor protective relay is tripped when a braking resistor or braking resistor unit is used

When using the inverter with no magnetic contactor (MC) on the primary side, install a non-fuse circuit breaker with a voltage tripping coil instead of an MC and adjust the circuit breaker so that it will be tripped if the protective relay referred to above is activated. To detect a power failure, use an undervoltage relay or the like.

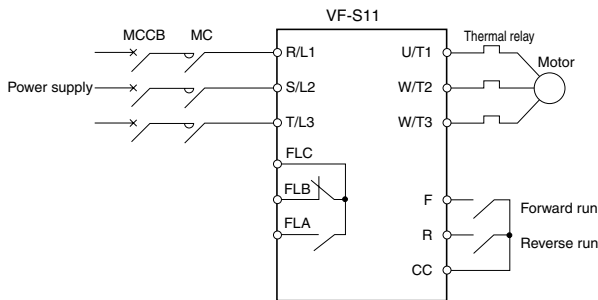

Example of connection of a magnetic contactor in the primary circuit

### Notes on wiring

- When frequently switching between start and stop, do not use the magnetic contactor on the primary side as an on-off switch for the inverter.  
Instead, stop and start the inverter by using terminals F and CC (forward run) or R and CC (reverse run).
- Be sure to attach a surge killer to the exciting coil of the magnetic contactor (MC).

## ■ Magnetic contactor in the secondary circuit

A magnetic contactor may be installed on the secondary side to switch controlled motors or supply commercial power to the load when the inverter is out of operation.

### Notes on wiring

- Be sure to interlock the magnetic contactor on the secondary side with the power supply to prevent commercial power from being applied to the inverter output terminals.
- When installing a magnetic contactor (MC) between the inverter and the motor, avoid turning the magnetic contactor on or off during operation. Turning the magnetic contactor on or off during operation causes a current to rush into the inverter which could lead to malfunction.

## 10.3 Installation of an overload relay

---

---

- 1) The VF-S11 inverter has an electronic-thermal overload protective function. In the following cases, however, an overload relay suitable for the adjustment of the motor electronic thermal protection level ( $I_{tr}$ ) and appropriate to the motor used should be installed between the inverter and the motor.
  - When using a motor with a current rating different to that of the corresponding Toshiba general-purpose motor
  - When operating a single motor with an output smaller than that of the applicable standard motor or more than one motor simultaneously.
- 2) When using the VF-S11 inverter to operate a constant-torque motor, such as the Toshiba VF motor, adjust the protection characteristic of the electronic thermal protection unit ( $I_{tr}$ ) to the VF motor use.
- 3) It is recommended to use a motor with a thermal relay embedded in the motor coil to give sufficient protection to the motor, especially when it runs in a low-speed range.

## 10.4 Optional external devices

The following external devices are optionally available for the VF-S11 series of inverters.

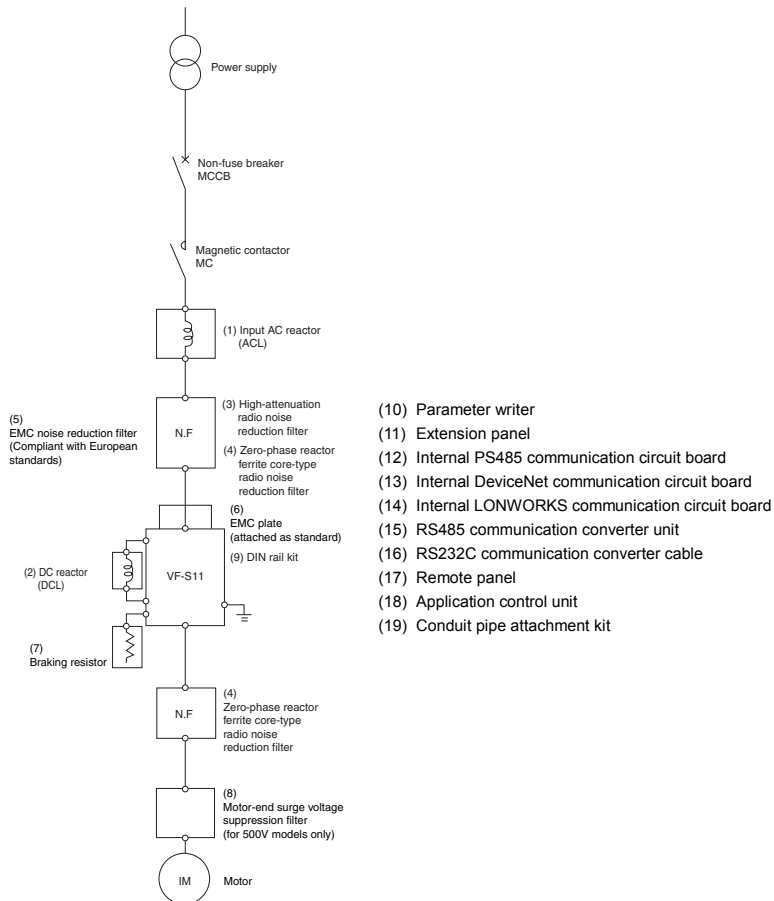

## Optional external devices

No.	Device	Function and purpose																	
(1)	Input AC reactor	Used to improve the input power factor, reduce the harmonics, and suppress external surge on the inverter power source side. Install when the power capacity is 200 kVA or more and 10 times or more than the inverter capacity or when a distorted wave generation source such as a thyristor unit or a large-capacity inverter is connected in the same distribution system. <table border="1" data-bbox="347 245 952 362"> <thead> <tr> <th rowspan="2">Reactor type</th> <th rowspan="2">Improvement of power factor</th> <th colspan="2">Effect</th> <th rowspan="2">Suppression of external surge</th> </tr> <tr> <th>240V-4.0kW or less</th> <th>Other model</th> </tr> </thead> <tbody> <tr> <td>Input AC reactor</td> <td>○</td> <td>○</td> <td>○</td> <td>○</td> </tr> <tr> <td>DC reactor</td> <td>○ Large</td> <td>○</td> <td>○ Large</td> <td>×</td> </tr> </tbody> </table> <p>○ Large : Large effective. ○ : effective. × : ineffective</p>	Reactor type	Improvement of power factor	Effect		Suppression of external surge	240V-4.0kW or less	Other model	Input AC reactor	○	○	○	○	DC reactor	○ Large	○	○ Large	×
Reactor type	Improvement of power factor	Effect			Suppression of external surge														
		240V-4.0kW or less	Other model																
Input AC reactor	○	○	○	○															
DC reactor	○ Large	○	○ Large	×															
(2)	DC reactor	Improves the power factor more than the input reactor. When the facility applying the inverter requires high reliability, it is recommended to use the DC reactor with an input reactor effective for external surge suppression.																	
(3)	Radio noise reduction filter	High-attenuation (NF type) These types of filters are not necessary because all single-phase 200V or 3-phase 400V models have a built-in EMI noise filter, conforming to Class A, as standard. But install these filters if necessarily of noise reduction move and more. <ul style="list-style-type: none"> <li>Effective to prevent interference in audio equipment used near the inverter.</li> <li>Install on the input side of the inverter.</li> <li>Provided with wide-range attenuation characteristics from AM radio bands to near 10MHz.</li> <li>Use when equipment readily affected by noise is installed in the peripheral area.</li> </ul>																	
(4)		Zero-phase reactor ferrite core-type <ul style="list-style-type: none"> <li>Effective to prevent interference in audio equipment used near the inverter.</li> <li>Effective in noise reduction on both input and output sides of the inverter.</li> <li>Provided with attenuation characteristics of several dB in frequencies from AM radio bands to 10MHz.</li> <li>For noise countermeasures, insert on the secondary side of the inverter.</li> </ul>																	
(5)	EMC Noise reduction filter (Compliant with European standards)	A high-attenuation compact EMI noise filter that can be Foot-mounted and Side-mounted. With this filter on, the inverter complies with the following standards.  Three-phase 240V model: EN55011: Class A, Group 1 (Motor connecting cable length: 5 m or less) And EN55011: Class B, Group 1 (Motor connecting cable length: 1 m or less)  Single-phase 240V, three-phase 500V models: And EN55011: Class A, Group 1 (Motor connecting cable length: 50 m or less) EN55011: Class B, Group 1 (Motor connecting cable length: 20 m or less)																	
(6)	EMC plate (attached as standard)	A steel plate used to connect shielded earth wires from inverter's power cables or to connect earth wires from external devices.																	
(7)	Braking resistor	Use when rapid deceleration or stop is frequently required or when it is desired to reduce the deceleration time with large load. This resistor consumes regenerative energy during power generation braking. <ul style="list-style-type: none"> <li>Braking resistor - With (resistor + protective thermal relay) built in.</li> </ul>																	
(8)	Motor - end surge voltage suppression filter (500V class only)	Use an insulation-reinforced motor or install the surge voltage restraint filter to prevent degrading motor insulation caused by surge voltage generation depending on cable length and wiring method, or use of a 500V class motor driven with an inverter.																	

No.	Device	Function and purpose
(9)	DIN rail kit	Available for 2.2kW or 1.5kW models and lower. (Model: DIN003Z, DIN005Z)
(10)	Parameter writer Note 1)	Use this unit for batch read, batch copy, and batch writing of setting parameters. (Model: PWU001Z)
(11)	Extension panel Note 1)	Extended operation panel kit provided with LED indication section, RUN/STOP key, UP/DOWN key, Monitor key, and Enter key. (Model: RKP001Z)
(12)	Internal RS485 communication circuit board	This unit allows you to connect a upper controller to multiple inverters for data transfer. (Model: RS4003Z)
(13)	Internal DeviceNet communication circuit board	This unit allows you to connect a upper controller to multiple inverters for data transfer. (Model : DEV001Z)
(14)	Internal LONWORKS communication circuit board	This unit allows you to connect a upper controller to multiple inverters for data transfer. (Model : LIU005Z)
(15)	RS485 communication converter unit Note 1)	This unit allows you to connect a upper controller to multiple inverters for data transfer. (Models: RS4001Z, RS4002Z)
(16)	RS232C communication converter cable	This unit allows you to connect a personal computer to inverters for data communications. (Model: RS20035)
(17)	Remote panel	This panel includes a frequency meter, a frequency regulator and RUN/STOP (forward/reverse run) switches. (Model: CBVR-7B1)
(18)	Application control unit	The AP series of control units is available for the inverter to allow it to perform various kinds of applied control. Contact your Toshiba representative for further information.
(19)	Conduit pipe attachment kit	Attachment kit used for conformance to NEMA TYPE1.

Note 1: Dedicated cables are needed to connect inverters to a personal computer.

Cable models: CAB0011 (1m)

CAB0013 (3m)

CAB0015 (5m)

Table for selection of optional external devices

Voltage class	Capacity of applicable motor (kW)	Inverter model	Input AC reactor	DC reactor	Radio noise reduction filter		Braking resistor	Motor-end surge voltage suppression filter	EMC plate (Note 2)	EMC noise filter (Compliant with European standards)	DIN rail kit
					High attenuation type	Core type (Note 1.)					
Single-phase 240V class	0.2	VFS11S-2002PL	PFL-2002S	DCLS-2002	-	RC5078	PBR-2007	-	EMP003Z	EMFS11S-2009AZ	DIN003Z
	0.4	VFS11S-2004PL	PFL-2005S	DCL-2007	-	RC5078	PBR-2007	-	EMP003Z	EMFS11S-2009AZ	DIN003Z
	0.75	VFS11S-2007PL	PFL-2011S	DCL-2022	-	RC5078	PBR-2007	-	EMP003Z	EMFS11S-2009AZ	DIN003Z
	1.5	VFS11S-2015PL	PFL-2018S	DCL-2037	-	RC5078	PBR-2022	-	EMP004Z	EMFS11S-2018BZ	DIN005Z
	2.2	VFS11S-2022PL	PFL-2018S	DCL-2037	-	RC5078	PBR-2022	-	EMP004Z	EMFS11S-2022CZ	-
Three-Phase 240V class	0.2	VFS11-2002PM	PFL-2001S	DCL-2002	NF3005A-MJ	RC5078	PBR-2007	-	EMP003Z	EMFS11-2007AZ	DIN003Z
	0.4	VFS11-2004PM	PFL-2005S	DCL-2007	NF3005A-MJ	RC5078	PBR-2007	-	EMP003Z	EMFS11-2007AZ	DIN003Z
	0.55	VFS11-2005PM	PFL-2005S	DCL-2007	NF3005A-MJ	RC5078	PBR-2007	-	EMP003Z	EMFS11-2007AZ	DIN003Z
	0.75	VFS11-2007PM	PFL-2005S	DCL-2007	NF3005A-MJ	RC5078	PBR-2007	-	EMP003Z	EMFS11-2007AZ	DIN003Z
	1.5	VFS11-2015PM	PFL-2011S	DCL-2022	NF3015A-MJ	RC5078	PBR-2022	-	EMP004Z	EMFS11-4015BZ	DIN005Z
	2.2	VFS11-2022PM	PFL-2011S	DCL-2022	NF3015A-MJ	RC5078	PBR-2022	-	EMP004Z	EMFS11-4015BZ	DIN005Z
	3.7	VFS11-2037PM	PFL-2018S	DCL-2037	NF3020A-MJ	RC5078	PBR-2037	-	EMP004Z	EMFS11-4025CZ	-
	5.5	VFS11-2055PM	PFL-2025S	DCL-2055	NF3030A-MJ	RC9129	PBR3-2055	-	EMP005Z	EMFS11-4047DZ	-
	7.5	VFS11-2075PM	PFL-2050S	DCL-2110	NF3040A-MJ	RC9129	PBR3-2075	-	EMP005Z	EMFS11-4047DZ	-
	11	VFS11-2110PM	PFL-2050S	DCL-2110	NF3050A-MJ	RC9129	PBR3-2110	-	EMP006Z	EMFS11-2083EZ	-
Three-Phase 500V class	15	VFS11-2150PM	PFL-2100S	DCL-2220	NF3080A-MJ	RC9129	PBR3-2150	-	EMP006Z	EMFS11-2083EZ	-
	0.4	VFS11-4004PL	PFL-4012S	DCL-2007	NF3010C-MJ	RC5078	PBR-2007	MSF-4015Z	EMP004Z	EMFS11-4015BZ	DIN005Z
	0.75	VFS11-4007PL	PFL-4012S	DCL-2007	NF3010C-MJ	RC5078	PBR-2007	MSF-4015Z	EMP004Z	EMFS11-4015BZ	DIN005Z
	1.5	VFS11-4015PL	PFL-4012S	DCL-2007	NF3010C-MJ	RC5078	PBR-2007	MSF-4015Z	EMP004Z	EMFS11-4015BZ	DIN005Z
	2.2	VFS11-4022PL	PFL-4012S	DCL-2022	NF3010C-MJ	RC5078	PBR-2007	MSF-4037Z	EMP004Z	EMFS11-4025CZ	-
	3.7	VFS11-4037PL	PFL-4012S	DCL-2022	NF3010C-MJ	RC5078	PBR-4037	MSF-4037Z	EMP004Z	EMFS11-4025CZ	-
	5.5	VFS11-4055PL	PFL-4025S	DCL-4110	NF3015C-MJ	RC9129	PBR3-4055	MSF-4075Z	EMP005Z	EMFS11-4047DZ	-
Three-Phase 600V class	7.5	VFS11-4075PL	PFL-4025S	DCL-4110	NF3020C-MJ	RC9129	PBR3-4075	MSF-4075Z	EMP005Z	EMFS11-4047DZ	-
	11	VFS11-4110PL	PFL-4025S	DCL-4110	NF3030C-MJ	RC9129	PBR3-4110	MSF-4150Z	EMP006Z	EMFS11-4049EZ	-
	15	VFS11-4150PL	PFL-4050S	DCL-4220	NF3040C-MJ	RC9129	PBR3-4150	MSF-4150Z	EMP006Z	EMFS11-4049EZ	-
	0.75	VFS11-6007P				RC5078			EMP004Z		DIN005Z
	1.5	VFS11-6015P				RC5078			EMP004Z		DIN005Z
	2.2	VFS11-6022P				RC5078			EMP004Z		-
	4.0	VFS11-6037P	(Note 3)	(Note 3)	FN3359HV-150-28 by Schafener	RC5078	(Note 3)		EMP004Z	(Note 3)	-
	5.5	VFS11-6055P				RC9129			EMP005Z		-
	7.5	VFS11-6075P				RC9129			EMP005Z		-
	11	VFS11-6110P				RC9129			EMP006Z		-
	15	VFS11-6150P				RC9129			EMP006Z		-

Note 1: This filter is used wound around the input-side power line. (Number of turns: 4 or more) This filter can be installed on the output side, as well.

Note 2: EMC plate is attached as standard.

Note 3: For 600V models, contact your nearest Toshiba inverter distributor.

Devices		External dimensions and connections											
Input AC reactor (ACL)													
		Fig. A								Fig. B			
Model	Rating	Inverter type	Dimensions (mm)							Diagram	Terminals	Approx. weight (kg)	
			A	B	C	D	E	F	G				
PFLS2002S	1φ-240V-2.0A-50/60Hz	VFS11S-2002PL	80	55	115	63	45	5	45	A	Harmonica terminal M3.5	0.85	
PFL2001S	3φ-240V-1.7A-50/60Hz	VFS11-2002PM	105	65	115	90	55	5	40		Harmonica terminal M3.5	1.0	
PFL2005S	3φ-240V-5.5A-50/60Hz	VFS11-2004 - 2007PM VFS11S-2004PL	105	65	115	90	55	5	40	A	Harmonica terminal M3.5	1.2	
PFL2011S	3φ-240V-11A-50/60Hz	VFS11-2015, 2022PM VFS11S-2007PL	130	70	140	115	60	5	50		Harmonica terminal M4	2.3	
PFL2018S	3φ-240V-18A-50/60Hz	VFS11-2037PM VFS11S-2015, 2022PL	130	70	140	115	60	5	50	A	Harmonica terminal M4	2.5	
PFL2025S	3φ-240V-25A-50/60Hz	VFS11-2059PM	125	100	130	50	83	7	-		Harmonica terminal M4	2.6	
PFL2050S	3φ-240V-50A-50/60Hz	VFS11-2075, 2110PM	155	115	140	50	95	7	-	B	Harmonica terminal M6	3.4	
PFL2100S	3φ-240V-100A-50/60Hz	VFS11-2150PM	230	150	210	60	90	8	-		Harmonica terminal M6	8.2	
PFL4012S	3φ-500V-12.5A-50/60Hz	VFS11-4004 - 4037PL	125	95	130	50	79	7	-	B	Harmonica terminal M4	2.3	
PFL4025S	3φ-500V-25A-50/60Hz	VFS11-4055 - 4110PL	155	110	155	50	94	7	-		Harmonica terminal M4	4.9	
PFL4050S	3φ-500V-50A-50/60Hz	VFS11-4150PL	155	140	165	50	112	7	-		Harmonica terminal M6	6.6	

\* PFLS2002S has 4 terminals.

Devices  
DC reactor  
(DCL)

## External dimensions and connections

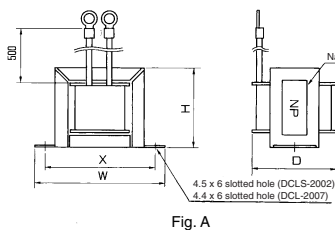

Fig. A

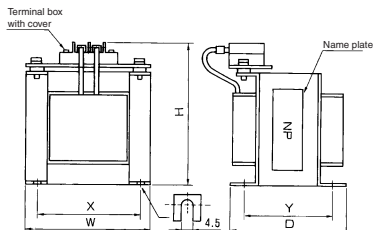

Fig. B

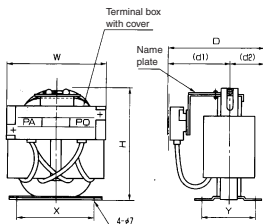
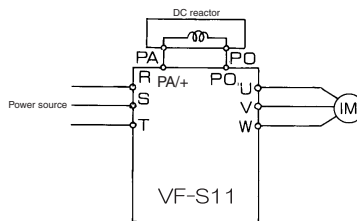

Fig. C



Model	Rated current (A)	Inverter type	Dimensions (mm)								Diagram	Terminals	Approx. weight (kg)
			W	H	D	X	Y	d1	D2				
DCL-2002	2	VFS11-2002PM	59	37	35	51	-	-	-	-	A	V1.2S-3.5	0.2
DCLS-2002	2.5	VFS11-2002PM VFS11S-2002PL	79	50	44	66	-	-	-	-		V1.2S-3.5	0.6
DCL-2007	7	VFS11-2004 - 2007PM VFS11S-2004PL	92	65	70	82	-	-	-	-	B	V2-3.5	1.2
DCL-2022	14	VFS11-2015, 2022PM VFS11S-2007PL	86	110	80	71	64	-	-	-		M4	2.2
DCL-2037	22.5	VFS11-2037PM VFS11S-2015, 2022PL	86	110	85	71	70	-	-	-	C	M4	2.5
DCL-2055	38	VFS11-2055PM	75	130	140	50	85	85	55	-		M5	1.9
DCL-2110	75	VFS11-2075 - 2110PM	100	150	150	65	85	95	55	-	M6	2.4	
DCL-2220	150	VFS11-2150PM	117	170	190	90	130	60	-	-	M8	4.3	
DCL-2007	7	VFS11-4004 - 4015PL (Note)	92	65	70	82	-	-	-	-	A	V2-3.5	1.2
DCL-2022	14	VFS11-4022, 4037PL (Note)	86	110	80	71	64	-	-	-		M4	2.2
DCL-4110	38	VFS11-4055 - 4110PL	95	150	165	70	90	105	60	-	B C	M5	3.0
DCL-4220	75	VFS11-4150PL	105	160	185	80	100	130	85	-		M8	3.7

Note: Use 240V class for VFS11-4004PL-4037PL DC reactor.



Devices  
EMC  
noise filter  
(Compliant  
with  
European  
Standards)

External dimensions and connections

Foot mount installation

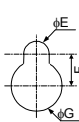
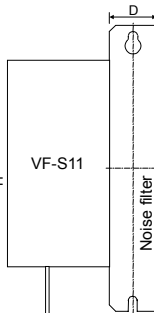
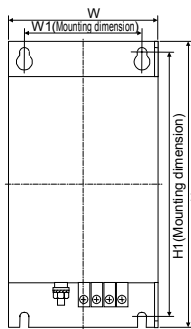

Side mount installation

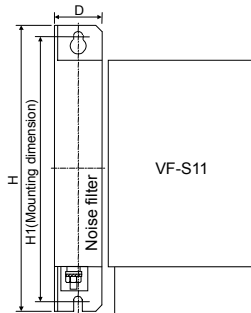

RFI filter type form	Rated current (A)	Inverter type form	Dimensions (mm)							Leakage current (mA) Note 1)		
			W	H	D	W1	H1	E	F	G	Power system A	Power system B
EMFS11S-2009AZ	9	VFS11S-2002-2007PL	72	195	37	52	180	5	8.5	10	3	47
EMFS11-2007AZ	7	VFS11-2002-2007PM	72	195	37	52	180	5	8.5	10	7	45
EMFS11S-2016BZ	16	VFS11S-2015PL	105	195	35	85	180	5	8.5	10	3	47
EMFS11-4015BZ	15	VFS11-2015,2022PM	105	195	42	85	180	5	8.5	10	8	48
EMFS11S-2022CZ	22	VFS11-4034-4015PL	140	235	35	120	215	5	8.5	10	6	96
EMFS11-4025CZ	25	VFS11-2037PM	140	235	50	120	215	5	8.5	10	20	125
EMFS11-4047DZ	47	VFS11-4022,4037PL	180	305	60	140	285	5.5	9.5	11	40	103
EMFS11-2063EZ	83	VFS11-4055,4075PL	245	395	80	205	375	5.5	9.5	11	23	147
EMFS11-4049EZ	49	VFS11-2110,2150PM	245	395	60	205	375	5.5	9.5	11	47	293
EMFS11-4049EZ	49	VFS11-4110,4150PL	245	395	60	205	375	5.5	9.5	11	17	104
EMFS11-4049EZ	49	VFS11-4110,4150PL	245	395	60	205	375	5.5	9.5	11	17	104

Note 1) These values are referential ones of single piece of RFI filter. For 240V class, 60Hz/200V power source. For 500V class, 60Hz/400V power source. For power system A and B, refer to table below.

Select an earth leakage breaker with consideration of leakage current above and leakage current from the inverter unit.

How to wire

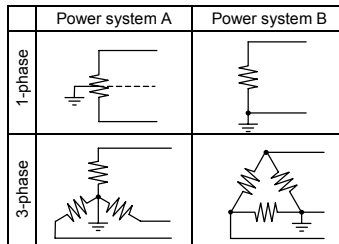
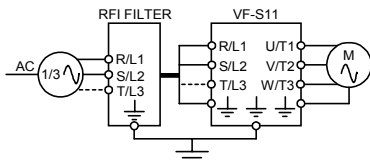

Note 2) For 600V models compliant with EU standards, contact your nearest Toshiba inverter distributor.

10

Devices  
Braking resistor

External dimensions and connections

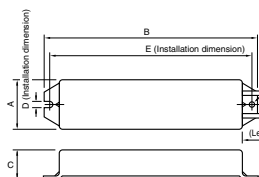

Fig. A

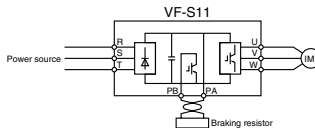

Fig. C

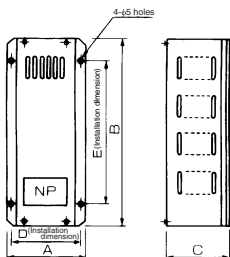

Fig. B

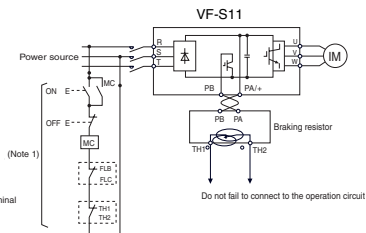

Fig. D

Model	Rating	Inverter type	Dimensions (mm)					External dimensions and connections	Approx. weight (kg)	
			A	B	C	D	E			G
PBR-2007	120W-200Ω	VFS11-2002 - 2007PM VFS11S-2002 - 2007PL	42	182	20	4.2	172	-	A and C	0.28
PBR-2022	120W-75Ω	VFS11-2015, 2022PM VFS11S-2015, 2022PL								
PBR-2037	120W-40Ω	VFS11-2037PM								
PBR3-2055	240W-20Ω (40Ω×2P)	VFS11-2055PM								
PBR3-2075	440W-15Ω (120Ω×2P)	VFS11-2075PM	120	320	115	-	50	B and D	4	
PBR3-2110	660W-10Ω (30Ω×3P)	VFS11-2110PM								
PBR3-2150	880W-7.5Ω (30Ω×4P)	VFS11-2150PM								
PBR-2007	120W-200Ω	VFS11-4004 - 4022PL								
PBR-4037	120W-160Ω	VFS11-4037PL	42	182	20	4.2	172	-	A and C	0.28
PBR3-4055	240W-80Ω (160Ω×2P)	VFS11-4055PL								
PBR3-4075	440W-60Ω (120Ω×2P)	VFS11-4075PL								
PBR3-4110	660W-40Ω (120Ω×3P)	VFS11-4110PL								
PBR3-4150	880W-30Ω (120Ω×4P)	VFS11-4150PL	120	350	190	110	230	150	B and D	4
PBR3-4075	440W-60Ω (120Ω×2P)	VFS11-4075PL								
PBR3-4110	660W-40Ω (120Ω×3P)	VFS11-4110PL								
PBR3-4150	880W-30Ω (120Ω×4P)	VFS11-4150PL								

Note1: Use the same type of braking resistor of VFS11-2002 ~ 2007PM for those of VFS11-4004 ~ 4022PL.

Note2: The data in Rating above refer to the resultant resistance capacities (watts) and resultant resistance values (Ω).

The numeric values inside parentheses refer to the internal compositions of resistors.

The resistances in the Rating column are combined resistances. The numeric values inside parentheses refer to the compositions of resistors (resistance of each resistor x number of resistors).

Devices	External dimensions and connections																																																																										
Motor – end surge voltage suppression filter	<p><b>External dimensions</b></p> <p>4-φ12 holes</p> <p>Name plate</p> <p>Wire opening</p>	<p><b>Connections</b></p> <p>VF-S11</p> <p>Power source</p> <p>Motor-end surge voltage suppression filter</p>																																																																									
	<p>■ Measures to protect motors against surge voltages</p> <p>In a system in which a 400V-class general-purpose motor is operated with a voltage PMW inverter that uses an ultra high-speed switching device (such as an IGBT), surge voltages may be produced and deteriorate the insulation of motor coils, depending on the cable length, wiring method, cable constant, and so on. Here are some examples of measures against surge voltages.</p> <p>(1) Use motors with a high dielectric strength.                      (2) To suppress surge voltages, install an AC reactor (an input reactor may be used instead. For the application, contact your Toshiba dealer) or a surge suppression filter on the output side of the inverter.</p>																																																																										
	<table border="1"> <thead> <tr> <th rowspan="2"></th> <th rowspan="2"></th> <th colspan="8">Dimensions (mm)</th> <th rowspan="2"></th> <th rowspan="2"></th> <th rowspan="2"></th> </tr> <tr> <th>A</th> <th>B</th> <th>C</th> <th>D</th> <th>E</th> <th>F</th> <th>G</th> <th></th> </tr> </thead> <tbody> <tr> <td>MSF-4015Z</td> <td>0.4, 0.75, 1.5</td> <td>310</td> <td>255</td> <td>300</td> <td>200</td> <td>270</td> <td>55</td> <td>189</td> <td></td> <td>M4</td> <td>M4</td> <td>12</td> </tr> <tr> <td>MSF-4037Z</td> <td>2.2, 4.0</td> <td>310</td> <td>255</td> <td>300</td> <td>200</td> <td>270</td> <td>55</td> <td>209</td> <td></td> <td>M4</td> <td>M4</td> <td>20</td> </tr> <tr> <td>MSF-4075Z</td> <td>5.5, 7.5</td> <td>310</td> <td>315</td> <td>350</td> <td>200</td> <td>320</td> <td>55</td> <td>249</td> <td></td> <td>M5</td> <td>M5</td> <td>30</td> </tr> <tr> <td>MSF-4150Z</td> <td>11, 15</td> <td>330</td> <td>350</td> <td>400</td> <td>200</td> <td>370</td> <td>65</td> <td>289</td> <td></td> <td>M5</td> <td>M5</td> <td>40</td> </tr> </tbody> </table>				Dimensions (mm)											A	B	C	D	E	F	G		MSF-4015Z	0.4, 0.75, 1.5	310	255	300	200	270	55	189		M4	M4	12	MSF-4037Z	2.2, 4.0	310	255	300	200	270	55	209		M4	M4	20	MSF-4075Z	5.5, 7.5	310	315	350	200	320	55	249		M5	M5	30	MSF-4150Z	11, 15	330	350	400	200	370	65	289		M5	M5	40
		Dimensions (mm)																																																																									
		A	B	C	D	E	F	G																																																																			
MSF-4015Z	0.4, 0.75, 1.5	310	255	300	200	270	55	189		M4	M4	12																																																															
MSF-4037Z	2.2, 4.0	310	255	300	200	270	55	209		M4	M4	20																																																															
MSF-4075Z	5.5, 7.5	310	315	350	200	320	55	249		M5	M5	30																																																															
MSF-4150Z	11, 15	330	350	400	200	370	65	289		M5	M5	40																																																															
DIN rail kit	DIN003Z	DIN005Z																																																																									
	<p>72</p> <p>130</p> <p>14</p> <p>2.0</p> <p>1.5</p> <p>77</p>	<p>105</p> <p>130</p> <p>14</p> <p>2.5</p> <p>1.5</p> <p>110</p>																																																																									
	<table border="1"> <thead> <tr> <th>Model</th> <th>Inverter type</th> <th>Approx. weight (kg)</th> </tr> </thead> <tbody> <tr> <td>DIN003Z</td> <td>VFS11S-2002PL~2007PL VFS11-2002PM~2007PM</td> <td>0.2</td> </tr> <tr> <td>DIN005Z</td> <td>VFS11S-2015PL, VFS11-2015PM, 2022PM VFS11-4004PL~4015PL, VFS11-6007P, 6015P</td> <td>0.3</td> </tr> </tbody> </table>		Model	Inverter type	Approx. weight (kg)	DIN003Z	VFS11S-2002PL~2007PL VFS11-2002PM~2007PM	0.2	DIN005Z	VFS11S-2015PL, VFS11-2015PM, 2022PM VFS11-4004PL~4015PL, VFS11-6007P, 6015P	0.3																																																																
Model	Inverter type	Approx. weight (kg)																																																																									
DIN003Z	VFS11S-2002PL~2007PL VFS11-2002PM~2007PM	0.2																																																																									
DIN005Z	VFS11S-2015PL, VFS11-2015PM, 2022PM VFS11-4004PL~4015PL, VFS11-6007P, 6015P	0.3																																																																									

Devices	External dimensions and connections	
Parameter writer Parameter writer type: PWU001Z Cable type (1m): CAB0011 (3m): CAB0013 (5m): CAB0015		
Extension panel Extension panel type: RKP001Z Cable type (1m): CAB0011 (3m): CAB0013 (5m): CAB0015		
RS485 communication converter unit • 2-port type: RS4001Z	<div style="display: flex; justify-content: space-around;"> <div data-bbox="218 749 546 1159"> <p>• 2-port type: RS4001Z</p> </div> <div data-bbox="546 749 1009 1159"> <p>• 8-port type: RS4002Z</p> </div> </div> <p style="text-align: center;">Cable type (1m): CAB0011, (3m): CAB0013, (5m): CAB0015</p>	

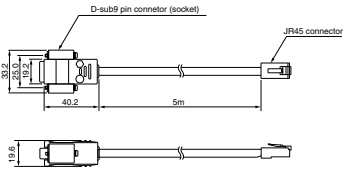
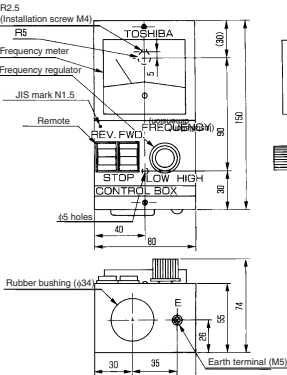
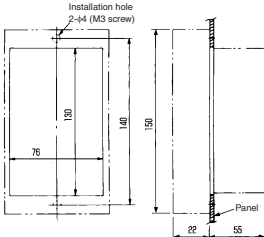
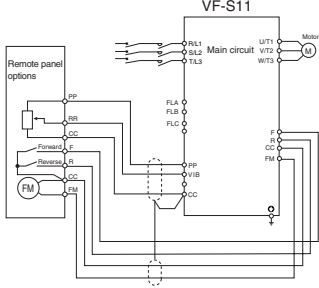
Devices	External dimensions and connections
RS232C communicati on converter cable	
Remote panel CBVR-7B1	<div style="display: flex; justify-content: space-between;"> <div style="width: 45%;">  <p>Painting: JIS mark 5Y711 (Panel front N1.5) Weight: 0.7kg</p> </div> <div style="width: 45%;"> <p style="text-align: center;"><b>Panel hole</b></p>  <p style="text-align: center;"><b>VF-S11</b></p>  <p>Note: The wire length should be 30m or less between the inverter and the remote panel.</p> </div> </div>

# 11. Table of parameters and data

## 11.1 User parameters

Title	Function	Unit	Minimum setting unit Panel/Communication	Adjustment range	Default setting	User setting	Reference
F $\zeta$	Operation frequency of operation panel	Hz	0.1/0.01	L L -U L	0.0		3.2

## 11.2 Basic parameters

### • Four navigation functions

Title	Communication No.	Function	Unit	Minimum setting unit Panel/Communication	Adjustment range	Default setting	User setting	Reference
R $U$ H	-	History function	-	-	Displays parameters in groups of five in the reverse order to that in which their settings were changed. * (Possible to edit)	-		4.1.4
R $U$ 1	0000	Automatic acceleration/deceleration	-	-	0: Disabled (manual) 1: Automatic 2: Automatic (only at acceleration)	0		5.1.1
R $U$ 2	0001	Torque boost setting macro function	-	-	0: Disabled 1: Automatic torque boost + auto-tuning 2: Vector control + auto-tuning 3: Energy saving + auto-tuning	0		5.2
R $U$ 4	0040	Parameter setting macro function	-	-	0: Disabled 1: Coast stop 2: 3-wire operation 3: External input UP/DOWN setting 4: 2-20 mA current input operation	0		5.3

### • Basic parameters

Title	Communication No.	Function	Unit	Minimum setting unit Panel/Communication	Adjustment range	Default setting	User setting	Reference
C $R$ Gd	0003	Command mode selection	-	-	0: Terminal board 1: Operation panel	1		5.4 7.2
F $R$ Gd	0004	Frequency setting mode selection 1	-	-	0: Built-in potentiometer 1: VIA 2: VIB 3: Operation panel 4: Serial communication 5: UP/DOWN from external contact 6: VIA + VIB (Override)	0		5.4 6.5.1 7.1

Title	Communication No.	Function	Unit	Minimum setting unit Panel/Communication	Adjustment range	Default setting	User setting	Reference
<i>F<sub>FL</sub>L</i>	0005	Meter selection	-	-	0: Output frequency 1: Output current 2: Set frequency 3: DC voltage 4: Output voltage command value 5: Input power 6: Output power 7: Torque 8: Torque current 9: Motor cumulative load factor 10: Inverter cumulative load factor 11: PBR (braking reactor) cumulative load factor 12: Frequency setting value (after PID) 13: V/A Input value 14: V/B Input value 15: Fixed output 1 (Output current: 100%) 16: Fixed output 2 (Output current: 50%) 17: Fixed output 3 (Other than the output current: 100%) 18: Serial communication data 19: For adjustments ( <i>F<sub>FL</sub></i> set value is displayed.)	0		5.5
<i>F<sub>FL</sub></i>	0006	Meter adjustment	-	-	-	-		5.5
<i>LSP</i>	0007	Default setting	-	-	0: - 1: 50Hz default setting 2: 60Hz default setting 3: Default setting (Initialization) 4: Trip record clear 5: Cumulative operation time clear 6: Initialization of type information 7: Save user setting parameters 8: Load user setting parameters 9: Cumulative fan operation time record clears	0		4.2.6 4.2.7 5.6
<i>F<sub>r</sub></i>	0008	Forward/reverse run selection (Operation panel)	-	-	0: Forward run 1: Reverse run 2: Forward run (F/R switching possible) 3: Reverse run (F/R switching possible)	0		5.7
<i>ACC</i>	0009	Acceleration time <sub>1</sub>	S	0.1/0.1	0.0-3200	10.0		5.1.2
<i>DEC</i>	0010	Deceleration time <sub>1</sub>	S	0.1/0.1	0.0-3200	10.0		5.1.2
<i>FH</i>	0011	Maximum frequency	Hz	0.1/0.01	30.0-500.0	80.0		5.8
<i>UL</i>	0012	Upper limit frequency	Hz	0.1/0.01	0.5- <i>FH</i>	50.0 (WP) 60.0 (WN_AN)		5.9
<i>LL</i>	0013	Lower limit frequency	Hz	0.1/0.01	0.0- <i>UL</i>	0.0		5.9
<i>ωL</i>	0014	Base frequency 1	Hz	0.1/0.01	25-500.0	50.0 (WP) 60.0 (WN_AN)		5.10
<i>ωL<sub>v</sub></i>	0409	Base frequency voltage 1	V	1/0.1	50-330 (240V class) 50-660 (500/600V class)	*3		5.10 6.13.6

\*3 : 230 (240V class), 460 (500V class), 575V (600V class)

Title	Communication No.	Function	Unit	Minimum setting unit Panel/Communication	Adjustment range	Default setting	User setting	Reference																															
$P \xi$	0015	V/F control mode selection	-	-	0: V/F constant 1: Variable torque 2: Automatic torque boost control 3: Vector control 4: Energy-saving 5: Dynamic energy-saving (for fans and pumps) 6: PM motor control	2		5.11																															
$u b$	0016	Torque boost value 1	%	0.1/0.1	0.0-30.0	* 1		5.12																															
$\xi H r$	0600	Motor electronic-thermal protection level 1	% (A)	1/1	10-100	100		5.13 6.19.1																															
$\xi L n$	0017	Electronic-thermal protection characteristic selection *2	-	-	<table border="1"> <thead> <tr> <th>Setting</th> <th></th> <th>Overload protection</th> <th>OL stall</th> </tr> </thead> <tbody> <tr> <td>0</td> <td rowspan="3">Standard motor</td> <td>○</td> <td>×</td> </tr> <tr> <td>1</td> <td>○</td> <td>○</td> </tr> <tr> <td>2</td> <td>×</td> <td>×</td> </tr> <tr> <td>3</td> <td rowspan="4">VF motor</td> <td>×</td> <td>○</td> </tr> <tr> <td>4</td> <td>○</td> <td>×</td> </tr> <tr> <td>5</td> <td>○</td> <td>○</td> </tr> <tr> <td>6</td> <td>×</td> <td>×</td> </tr> <tr> <td>7</td> <td></td> <td>×</td> <td>○</td> </tr> </tbody> </table>	Setting		Overload protection	OL stall	0	Standard motor	○	×	1	○	○	2	×	×	3	VF motor	×	○	4	○	×	5	○	○	6	×	×	7		×	○	0		5.13
Setting		Overload protection	OL stall																																				
0	Standard motor	○	×																																				
1		○	○																																				
2		×	×																																				
3	VF motor	×	○																																				
4		○	×																																				
5		○	○																																				
6		×	×																																				
7		×	○																																				
$S r 1$	0018	Preset-speed operation frequency 1	Hz	0.1/0.01	$L L - U L$	0.0		5.14																															
$S r 2$	0019	Preset-speed operation frequency 2	Hz	0.1/0.01	$L L - U L$	0.0																																	
$S r 3$	0020	Preset-speed operation frequency 3	Hz	0.1/0.01	$L L - U L$	0.0																																	
$S r 4$	0021	Preset-speed operation frequency 4	Hz	0.1/0.01	$L L - U L$	0.0																																	
$S r 5$	0022	Preset-speed operation frequency 5	Hz	0.1/0.01	$L L - U L$	0.0																																	
$S r 6$	0023	Preset-speed operation frequency 6	Hz	0.1/0.01	$L L - U L$	0.0																																	
$S r 7$	0024	Preset-speed operation frequency 7	Hz	0.1/0.01	$L L - U L$	0.0																																	
$F - - -$	-	Extended parameters	-	-	-	-	-	4.1.2																															
$G r - U$	-	Automatic edit function	-	-	-	-	-	4.1.3																															

\*1 : Default values vary depending on the capacity. See the table of the page K-15.

\*2 : ○ : valid, × : invalid

## 11.3 Extended parameters

- Input/output parameters 1

Title	Communication No.	Function	Unit	Minimum setting unit Panel/Communication	Adjustment range	Default setting	User setting	Reference
F 1 0 0	0100	Low-speed signal output frequency	Hz	0.1/0.01	0.0-F H	0.0		6.1.1
F 1 0 1	0101	Speed reach setting frequency	Hz	0.1/0.01	0.0-F H	0.0		6.1.3
F 1 0 2	0102	Speed reach detection band	Hz	0.1/0.01	0.0-F H	2.5		6.1.2
F 1 0 5	0105	Priority selection (Both F-CC and R-CC are ON)	-	-	0: Reverse 1: Slowdown Stop	1		6.2.1
F 1 0 8	0108	Always active function selection 1	-	-	0-65 (No function)	0		6.3.1
F 1 0 9	0109	Analog/contact input function selection (VIA/VIB terminal)	-	-	0: Analog input for communications VIB - analog input ----- 1: VIA - analog input VIB - contact input (Sink) ----- 2: VIA - analog input VIB - contact input (Source) ----- 3: VIA - contact input (Sink) VIB - contact input (Sink) ----- 4: VIA - contact input (Source) VIB - contact input (Source)	0		6.2.2
F 1 1 0	0110	Always-active function selection 2	-	-	0-65 (ST)	1		6.3.1
F 1 1 1	0111	Input terminal selection 1 (F)	-	-	0-65 (F)	2		6.3.2
F 1 1 2	0112	Input terminal selection 2 (R)	-	-	0-65 (R)	3		
F 1 1 3	0113	Input terminal selection 3 (RES)	-	-	0-65 (RES)	10		
F 1 1 4	0114	Input terminal selection 4 (S1)	-	-	0-65 (SS1)	6		
F 1 1 5	0115	Input terminal selection 5 (S2)	-	-	0-65 (SS2)	7		
F 1 1 6	0116	Input terminal selection 6 (S3)	-	-	0-65 (SS3)	8		
F 1 1 7	0117	Input terminal selection 7 (VIB)	-	-	5-17 (SS4)	9		
F 1 1 8	0118	Input terminal selection 8 (VIA)	-	-	5-17 (AD2)	5		
F 1 3 0	0130	Output terminal selection 1A (RY-RC)	-	-	0-255 (LOW)	4		6.3.3
F 1 3 1	0131	Output terminal selection 2A (OUT-NO)	-	-	0-255 (RCH)	6		
F 1 3 2	0132	Output terminal selection 3 (FL)	-	-	0-255 (FL)	10		
F 1 3 7	0137	Output terminal selection 1B (RY-RC)	-	-	0-255 (always ON)	255		
F 1 3 8	0138	Output terminal selection 2B (OUT-NO)	-	-	0-255 (always ON)	255		6.3.4

Title	Communication No.	Function	Unit	Minimum setting unit Panel/Communication	Adjustment range	Default setting	User setting	Reference
F139	0139	Output terminal logic selection (RY-RC, OUT-NO)	-	-	0: F130 and F137 F131 and F138 1: F130 or F137 F131 and F138 2: F130 and F137 F131 or F138 3: F130 or F137 F131 or F138	0		6.3.4
F167	0167	Frequency command agreement detection range	Hz	0.1/0.01	0.0-FH	2.5		6.3.5
F170	0170	Base frequency 2	Hz	0.1/0.01	25.0-500.0	50.0 (WP) 60.0 (WN, AN)		6.4.1
F171	0171	Base frequency voltage 2	V	1/0.1	50-330 (240V class) 50-660 (500/600V class)	* 3		
F172	0172	Torque boost value 2	%	0.1/0.1	0.0-30.0	* 1		
F173	0173	Motor electronic-thermal protection level 2	% (A)	1/1	10-100	100		5.13 6.4.1
F185	0185	Stall prevention level 2	% (A)	1/1	10-199, 200 (disabled)	150		6.4.1 6.19.2

\*1 : Default values vary depending on the capacity. See the table of page K-15.

\*3 : 230 (240V class), 460 (500V class), 575 (600V class)

### • Frequency parameters

Title	Communication No.	Function	Unit	Minimum setting unit Panel/Communication	Adjustment range	Default setting	User setting	Reference
F200	0200	Frequency priority selection	-	-	0: F200 (Switchable to F207 by terminal input) 1: F200 (Switchable to F207 at less than 1.0Hz of designated frequency)	0		6.5.1 7.1
F201	0201	VIA input point 1 setting	%	1/1	0-100	0		6.5.2
F202	0202	VIA input point 1 frequency	Hz	0.1/0.01	0.0-500.0	0.0		
F203	0203	VIA input point 2 setting	%	1/1	0-100	100		
F204	0204	VIA input point 2 frequency	Hz	0.1/0.01	0.0-500.0	50.0 (WP) 60.0 (WN, AN)		
F207	0207	Frequency setting mode selection 2	-	-	0: Built-in potentiometer 1: VIA 2: VIB 3: Operation panel 4: Serial communication 5: UP/DOWN from external contact 6: VIA + VIB (Override)	1		6.3.5 6.5.1 7.1

Title	Communication No.	Function	Unit	Minimum setting unit Panel/Communication	Adjustment range	Default setting	User setting	Reference
F210	0210	VIB input point 1 setting	%	1/1	0-100	0		6.5.2
F211	0211	VIB input point 1 frequency	Hz	0.1/0.01	0.0-500.0	0.0		
F212	0212	VIB input point 2 setting	%	1/1	0-100	100		
F213	0213	VIB input point 2 frequency	Hz	0.1/0.01	0.0-500.0	50.0 (WP) 60.0 (WN, AN)		
F240	0240	Starting frequency setting	Hz	0.1/0.01	0.5-10.0	0.5		6.6.1
F241	0241	Operation starting frequency	Hz	0.1/0.01	0.0-FH	0.0		6.6.2
F242	0242	Operation starting frequency hysteresis	Hz	0.1/0.01	0.0-FH	0.0		6.6.2
F250	0250	DC braking starting frequency	Hz	0.1/0.01	0.0-FH	0.0		6.7.1
F251	0251	DC braking current	%(A)	1/1	0-100	50		
F252	0252	DC braking time	s	0.1/0.1	0.0-20.0	1.0		6.7.2
F254	0254	Motor shaft fixing control	-	-	0: Disabled 1: Enabled (after DC braking)	0		
F256	0256	Time limit for lower-limit frequency operation	s	0.1/0.1	0: Disabled 0.1-600.0	0.0		6.8
F260	0260	Jog run frequency	Hz	0.1/0.01	F240 - 20.0	5.0		6.9
F261	0261	Jog run stopping pattern	-	-	0: Slowdown stop 1: Coast stop 2: DC braking	0		
F262	0262	Panel jog run operation mode	-	-	0: Invalid 1: Valid	0		
F264	0264	Input from external contacts - UP response time	s	0.1/0.1	0.0-10.0	0.1		
F265	0265	Input from external contacts - UP frequency step width	Hz	0.1/0.01	0.0-FH	0.1		6.5.2
F266	0266	Input from external contacts - DOWN response time	s	0.1/0.1	0.0-10.0	0.1		
F267	0267	Input from external contacts - DOWN frequency step width	Hz	0.1/0.01	0.0-FH	0.1		
F268	0268	Initial value of UP/DOWN frequency	Hz	0.1/0.01	L - UL	0.0		
F269	0269	Saving of changed value of UP/DOWN frequency	-	-	0: Not changed 1: Setting of F268 changed when power is turned off	1		
F270	0270	Jump frequency 1	Hz	0.1/0.01	0.0-FH	0.0		6.10
F271	0271	Jumping width 1	Hz	0.1/0.01	0.0-30.0	0.0		
F272	0272	Jump frequency 2	Hz	0.1/0.01	0.0-FH	0.0		

Title	Communication No.	Function	Unit	Minimum setting unit Panel/Communication	Adjustment range	Default setting	User setting	Reference
F273	0273	Jumping width 2	Hz	0.1/0.01	0.0-30.0	0.0		6.10
F274	0274	Jump frequency 3	Hz	0.1/0.01	0.0-FH	0.0		
F275	0275	Jumping width 3	Hz	0.1/0.01	0.0-30.0	0.0		
F287	0287	Preset-speed operation frequency 8	Hz	0.1/0.01	LL-UL	0.0		5.14
F288	0288	Preset-speed operation frequency 9	Hz	0.1/0.01	LL-UL	0.0		
F289	0289	Preset-speed operation frequency 10	Hz	0.1/0.01	LL-UL	0.0		
F290	0290	Preset-speed operation frequency 11	Hz	0.1/0.01	LL-UL	0.0		
F291	0291	Preset-speed operation frequency 12	Hz	0.1/0.01	LL-UL	0.0		
F292	0292	Preset-speed operation frequency 13	Hz	0.1/0.01	LL-UL	0.0		
F293	0293	Preset-speed operation frequency 14	Hz	0.1/0.01	LL-UL	0.0		
F294	0294	Preset-speed operation frequency 15 (Fire-speed)	Hz	0.1/0.01	LL-UL	0.0		

• Operation mode parameters

Title	Communication No.	Function	Unit	Minimum setting unit Panel/Communication	Adjustment range	Default setting	User setting	Reference
F300	0300	PWM carrier frequency	kHz	0.1/0.1	2.0 - 16.0	12.0		6.12
F301	0301	Auto-restart control selection	-	-	0: Disabled 1: At auto-restart after momentary stop 2: ST terminal on or off 3: At auto-restart or when turning ST-CC on or off 4: At start-up	0		6.13.1
F302	0302	Regenerative power ride-through control (Deceleration stop)	-	-	0: Disabled 1: Automatic setting 2: Slowdown stop	0		6.13.2
F303	0303	Retry selection (number of times)	Times	1/1	0: Disabled 1-10	0		6.13.3
F304	0304	Dynamic braking selection	-	-	0: Disabled 1: Enabled (Resistor overload protection enabled)	0		6.13.4
F305	0305	Overvoltage limit operation (Slowdown stop mode selection)	-	-	0: Enabled 1: Disabled 2: Enabled (Quick deceleration) 3: Enabled (Dynamic quick deceleration)	2		6.13.5

Title	Communication No.	Function	Unit	Minimum setting unit Panel/Communication	Adjustment range	Default setting	User setting	Reference
F307	0307	Supply voltage correction (limitation of output voltage)	-	-	0: Supply voltage uncorrected, output voltage limited 1: Supply voltage corrected, output voltage limited 2: Supply voltage uncorrected, output voltage unlimited 3: Supply voltage corrected, output voltage unlimited	2 (WP, WN) 3 (AN)		6.13.6
F308	0308	Dynamic braking resistance	$\Omega$	0.1/0.1	1.0-1000	* 1		6.13.4
F309	0309	Dynamic braking resistor capacity	kW	0.01/0.01	0.01-30.00	* 1		6.13.4
F311	0311	Reverse-run prohibition	-	-	0: Forward/reverse run permitted 1: Reverse run prohibited 2: Forward run prohibited	0		6.13.7
F312	0312	Random mode	-	-	0: Disabled 1: Automatic setting	0		6.12
F316	0316	Carrier frequency control mode selection	-	-	0: Carrier frequency not reduced automatically 1: Carrier frequency reduced automatically 2: Carrier frequency not reduced automatically Support for 500V/600V models 3: Carrier frequency reduced automatically Support for 500V/600V models	1		6.12
F320	0320	Droop gain	%	1/1	0-100	0		6.14
F323	0323	Droop insensitive torque band	%	1/1	0-100	10		6.14
F342	0342	Braking mode selection	-	-	0: Disabled 1: Enabled (forward run) 2: Enabled (reverse run) 3: Enabled (operating direction)	0		6.15
F343	0343	Release frequency	Hz	0.1/0.01	F240-20.0	3.0		
F344	0344	Release time	s	0.01/0.01	0.00-2.50	0.05		
F345	0345	Creeping frequency	Hz	0.1/0.01	F240-20.0	3.0		
F346	0346	Creeping time	s	0.01/0.01	0.00-2.50	0.10		
F359	0359	PID control waiting time	s	1/1	0-2400	0		6.16
F360	0360	PID control	-	-	0: Disabled, 1: Enabled	0		
F362	0362	Proportional gain	-	0.01/0.01	0.01-100.0	0.30		
F363	0363	Integral gain	-	0.01/0.01	0.01-100.0	0.20		
F366	0366	Differential gain	-	0.01/0.01	0.00-2.5	0.00		

\*1 : Default values vary depending on the capacity. See the table of K-15.

• Torque boost parameters 1

Title	Communication No.	Function	Unit	Minimum setting unit Panel/Communication	Adjustment range	Default setting	User setting	Reference
F400	0400	Auto-tuning	-	-	0: Auto-tuning disabled	0		5.11 6.17.1
					1: Initialization of F402 (reset to 0)			
					2: Auto-tuning enabled (after execution: 0)			
F401	0401	Slip frequency gain	%	1/1	0-150	50		
F402	0402	Automatic torque boost value	%	0.1/0.1	0.0-30.0	*1		
F415	0415	Motor rated current	A	0.1/0.1	0.1-100.0	*1		
F416	0416	Motor no-load current	%	1/1	10-90	*1		
F417	0417	Motor rated speed	min-1	1/1	100-32000	1410(WP) 1710 (WN, AN)		
F418	0418	Speed control response coefficient	-	1/1	1-150	40		
F419	0419	Speed control stability coefficient	-	1/1	1-100	20		

\*1 : Default values vary depending on the capacity. See the table of page K-15.

• Input/output parameters 2

Title	Communication No.	Function	Unit	Minimum setting unit Panel/Communication	Adjustment range	Default setting	User setting	Reference
F470	0470	VIA input bias	-	-	-	-		6.5.4
F471	0471	VIA input gain	-	-	-	-		
F472	0472	VIB input bias	-	-	-	-		
F473	0473	VIB input gain	-	-	-	-		

• Torque boost parameters 2

Title	Communication No.	Function	Unit	Minimum setting unit Panel/Communication	Adjustment range	Default setting	User setting	Reference
F480	0480	Exciting current coefficient	%	1/1	100-130	100		5.11 6.17.2
F485	0485	Stall prevention control coefficient 1	-	1/1	10-250	100		
F492	0492	Stall prevention control coefficient 2	-	1/1	50-150	100		
F494	0494	Motor adjustment coefficient	-	1/1	0-200	*1		
F495	0495	Maximum voltage adjustment coefficient	%	1/1	90-110	104		
F496	0496	Waveform switching adjustment coefficient	kHz	0.1/0.01	0.1-14.0	0.2		

\*1 : Default values vary depending on the capacity. See the table of page K-15.

• Acceleration/deceleration time parameters

Title	Communication No.	Function	Unit	Minimum setting unit Panel/Communication	Adjustment range	Default setting	User setting	Reference
F500	0500	Acceleration time 2	s	0.1/0.1	0.0-3200	10.0		6.18
F501	0501	Deceleration time 2	s	0.1/0.1	0.0-3200	10.0		
F502	0502	Acceleration/deceleration 1 pattern	-	-	0: Linear 1: S-pattern 1	0		
F503	0503	Acceleration/deceleration 2 pattern	-	-	2: S-pattern 2	0		
F504	0504	Acceleration/deceleration selection (1, 2, 3)	-	-	1: Acceleration/deceleration 1 2: Acceleration/deceleration 2 3: Acceleration/deceleration 3	1		
F505	0505	Acceleration/deceleration 1 and 2 switching frequency	Hz	0.1/0.01	0.0- $\bar{U}$	0.0		
F506	0506	S-pattern lower-limit adjustment amount	%	1/1	0-50	10		
F507	0507	S-pattern upper-limit adjustment amount	%	1/1	0-50	10		
F510	0510	Acceleration time 3	s	0.1/0.1	0.0-3200	10.0		
F511	0511	Deceleration time 3	s	0.1/0.1	0.0-3200	10.0		
F512	0512	Acceleration/deceleration 3 pattern	-	-	0: Linear 1: S-pattern 1 2: S-pattern 2	0		
F513	0513	Acceleration/deceleration 2 and 3 switching frequency	Hz	0.1/0.01	0.0- $\bar{U}$	0.0		

• Protection parameters

Title	Communication No.	Function	Unit	Minimum setting unit Panel/Communication	Adjustment range	Default setting	User setting	Reference
F601	0601	Stall prevention level 1	% (A)	1/1	10-199, 200 (disabled)	150		6.19.2
F602	0602	Inverter trip retention selection	-	-	0: Canceled with the power off 1: Still retained with the power off	0		6.19.3
F603	0603	Emergency stop selection	-	-	0: Coast stop 1: Slowdown stop 2: Emergency DC braking	0		6.19.4
F604	0604	Emergency DC braking time	s	0.1/0.1	0.0-20.0	1.0		6.19.4
F605	0605	Output phase failure detection mode selection	-	-	0: Disabled 1: At start-up (only one time after power is turned on) 2: At start-up (each time) 3: During operation 4: At start-up + during operation 5: Detection of cutoff on output side	0		6.19.5
F607	0607	Motor 150%-overload time limit	s	1/1	10-2400	300		6.19.1
F608	0608	Input phase failure detection mode selection	-	-	0: Disabled, 1: Enabled	1		6.19.6

Title	Communication No.	Function	Unit	Minimum setting unit Panel/Communication	Adjustment range	Default setting	User setting	Reference
F609	0609	Small current detection current hysteresis	%	1/1	1-20	10		6.19.7
F610	0610	Small current trip/alarm selection	-	-	0: Alarm only 1: Tripping	0		
F611	0611	Small current detection current	% (A)	1/1	0-100	0		
F612	0612	Small current detection time	s	1/1	0-255	0		6.19.8
F613	0613	Detection of output short-circuit during start-up	-	-	0: Each time (standard pulse) 1: At start-up (only one time after power is turned on) (standard pulse) 2: Each time (short-time pulse) 3: At start-up (only one time after power is turned on) (short-time pulse)	0		
F615	0615	Over-torque trip/alarm selection	-	-	0: Alarm only 1: Tripping	0		
F616	0616	Over-torque detection level	%	1/1	0-250	150		6.19.9
F618	0618	Over-torque detection time	s	0.1/0.1	0.0-10.0	0.5		
F619	0619	Over-torque detection level hysteresis	%	1/1	0-100	10		
F621	0621	Cumulative operation time alarm setting	100 Time	0.1/0.1 (=10 hours)	0.0-999.9	610		6.19.10
F626	0626	Over-voltage stall protection level	%	1/1	100-150	*1		6.13.5
F627	0627	Undervoltage trip/alarm selection	-	-	0: Alarm only (detection level below 60%) 1: Tripping (detection level below 60%) 2: Alarm only (detection level below 50%, DC reactor necessary)	0		6.19.12
F633	0633	Trip at VIA low level input mode	%	1/1	0: Disabled, 1-100	0		6.19.13
F634	0634	Annual average ambient temperature (parts replacement alarms)	-	-	1: -10 to +10°C 2: 11-20°C 3: 21-30°C 4: 31-40°C 5: 41-50°C 6: 51-60°C	3		6.19.14

\*1 : Default values vary depending on the capacity. See the table of K-15.

• Output parameters

Title	Communication No.	Function	Unit	Minimum setting unit Panel/Communication	Adjustment range	Default setting	User setting	Reference
F 6 6 9	0669	Logic output/pulse train output selection (OUT-NO)	-	-	0: Logic output 1: Pulse train output	0		6.20.1
F 6 7 6	0676	Pulse train output function selection (OUT-NO)	-	-	0: Output frequency 1: Output current 2: Set frequency 3: DC voltage 4: Output voltage command value 5: Input power 6: Output power 7: Torque 8: Torque current 9: Motor cumulative load factor 10: Inverter cumulative load factor 11: PBR (braking reactor) cumulative load factor 12: Frequency setting value (after PID) 13: VI/II Input value 14: VIB Input value 15: Fixed output 1 (Output current: 100%) 16: Fixed output 2 (Output current: 50%) 17: Fixed output 3 (Other than the output current: 100%)	0		6.20.1
F 6 7 7	0677	Maximum numbers of pulse train	pps	1/1	500-1600	800		6.20.1
F 6 9 1	0691	Inclination characteristic of analog output	-	-	0: Negative inclination (downward slope) 1: Positive inclination (upward slope)	1		6.20.2
F 6 9 2	0692	Meter bias	%	1/1	0-100	0		6.20.2

• Operation panel parameters

Title	Communication No.	Function	Unit	Minimum setting unit Panel/Communication	Adjustment range	Default setting	User setting	Reference
F 7 0 0	0700	Prohibition of change of parameter settings	-	-	0: Permitted 1: Prohibited	0		6.21.1
F 7 0 1	0701	Unit selection	-	-	0: % 1: A (ampere)/V (volt)	0		6.21.2
F 7 0 2	0702	Free unit selection	Times	0.01/0.01	0.00: Free unit display disabled (display of frequency) 0.01-200.0	0.00		6.21.3
F 7 0 5	0705	Inclination characteristic of free unit display	-	-	0: Negative inclination (downward slope) 1: Positive inclination (upward slope)	1		
F 7 0 6	0706	Free unit display bias	Hz	0.01/0.01	0.00- <i>F H</i>	0.00		
F 7 0 7	0707	Free step 1 (pressing a panel key once)	Hz	0.01/0.01	0.00: Disabled 0.01- <i>F H</i>	0.00		6.21.4
F 7 0 8	0708	Free step 2 (panel display)	-	1/1	0: Disabled 1-255	0		

Title	Communication No.	Function	Unit	Minimum setting unit Panel/Communication	Adjustment range	Default setting	User setting	Reference
F710	0710	Standard monitor display selection	-	-	0: Operation frequency (Hz/free unit) 1: Frequency command (Hz/free unit) 2: Output current (%A) 3: Inverter rated current (A) 4: Inverter load factor (%) 5: Output power (%) 6: Frequency command after PID control (Hz/free unit) 7: Optional item specified from an external control unit	0		6.21.5
F719	0719	Canceling of operation command when standby terminal (ST) is turned off	-	-	0: Operation command canceled (cleared) 1: Operation command retained	1		6.21.6
F721	0721	Panel stop pattern	-	-	0: Slowdown stop 1: Coast stop	0		6.21.7
F730	0730	Prohibition of frequency setting on the operation panel (F <sub>F</sub> )	-	-	0: Permitted 1: Prohibited	0		6.21.1
F733	0733	Panel operation prohibition (RUN/STOP keys)	-	-	0: Permitted 1: Prohibited	0		
F734	0734	Prohibition of panel emergency stop operation	-	-	0: Permitted 1: Prohibited	0		
F735	0735	Prohibition of panel reset operation	-	-	0: Permitted 1: Prohibited	0		
F736	0736	Prohibition of change of $\int F R G d$ / $F R G d$ during operation	-	-	0: Permitted 1: Prohibited	1		

• Communication parameters

Title	Communication No.	Function	Unit	Minimum setting unit Panel/Communication	Adjustment range	Default setting	User setting	Reference
F800	0800	Communication rate	-	-	0: 1200bps 1: 2400bps 2: 4800bps 3: 9600bps 4: 19200bps	3		6.22
F801	0801	Parity	-	-	0: NON (No parity) 1: EVEN (Even parity) 2: ODD (Odd parity)	1		
F802	0802	Inverter number	-	1/1	0-255	0		
F803	0803	Communication error trip time	s	1/1	0: (disabled) 1-100	0		
F805	0805	Communication waiting time	s	0.01/0.01	0.00-2.00	0.00		
F806	0806	Setting of master and slave for communication between inverters	-	-	0: Slave (0 Hz command issued in case the master inverter fails) 1: Slave (Operation continued in case the master inverter fails) 2: Slave (Emergency stop tripping in case the master inverter fails) 3: Master (transmission of frequency commands) 4: Master (transmission of output frequency signals)	0		

Title	Communication No.	Function	Unit	Minimum setting unit Panel/Communication	Adjustment range	Default setting	User setting	Reference	
F811	0811	Communication command point 1 setting	%	1/1	0-100	0		6.5.2 6.22.1	
F812	0812	Communication command point 1 frequency	Hz	0.1/0.01	0.0-500.0	0.0			
F813	0813	Communication command point 2 setting	%	1/1	0-100	100			
F814	0814	Communication command point 2 frequency	Hz	0.1/0.01	0.0-500.0	50.0 (WP) 60.0 (WN_AN)			
F829	0829	Selection of communication protocol	-	-	0: Toshiba inverter protocol 1: Modbus RTU protocol	0		6.22	
F870	0870	Block write data 1	-	-	0: No selection 1: Command information 1 2: Command information 2 3: Frequency command 4: Output data on the terminal board 5: Analog output for communications	0			
F871	0871	Block write data 2	-	-		0			
F875	0875	Block read data 1	-	-		0			
F876	0876	Block read data 2	-	-		0			
F877	0877	Block read data 3	-	-		0			
F878	0878	Block read data 4	-	-		0			
F879	0879	Block read data 5	-	-		0			
F880	0880	Free notes	-	1/1		0-65535	0		
F890	0890	Parameter for option 1	-	1/1		0-65535	0		
F891	0891	Parameter for option 2	-	1/1		0-65535	0		
F892	0892	Parameter for option 3	-	1/1	0-65535	0			
F893	0893	Parameter for option 4	-	1/1	0-65535	0			
F894	0894	Parameter for option 5	-	1/1	0-65535	0			

• PM motor parameters

Title	Communication No.	Function	Unit	Minimum setting unit Panel/Communication	Adjustment range	Default setting	User setting	Reference
F910	0910	Step-out detection current level	% (A)	1/1	10-150	100		6.24
F911	0911	Step-out detection time	s	1/1	0.0: No detection 0.1-25.0	0.0		
F912	0912	High-speed torque adjustment coefficient	-	0.01/0.01	0.00-650.0	0.00		

### ■ Default settings by inverter rating

Inverter type	Torque boost value 1/2	Dynamic braking resistance	Dynamic braking resistor capacity	Automatic torque boost value	Motor rated current	Motor no-load current	Motor adjustment coefficient	Over-voltage stall protection level
	$\omega b / F 172$ (%)	$F 308$ ( $\Omega$ )(Note)	$F 309$ (kW)	$F 402$ (%)	$F 415$ (A)	$F 416$ (%)	$F 494$	$F 626$ (%)
VFS11S-2002PL	6.0	200.0	0.12	8.3	1.2	70	90	134
VFS11S-2004PL	6.0	200.0	0.12	6.2	2.0	65	90	134
VFS11S-2007PL	6.0	200.0	0.12	5.8	3.4	60	80	134
VFS11S-2015PL	6.0	75.0	0.12	4.3	6.2	55	70	134
VFS11S-2022PL	5.0	75.0	0.12	4.1	8.9	52	70	134
VFS11-2002PM	6.0	200.0	0.12	8.3	1.2	70	90	134
VFS11-2004PM	6.0	200.0	0.12	6.2	2.0	65	90	134
VFS11-2005PM	6.0	200.0	0.12	6.0	2.7	62	80	134
VFS11-2007PM	6.0	200.0	0.12	5.8	3.4	60	80	134
VFS11-2015PM	6.0	75.0	0.12	4.3	6.2	55	70	134
VFS11-2022PM	5.0	75.0	0.12	4.1	8.9	52	70	134
VFS11-2037PM	5.0	40.0	0.12	3.4	14.8	48	70	134
VFS11-2055PM	4.0	20.0	0.24	3.0	21.0	46	70	134
VFS11-2075PM	3.0	15.0	0.44	2.5	28.2	43	70	134
VFS11-2110PM	2.0	10.0	0.66	2.3	40.6	41	60	134
VFS11-2150PM	2.0	7.5	0.88	2.0	54.6	38	50	134
VFS11-4004PL	6.0	200.0	0.12	6.2	1.0	65	90	140
VFS11-4007PL	6.0	200.0	0.12	5.8	1.7	60	80	140
VFS11-4015PL	6.0	200.0	0.12	4.3	3.1	55	70	140
VFS11-4022PL	5.0	200.0	0.12	4.1	4.5	52	70	140
VFS11-4037PL	5.0	160.0	0.12	3.4	7.4	48	70	140
VFS11-4055PL	4.0	80.0	0.24	2.6	10.5	46	70	140
VFS11-4075PL	3.0	60.0	0.44	2.3	14.1	43	70	140
VFS11-4110PL	2.0	40.0	0.66	2.2	20.3	41	60	140
VFS11-4150PL	2.0	30.0	0.88	1.9	27.3	38	50	140
VFS11-6007P	3.0	285.0	0.06	3.8	1.1	61	80	134
VFS11-6015P	3.0	145.0	0.12	3.8	2.1	59	70	134
VFS11-6022P	3.0	95.0	0.18	3.2	3.0	54	70	134
VFS11-6037P	3.0	48.0	0.37	3.5	4.9	50	70	134
VFS11-6055P	2.0	29.0	0.61	2.0	7.3	55	70	134
VFS11-6075P	2.0	29.0	0.61	1.5	9.5	51	70	134
VFS11-6110P	2.0	19.0	0.92	1.9	14.5	55	60	134
VFS11-6150P	1.0	14.0	1.23	1.7	19.3	53	50	134

Note: Be sure to set  $F 308$  (Dynamic braking resistance) at the resistance of the dynamic braking resistor connected.

■ Table of input terminal functions 1

Function No.	Code	Function	Action
0	-	No function is assigned	Disabled
1	ST	Standby terminal	ON: Ready for operation OFF: Coast stop (gate off)
2	F	Forward run command	ON: Forward run OFF: Slowdown stop
3	R	Reverse run command	ON: Reverse run OFF: Slowdown stop
4	JOG	Jog run mode	ON: Jog run, OFF: Jog run canceled
5	AD2	Acceleration/deceleration 2 pattern selection	ON: Acceleration/deceleration 2 OFF: Acceleration/deceleration 1 or 3
6	SS1	Preset-speed command 1	Selection of 15-speed with SS1 to SS4 (4 bits)
7	SS2	Preset-speed command 2	
8	SS3	Preset-speed command 3	
9	SS4	Preset-speed command 4	
10	RES	Reset command	ON: Acceptance of reset command ON → OFF: Trip reset
11	EXT	Trip stop command from external input device	ON: $\bar{E}$ Trip stop
12	CFMOD	Switching of command mode and frequency setting mode	ON: Forced switching from command mode to terminal input mode, forced switching from frequency setting mode to the mode commanded between $F R \bar{O} d$ and $F \bar{R} \bar{O} \bar{d}$ . (If $F \bar{R} \bar{O} \bar{d} = \bar{O}$ )
13	DB	DC braking command	ON: DC braking
14	PID	PID control prohibited	ON: PID control prohibited OFF: PID control permitted
15	PWENE	Permission of parameter editing	ON: Parameter editing permitted OFF: Parameter editing prohibited (If $F \bar{R} \bar{O} \bar{d} = 1$ )
16	ST+RES	Combination of standby and reset commands	ON: Simultaneous input from ST and RES
17	ST+CFMOD	Combination of standby and command/frequency setting mode switching	ON: Simultaneous input from ST and CFMOD
18	F+JOG	Combination of forward run and jog run	ON: Simultaneous input from F and JOG
19	R+JOG	Combination of reverse run and jog run	ON: Simultaneous input from R and JOG
20	F+AD2	Combination of forward run and acceleration/deceleration 2	ON: Simultaneous input from F and AD2
21	R+AD2	Combination of reverse run and acceleration/deceleration 2	ON: Simultaneous input from R and AD2
22	F+SS1	Combination of forward run and preset-speed command 1	ON: Simultaneous input from F and SS1
23	R+SS1	Combination of reverse run and preset-speed command 1	ON: Simultaneous input from R and SS1
24	F+SS2	Combination of forward run and preset-speed command 2	ON: Simultaneous input from F and SS2
25	R+SS2	Combination of reverse run and preset-speed command 2	ON: Simultaneous input from R and SS2
26	F+SS3	Combination of forward run and preset-speed command 3	ON: Simultaneous input from F and SS3
27	R+SS3	Combination of reverse run and preset-speed command 3	ON: Simultaneous input from R and SS3
28	F+SS4	Combination of forward run and preset-speed command 4	ON: Simultaneous input from F and SS4
29	R+SS4	Combination of reverse run and preset-speed command 4	ON: Simultaneous input from R and SS4
30	F+SS1+AD2	Combination of forward run, preset-speed command 1 and acceleration/deceleration 2	ON: Simultaneous input from F, SS1 and AD2
31	R+SS1+AD2	Combination of reverse run, preset-speed command 1 and acceleration/deceleration 2	ON: Simultaneous input from R, SS1 and AD2
32	F+SS2+AD2	Combination of forward run, preset-speed command 2 and acceleration/deceleration 2	ON: Simultaneous input from F, SS2 and AD2
33	R+SS2+AD2	Combination of reverse run, preset-speed command 2 and acceleration/deceleration 2	ON: Simultaneous input from R, SS2 and AD2

■ Table of input terminal functions 2

Function No.	Code	Function	Action
34	F+SS3+AD2	Combination of forward run, preset-speed command 3 and acceleration/deceleration 2	ON: Simultaneous input from F, SS3 and AD2
35	R+SS3+AD2	Combination of reverse run, preset-speed command 3 and acceleration/deceleration 2	ON: Simultaneous input from R, SS3 and AD2
36	F+SS4+AD2	Combination of forward run, preset-speed command 4 and acceleration/deceleration 2	ON: Simultaneous input from F, SS4 and AD2
37	R+SS4+AD2	Combination of reverse run, preset-speed command 4 and acceleration/deceleration 2	ON: Simultaneous input from R, SS4 and AD2
38	FCHG	Frequency command forced switching	ON: $F 2 0 7$ (if $F 2 0 0 = 0$ ) OFF: $F 1 0 d$
39	VF2	No.2 Switching of V/F setting	ON: No.2 V/F setting ( $P 1 = 0, F 1 7 0, F 1 7 1, F 1 7 2, F 1 7 3$ ) OFF: No.1 V/F setting (Set value of $P 1, u L, u L u, u b, t H r$ )
40	MOT2	No.2 motor switching (VF2+AD2+OCS2)	ON: No.2 motor ( $P 1 = 0, F 1 7 0, F 1 7 1, F 1 7 2, F 1 7 3, F 1 8 5, F 5 0 0, F 5 0 1, F 5 0 3$ ) OFF: No.1 motor (Set value of $P 1, u L, u L u, u b, t H r, R E L, d E L, F 5 0 2, F 6 0 1$ )
41	UP	Frequency UP signal input from external contacts	ON: Increase in frequency
42	DOWN	Frequency DOWN signal input from external contacts	ON: Reduction in frequency
43	CLR	Frequency UP/DOWN cancellation signal input from external contacts	OFF—ON: Resetting of UP/DOWN frequency by means of external contacts
44	CLR+RES	Combination of frequency UP/DOWN cancellation and reset by means of external contacts	ON: Simultaneous input from CLR and RES
45	EXTN	Inversion of trip stop command from external device	OFF: $\bar{E}$ Trip stop
46	OH	Thermal trip stop signal input from external device	ON: $\bar{O} H 2$ Trip stop
47	OHN	Inversion of thermal trip stop command from external device	OFF: $\bar{O} H 2$ Trip stop
48	SC/LC	Forced switching from remote to local control	Enabled when remote control is exercised ON: Local control (setting of $\bar{C} R 0 d, F 1 0 d$ and $F 2 0 7$ ) OFF: Remote control
49	HD	Operation holding (stop of 3-wire operation)	ON: F (forward run)/R: (reverse run) held, 3-wire operation OFF: Slowdown stop
50	CMP	Forced switching of command mode and terminal board command	ON: Terminal board operation OFF: Setting of $\bar{C} R 0 d$
51	CKWH	Display cancellation of the cumulative power amount (kWh)	ON: Monitor display cancellation of the cumulative power amount (kWh)
52	FORCE	Forced operation (factory configuration required)	ON: Forced operation mode in which operation is not stopped in the event of the occurrence of a soft fault (preset speed operation frequency 15) To use this function, the inverter needs to be so configured at the factory. OFF: Normal operation
53	FIRE	Fire-speed control	ON: Fire-speed operation (preset speed operation frequency 15) OFF: Normal operation

Note. When function 1, 10-12, 15-17, 38, 41-45 or 48 is assigned to an input terminal board, the input terminal board is enabled even if the parameter command mode selection  $\bar{C} R 0 d$  is set at 1 (panel).

### ■ Table of input terminal functions 3

Function No.	Code	Function	Action
54	STN	Coast stop (gate off)	ON: Coast stop (gate off)
55	RESN	Inversion of RES	ON: Acceptance of reset command OFF → ON: Trip reset
56	F+ST	Combination of forward run and standby	ON: Simultaneous input from F and ST
57	R+ST	Combination of reverse run and standby	ON: Simultaneous input from R and ST
58	AD3	Acceleration/deceleration 3 selection	ON: Acceleration/deceleration 3 OFF: Acceleration/deceleration 1 or 2
59	F+AD3	Combination of forward run and acceleration/deceleration 3	ON: Simultaneous input from F and AD3
60	R+AD3	Combination of reverse run and acceleration/deceleration 3	ON: Simultaneous input from R and AD3
61	OCS2	Forced switching of stall prevention level 2	ON: Enabled at the value of $F 105$ OFF: Enabled at the value of $F 601$
62	HDRY	Holding of RY-RC terminal output	ON: Once turned on, RY-RC are held on. OFF: The status of RY-RC changes in real time according to conditions.
63	HDOU	Holding of OUT-NO terminal output	ON: Once turned on, OUT-NO are held on. OFF: The status of OUT-NO changes in real time according to conditions.
64	PRUN	Cancellation (clearing) of operation command from panel	0: Operation command canceled (cleared) 1: Operation command retained
65	ICLR	PID control integral value clear	ON: PID control integral value always zero OFF: PID control permitted

### ■ Table of output terminal functions 1

Function No.	Code	Function	Action
0	LL	Frequency lower limit	ON: The output frequency is above the $lL$ set value. OFF: The output frequency is equal to or less than the $lL$ set value.
1	LLN	Inversion of frequency lower limit	Inversion of LL setting
2	UL	Frequency upper limit	ON: Output frequency is equal to or higher than $uL$ value. OFF: Output frequency is lower than $uL$ value.
3	ULN	Inversion of frequency upper limit	Inversion of UL setting
4	LOW	Low-speed detection signal	ON: Output frequency is equal to or higher than $F 100$ value. OFF: Output frequency is lower than $F 100$ value.
5	LOWN	Inversion of low-speed detection signal	Inversion of LOW setting
6	RCH	Designated frequency attainment signal (completion of acceleration/deceleration)	ON: The output frequency is equal to or less than the specified frequency $\pm$ frequency set with $F 102$ . OFF: The output frequency is above the specified frequency $\pm$ frequency set with $F 102$ .
7	RCHN	Inversion of designated frequency attainment signal (inversion of completion of acceleration/deceleration)	Inversion of RCH setting
8	RCHF	Set frequency attainment signal	ON: The output frequency is equal to or less than the frequency set with $F 101 \pm F 102$ . OFF: The output frequency is above the frequency set with $F 101 \pm F 102$ .
9	RCHF	Inversion of set frequency attainment signal	Inversion of RCHF setting
10	FL	Failure signal (trip output)	ON: When inverter is tripped OFF: When inverter is not tripped
11	FLN	Inversion of failure signal (inversion of trip output)	Inversion of FL setting

■ Table of output terminal functions 2

Function No.	Code	Function	Action
12	OT	Over-torque detection	ON: Torque current is equal to or larger than $F_{\beta 15}$ set value and longer than $F_{\beta 18}$ set time. OFF: The torque current is equal to or less than ( $F_{\beta 15}$ set value - $F_{\beta 19}$ set value).
13	OTN	Inversion of over-torque detection	Inversion of OT
14	RUN	Start/Stop	ON: When operation frequency is output or during (d b) OFF: Operation stopped
15	RUNN	Inversion of RUN/STOP	Inversion of RUN setting
16	POL	OL pre-alarm	ON: 50% or more of calculated value of overload protection level OFF: Less than 50% of calculated value of overload protection level
17	POLN	Inversion of OL pre-alarm	Inversion of POL setting
18	POHR	Braking resistor overload pre-alarm	ON: 50% or more of calculated value of $F_{\beta 08}$ set overload protection level OFF: Less than 50% of calculated value of $F_{\beta 08}$ set overload protection level
19	POHRN	Inversion of braking resistor overload pre-alarm	Inversion of RCHR setting
20	POT	Over-torque detection pre-alarm	ON: Torque current is equal to or larger than 70% of $F_{\beta 15}$ set value. OFF: The torque current is below ( $F_{\beta 15}$ set value x 70% - $F_{\beta 19}$ set value).
21	POTN	Inversion of over-torque detection pre-alarm	Inversion of POT setting
22	PAL	Pre-alarm	One of the following is turned on: ON POL, POHR, POT, MOFF, UC, OT, LL stop, COT, and momentary power failure slowdown stop. or $\bar{C}$ , $\bar{P}$ , $\bar{O}$ , $\bar{R}$ , $\bar{H}$ issues an alarm All the following are turned off: OFF POL, POHR, POT, MOFF, UC, OT, LL stop, COT, and momentary power failure slowdown stop. or $\bar{C}$ , $\bar{P}$ , $\bar{O}$ , $\bar{R}$ , $\bar{H}$ issues no alarm
23	PALN	Inversion of pre-alarm	Inversion of PAL setting
24	UC	Small-current detection	ON: The output current is equal to or less than $F_{\beta 11}$ set value for $F_{\beta 12}$ set time. OFF: The output current is equal to or larger than $F_{\beta 11}$ set value + 10%.
25	UCN	Inversion of small-current detection	Inversion of UC setting
26	HFL	Significant failure	ON: $\bar{O}L\bar{A}$ , $\bar{O}L\bar{L}$ , $\bar{O}E$ , $\bar{E}$ , $\bar{E}EP\bar{1}$ , $\bar{E}L\bar{n}$ , $\bar{E}PH\bar{0}$ , $\bar{E}rr\bar{2}$ - $\bar{5}$ , $\bar{O}H\bar{2}$ , $\bar{U}P\bar{1}$ , $\bar{E}F\bar{2}$ , $\bar{U}C$ , $\bar{E}L\bar{Y}P$ , $\bar{O}r$ $\bar{E}PH\bar{1}$ ) OFF: Failure other than the above
27	HFLN	Inversion of significant failure	Inversion of HFL setting
28	LFL	Insignificant failure	ON: ( $\bar{O}L\bar{1}$ - $\bar{3}$ , $\bar{O}P\bar{1}$ - $\bar{3}$ , $\bar{O}H$ , $\bar{O}L\bar{1}$ - $\bar{2}$ , $\bar{O}L\bar{r}$ ) OFF: Failure other than the above
29	LFLN	Inversion of insignificant failure	Inversion of LFL setting
30	RDY1	Ready for operation (including ST/RUN)	ON: Ready for operation (ST and RUN are also ON) OFF: Others
31	RDY1N	Inversion of ready for operation (including ST/RUN)	Inversion of RDY1 setting
32	RDY2	Ready for operation (excluding ST/RUN)	ON: Ready for operation (ST and RUN are not ON) OFF: Others
33	RDY2N	Inversion of ready for operation (excluding ST/RUN)	Inversion of RDY2
34	FCVIB	Frequency VIB selection	ON: VIB selected as frequency command OFF: Terminal other than VIB selected as frequency command

■ Table of output terminal functions 3

Function No.	Code	Function	Action
35	FCVIBN	Inversion of frequency VIB selection	Inversion of FCVIB
36	FLR	Fault signal (put out also at the time of a retry)	ON: When inverter trips or retries OFF: When inverter does not trip or retry
37	FLRN	Inversion of failure signal (put out also at the time of a retry)	Inversion of FLR
38	OUT0	Specified data output 1	ON: Specified data from remote control FA50: BIT0= 1 OFF: Specified data from remote control FA50: BIT0= 0
39	OUT0N	Inversion of specified data output 1	Inversion of OUT0 setting
40	OUT1	Specified data output 2	ON: Specified data from remote control FA50: BIT1= 1 OFF: Specified data from remote control FA50: BIT1= 0
41	OUT1N	Inversion of specified data output 2	Inversion of OUT1 setting
42	COT	Cumulative operation time alarm	ON: Cumulative operation time is equal to or longer than $F 6 2 \uparrow$ ; OFF: Cumulative operation time is shorter than $F 6 2 \uparrow$
43	COTN	Inversion of cumulative operation time alarm	Inversion of COT
44	LTA	Parts replacement alarm	ON: Calculation for parts replacement time is equal to or longer than the preset time ON: Calculation for parts replacement time is shorter than the preset time
45	LTAN	Inversion of replacement alarm	Inversion of LTA
46	BR	Braking sequence output	ON: Braking retention signal OFF: Braking release signal
47	BRN	Inversion of braking sequence output	Inversion of BR
48	LI1	F terminal input signal	ON: The signal input to F terminal is ON OFF: The signal input to F terminal is OFF
49	LI1N	Inversion of F terminal input signal	Inversion of LI1
50	LI2	R terminal input signal	ON: The signal input to R terminal is ON OFF: The signal input to R terminal is OFF
51	LI2N	Inversion of R terminal input signal	Inversion of LI2
52	PIDF	Signal in accordance of frequency command	ON: Frequency commanded by $F \uparrow \uparrow \uparrow \uparrow$ or $F 2 \uparrow \uparrow \uparrow \uparrow$ and that by VIA show the same value. OFF: Frequency commanded by $F \uparrow \uparrow \uparrow \uparrow$ or $F 2 \uparrow \uparrow \uparrow \uparrow$ and that by VIA show different values.
53	PIDFN	Inversion of signal in accordance of frequency command	Inversion of PIDF setting
54	MOFF	Undervoltage detection	ON: Undervoltage detected OFF: Other than undervoltage
55	MOFFN	Inversion of undervoltage detection	Inversion of MOFF
56-253	Disabled	Invalid settings, always OFF (ignored)	Invalid settings, always OFF (ignored)
254	AOFF	Always OFF	Always OFF
255	AON	Always ON	Always ON

■ Order of precedence of combined functions

XX: Impossible combination, X: Invalid, + : Valid under some conditions, O: Valid, @: Priority

Function No. / Function	1	2	3	4	5/ 58	6/9	10	11	50	13	14	15	46	48	41 /42	43	49	38	39	40	52	53
1 Standby		@	@	@	@	@	O	O	O	@	O	O	O	O	O	O	@	O	O	O	O	X
2 Forward run command	+		X	+	O	O	O	X	O	X	O	O	X	O	O	O	O	O	O	O	O	X
3 Reverse run command	+	@		+	O	O	O	X	O	X	O	O	X	O	O	O	O	O	O	O	O	X
4 Jug run command	+	+	+		@	+	O	X	O	X	@	O	X	O	O	O	XX	O	O	O	O	X
5/58 Acceleration/deceleration 2 or 3 selection	+	O	O	X		O	O	X	O	X	O	O	X	O	O	O	O	O	O	O	X	O
6-9 Preset-speed run commands 1 to 4	+	O	O	X	O		O	X	O	X	O	O	X	O	O	O	O	O	O	O	O	X
10 Reset command	O	O	O	O	O		O	X	O	O	O	O	X	O	O	O	O	O	O	O	O	O
11 Trip stop command from external input device	+	@	@	@	@	@	@		O	@	@	O	X	O	@	O	@	O	O	O	@	@
50 Forced switching of command mode and DC braking command	O	O	O	O	O	O	O	O	O	O	O	O	O	O	O	O	O	O	O	O	O	O
13 PID control prohibited	+	@	@	@	@	@	O	X	O		@	O	X	O	@	O	@	O	O	O	O	X
14 Permission of parameter editing	O	O	O	O	O	O	O	O	O	O	O	O	O	O	O	O	O	O	O	O	O	O
46 Thermal trip stop command from external	O	@	@	@	@	@	@	@	O	@	@	O		O	@	O	@	O	O	O	O	X
48 Remote/local control forced switching	O	O	O	O	O	O	O	O	O	O	O	O	O	O	O	O	O	O	O	O	O	O
41/42 Frequency UP/DOWN signal input from	O	O	O	O	O	O	O	X	O	X	O	O	X	O		O	O	O	O	O	O	X
43 Clearing of UP/DOWN frequency with external	O	O	O	O	O	O	O	O	O	O	O	O	O	O	O	O	O	O	O	O	O	X
49 Operation holding (cancellation of 3-wire)	+	O	O	XX	O	O	O	X	O	X	O	O	X	O	O	O		O	O	O	O	X
38 Frequency commands forced switching	O	O	O	O	O	O	O	O	O	O	O	O	O	O	O	O	O	O	O	O	O	X
39 No.2 Switching of V/F setting	O	O	O	O	O	O	O	O	O	O	O	O	O	O	O	O	O	O	O	O	X	O
40 No.2 motor switching	O	O	O	O	@	O	O	O	O	O	O	O	O	O	O	O	O	O	O	@		O
52 Forced operation	O	O	O	O	O	O	O	X	O	O	O	O	@	O	O	O	O	O	O	O	O	O
53 Fire-speed control	@	@	@	@	O	@	O	X	O	@	@	O	O	O	@	@	@	@	O	O	O	

\* For the functions of combined terminals (combined functions), refer to the table of their respective functions.

# 12. Specifications

## 12.1 Models and their standard specifications

### ■ Standard specifications

Item		Specification										
Input voltage		3-phase 240V										
Applicable motor (kW)		0.2	0.4	0.55	0.75	1.5	2.2	4.0	5.5	7.5	11	15
Rating	Type	VFS11										
	Form	2002PM	2004PM	2005PM	2007PM	2015PM	2022PM	2037PM	2055PM	2075PM	2110PM	2150PM
	Capacity (kVA) Note 1	0.6	1.3	1.4	1.8	3.0	4.2	6.7	10	13	21	25
	Rated output/current (A) Note 2	1.5	3.3	3.7	4.8	8.0	11.0	17.5	27.5	33	54	66
		(1.5)	(3.3)	(3.3)	(4.4)	(7.9)	(10.0)	(16.4)	(25.0)	(33)	(49)	(60)
Output voltage Note 3		3-phase 200V to 240V										
Overload current rating		150%-60 seconds, 200%-0.5 second										
Power supply	Voltage-frequency	3-phase 200V to 240V - 50/60Hz										
	Allowable fluctuation	Voltage + 10%, -15% Note 4), frequency ±5%										
Protective method		IP20 Enclosed type (JEM1030)										
Cooling method		Self-cooling					Forced air-cooled					
Color		Munsell 5Y-8/0.5										
Built-in filter		Basic filter										

Item		Specification													
Input voltage		1-phase 240V					3-phase 500V								
Applicable motor (kW)		0.2	0.4	0.75	1.5	2.2	0.4	0.75	1.5	2.2	4.0	5.5	7.5	11	15
Rating	Type	VFS11S					VFS11								
	Form	2002PL	2004PL	2007PL	2015PL	2022PL	4004PL	4007PL	4015PL	4022PL	4037PL	4055PL	4075PL	4110PL	4150PL
	Capacity (kVA) Note 1	0.6	1.3	1.8	3.0	4.2	1.1	1.8	3.1	4.2	7.2	11	13	21	25
	Rated output current (A) Note 2	1.5	3.3	4.8	8.0	11.0	1.5	2.3	4.1	5.5	9.5	14.3	17.0	27.7	33
		(1.5)	(3.3)	(4.4)	(7.9)	(10.0)	(1.5)	(2.1)	(3.7)	(5.0)	(8.6)	(13.0)	(17.0)	(25.0)	(30)
Rated output voltage Note 3		3-phase 200V to 240V					3-phase 380V to 500V								
Overload current rating		150%-60 seconds, 200%-0.5 second					150%-60 seconds, 200%-0.5 second								
Power supply	Voltage-current	1-phase 200V to 240V - 50/60Hz					3-phase 380V to 500V - 50/60Hz								
	Allowable fluctuation	Voltage + 10%, -15% Note 4), frequency±5%					Voltage + 10%, -15% Note 4), frequency ±5%								
Protective method.		IP20 Enclosed type (JEM1030)					IP20 Enclosed type (JEM1030)								
Cooling method		Self-cooling			Forced air-cooled		Forced air-cooled								
Color		Munsell 5Y-8/0.5													
Built-in filter		EMI filter					EMI filter								

Item		Specification									
Input voltage		3-phase 600V									
Applicable motor (kW)		0.75	1.5	2.2	4.0	5.5	7.5	11	15		
Rating	Type	VFS11-									
	Form	6007P	6015P	6022P	6037P	6055P	6075P	6110P	6150P		
	Capacity (kVA) Note 1	1.7	2.7	3.9	6.1	9	11	17	22		
	Rated output/current (A) Note 2	1.7	2.7	3.9	6.1	9.0	11.0	17.0	22.0		
		(1.5)	(2.4)	(3.5)	(5.5)	(8.1)	(9.9)	(15.3)	(19.8)		
Output voltage Note 3		3-phase 525V to 600V									
Overload current rating		150%-60 seconds, 200%-0.5 second									
Power supply	Voltage-frequency	3-phase 525V to 600V - 50/60Hz									
	Allowable fluctuation	Voltage + 10%, -15% Note 4), frequency ±5%									
Protective method		IP20 Enclosed type (JEM1030)									
Cooling method		Forced air-cooled									
Color		Munsell 5Y-8/0.5									
Built-in filter		No filter									

- Note 1. Capacity is calculated at 220V for the 240V models, at 440V for the 500V models and at 575V for the 600V models.
- Note 2. Indicates rated output current setting when the PWM carrier frequency (parameter F300) is 4kHz or less. When exceeding 4kHz, the rated output current setting is indicated in the parentheses. It needs to be further reduced for PWM carrier frequencies above 12 kHz.  
The rated output current is reduced even further for 500V models with a supply voltage of 480V or more.  
The default setting of the PWM carrier frequency is 12kHz.
- Note 3. Maximum output voltage is the same as the input voltage.
- Note 4.  $\pm 10\%$  when the inverter is used continuously (load of 100%).
- Note 5. If you are using 600V model, be sure to connect an input reactor (ACL).

## ■ Common specification

	Item	Specification
Principal control functions	Control system	Sinusoidal PWM control
	Rated output voltage	Adjustable within the range of 50 to 600V by correcting the supply voltage (not adjustable above the input voltage)
	Output frequency range	0.5 to 500.0Hz, default setting: 0.5 to 80Hz, maximum frequency: 30 to 500Hz
	Minimum setting steps of frequency	0.1Hz: analog input (when the max. frequency is 100Hz), 0.01Hz: Operation panel setting and communication setting.
	Frequency accuracy	Digital setting: within $\pm 0.01\%$ of the max. frequency (-10 to +60°C) Analog setting: within $\pm 0.5\%$ of the max. frequency (25°C $\pm 10^\circ\text{C}$ )
	Voltage/frequency characteristics	V/f constant, variable torque, automatic torque boost, vector control, automatic energy-saving, dynamic automatic energy-saving control, PM motor control. Auto-tuning. Base frequency (25 - 500Hz) adjusting to 1 or 2, torque boost (0 - 30%) adjusting to 1 or 2, adjusting frequency at start (0.5 - 10Hz)
	Frequency setting signal	Potentiometer on the front panel, external frequency potentiometer (connectable to a potentiometer with a rated impedance of 1 - 10k $\Omega$ ), 0 - 10Vdc (input impedance: VIA/VIB=30k $\Omega$ , 4 - 20mAdc (Input impedance: 250 $\Omega$ ).
	Terminal board base frequency	The characteristic can be set arbitrarily by two-point setting. Possible to set individually for three functions: analog input (VIA and VIB) and communication command.
	Frequency jump	Three frequencies can be set. Setting of the jump frequency and the range.
	Upper- and lower-limit frequencies	Upper-limit frequency: 0 to max. frequency, lower-limit frequency: 0 to upper-limit frequency
PWM carrier frequency	Adjustable within a range of 2.0 to 16.0Hz (default: 12kHz).	
PID control	Setting of proportional gain, integral gain, differential gain and control wait time. Checking whether the amount of processing amount and the amount of feedback agree.	
Operation specifications	Acceleration/deceleration time	Selectable from among acceleration/deceleration times 1, 2 and 3 (0.0 to 3200 sec.). Automatic acceleration/deceleration function. S-pattern acceleration/deceleration 1 and 2 and S-pattern adjustable. Control of forced rapid deceleration and dynamic rapid deceleration
	DC braking	Braking start-up frequency: 0 to maximum frequency, braking rate: 0 to 100%, braking time: 0 to 20 seconds, emergency DC braking, motor shaft fixing control
	Dynamic braking	Control and drive circuit is built in the inverter with the braking resistor outside (optional).
	Input terminal function (programmable)	Possible to select from among 66 functions, such as forward/reverse run signal input, jog run signal input, operation base signal input and reset signal input, to assign to 8 input terminals. Logic selectable between sink and source.
	Output terminal functions (programmable)	Possible to select from among 58 functions, such as upper/lower limit frequency signal output, low speed detection signal output, specified speed reach signal output and failure signal output, to assign to FL relay output, open collector output and RY output terminals.
	Forward/reverse run	The RUN and STOP keys on the operation panel are used to start and stop operation, respectively. The switching between forward run and reverse run can be done from one of the three control units: operation panel, terminal board and external control unit.
	Jog run	Jog mode, if selected, allows jog operation from the operation panel or the terminal board.
	Pre-set speed operation	Base frequency + 15-speed operation possible by changing the combination of 4 contacts on the terminal board.
	Retry operation	Capable of restarting automatically after a check of the main circuit elements in case the protective function is activated. 10 times (Max.) (selectable with a parameter)
	Various prohibition settings	Possible to write-protect parameters and to prohibit the change of panel frequency settings and the use of operation panel for operation, emergency stop or resetting.
	Regenerative power ride-through control	Possible to keep the motor running using its regenerative energy in case of a momentary power failure (default: OFF).
	Auto-restart operation	In the event of a momentary power failure, the inverter reads the rotational speed of the coasting motor and outputs a frequency appropriate to the rotational speed in order to restart the motor smoothly. This function can also be used when switching to commercial power.
	Drooping function	When two or more inverters are used to operate a single load, this function prevents load from concentrating on one inverter due to unbalance.
Override function	The sum of two analog signals (VIA/VIB) can be used as a frequency command value.	
Failure detection signal	1c-contact output. (250Vac-0.5A-cos $\phi$ =0.4)	

<Continued overleaf>

&lt;Continued&gt;

Item		Specification
Protective function	Protective function	Stall prevention, current limitation, over-current, output short circuit, over-voltage, over-voltage limitation, undervoltage, ground fault, power supply phase failure, output phase failure, overload protection by electronic thermal function, armature over-current at start-up, load side over-current at start-up, over-torque, undercurrent, overheating, cumulative operation time, life alarm, emergency stop, braking resistor over-current/overload, various pre-alarms
	Electronic thermal characteristic	Switching between standard motor and constant-torque VF motor, switching between motors 1 and 2, setting of overload trip time, adjustment of stall prevention levels 1 and 2, selection of overload stall
	Reset function	Function of resetting by closing contact 1a or by turning off power or the operation panel. This function is also used to save and clear trip records.
Display function	Alarms	Stall prevention, overvoltage, overload, under-voltage, setting error, retry in process, upper/lower limits
	Causes of failures	Over-current, overvoltage, overheating, short-circuit in load, ground fault, overload on inverter, over-current through arm at start-up, over-current through load at start-up, CPU fault, EEPROM fault, RAM fault, ROM fault, communication error. (Selectable: Overload of braking resistor, emergency stop, under-voltage, low voltage, over-torque, motor overload, output open-phase)
	Monitoring function	Operation frequency, operation frequency command, forward/reverse run, output current, voltage in DC section, output voltage, torque, torque current, load factor of inverter, integral load factor of PBR, input power, output power, information on input terminals, information on output terminals, version of CPU1, version of CPU2, version of memory, PID feedback amount, frequency command (after PID), integral input power, integral output power, rated current, causes of past trips 1 through 4, parts replacement alarm, cumulative operation time
	Past trip monitoring function	Stores data on the past four trips: number of trips that occurred in succession, operation frequency, direction of rotation, load current, input voltage, output voltage, information on input terminals, information on output terminals, and cumulative operation time when each trip occurred.
	Output for frequency meter	Analog output: (1mA/dc full-scale DC ammeter or 7.5V/dc full-scale DC ammeter / Rectifier-type AC voltmeter, 225% current Max. 1mA/dc, 7.5V/dc full-scale), 4 to 20mA/0 to 20mA output
	4-digit 7-segments LED	Frequency: inverter output frequency. Alarm: stall alarm "C", overvoltage alarm "P", overload alarm "L", overheat alarm "H". Status: inverter status (frequency, cause of activation of protective function, input/output voltage, output current, etc.) and parameter settings. Free-unit display: arbitrary unit (e.g. rotating speed) corresponding to output frequency.
Indicator	Lamps indicating the inverter status by lighting, such as RUN lamp, MON lamp, PRG lamp, % lamp, Hz lamp, frequency setting potentiometer lamp, UP/DOWN key lamp and RUN key lamp. The charge lamp indicates that the main circuit capacitors are electrically charged.	
Environments	Use environments	Indoor, altitude: 1000m (Max.), not exposed to direct sunlight, corrosive gas, explosive gas or vibration (less than 5.9m/s <sup>2</sup> ) (10 to 55Hz)
	Ambient temperature	-10 to +60°C Note)1,2.
	Storage temperature	-20 to +65°C
	Relative humidity	20 to 93% (free from condensation and vapor).

Note 1. Above 40°C : Remove the protective seal from the top of VF-S11.

If the ambient temperature is above 50°C: Remove the seal from the top of the inverter and use the inverter with the rated output current reduced.

Note 2. If inverters are installed side by side (with no sufficient space left between them): Remove the seal from the top of each inverter.

When installing the inverter where the ambient temperature will rise above 40°C, remove the seal from the top of the inverter and use the inverter with the rated output current reduced.

## 12.2 Outside dimensions and mass

### ■ Outside dimensions and mass

Voltage class	Applicable motor (kW)	Inverter type	Dimensions (mm)							Drawing	Approx. weight (kg)
			W	H	D	W1	H1	H2	D2		
1-phase 240V	0.2	VFS11S-2002PL	72	130	130	60	121.5	15	8	A	1.0
	0.4	VFS11S-2004PL									140
	0.75	VFS11S-2007PL			140	1.2					
	1.5	VFS11S-2015PL	105	130	150	93	13	B		1.4	
	2.2	VFS11S-2022PL	140	170	150	126	157	14		C	2.2
3-phase 240V	0.2	VFS11-2002PM	72	130	120	60	121.5	15	8	A	0.9
	0.4	VFS11-2004PM									130
	0.55	VFS11-2005PM			130	1.1					
	0.75	VFS11-2007PM			130	1.1					
	1.5	VFS11-2015PM	105	130	150	93	13	B		1.2	
	2.2	VFS11-2022PM								150	1.3
	4.0	VFS11-2037PM	140	170	150	126	157	14		C	2.2
	5.5	VFS11-2055PM	180	220	170	160	210	12		D	4.8
	7.5	VFS11-2075PM									4.9
	11	VFS11-2110PM									9.3
15	VFS11-2150PM	245	310	190	225	295	19.5	E	9.6		
3-phase 500V	0.4	VFS11-4004PL	105	130	150	93	121.5	13	8	B	1.4
	0.75	VFS11-4007PL									1.5
	1.5	VFS11-4015PL									1.5
	2.2	VFS11-4022PL									2.3
	4.0	VFS11-4037PL	140	170	150	126	157	14		C	2.5
	5.5	VFS11-4055PL	180	220	170	160	210	12		D	5.0
	7.5	VFS11-4075PL									5.1
	11	VFS11-4110PL									9.6
15	VFS11-4150PL	245	310	190	225	295	19.5	E	9.6		
3-phase 600V	0.75	VFS11-6007P	105	130	150	93	121.5	13	8	B	1.3
	1.5	VFS11-6015P									1.3
	2.2	VFS11-6022P	140	170	150	126	157	14		C	2.1
	4.0	VFS11-6037P									2.2
	5.5	VFS11-6055P									4.7
	7.5	VFS11-6075P	180	220	170	160	210	12		D	4.7
	11	VFS11-6110P	245	310	190	225	295	19.5		E	8.8
	15	VFS11-6150P									8.8

■ Outline drawing

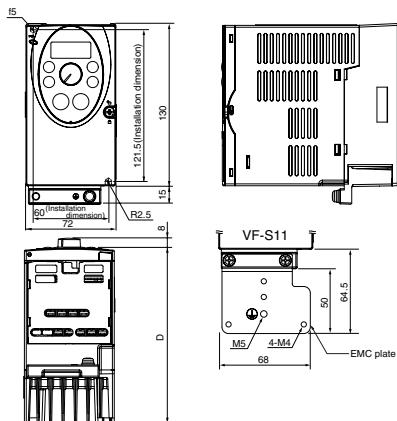

Fig.A

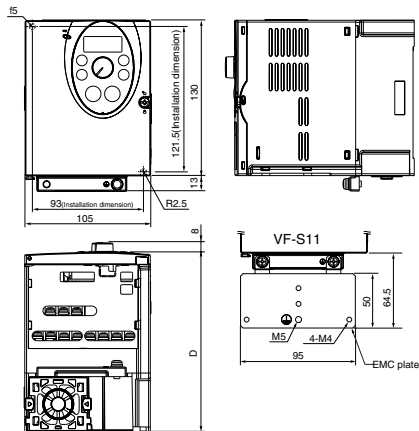

Fig.B

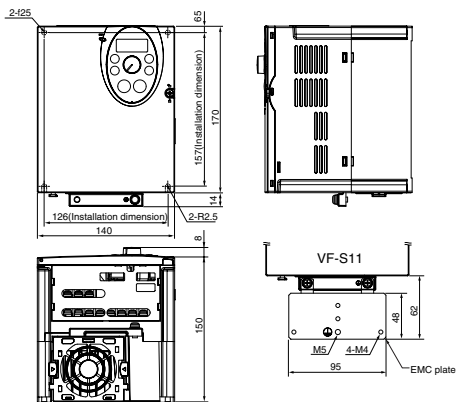

Fig.C

Note 1. To make it easier to grasp the dimensions of each inverter, dimensions common to all inverters in these figures are shown with numeric values but not with symbols.

Here are the meanings of the symbols used.

W: Width

H: Height

D: Depth

W1: Mounting dimension (horizontal)

H1: Mounting dimension (vertical)

H2: Height of EMC plate mounting area

D2: Depth of frequency setting knob

Note 2. Here are the available EMC plate

Fig.A : EMP003Z (Approx. weight : 0.1kg)

Fig.B, Fig.C : EMP004Z (Approx. weight : 0.1kg)

Fig.D : EMP005Z (Approx. weight : 0.3kg)

Fig.E : EMP006Z (Approx. weight : 0.3kg)

Note 3. The models shown in Fig. A and Fig. B are fixed at two points: in the upper left and lower right corners.

Note 4. The model shown in Fig. A is not equipped with a cooling fan.

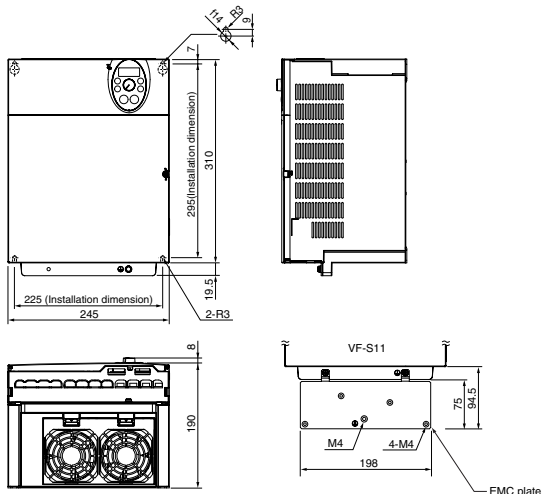
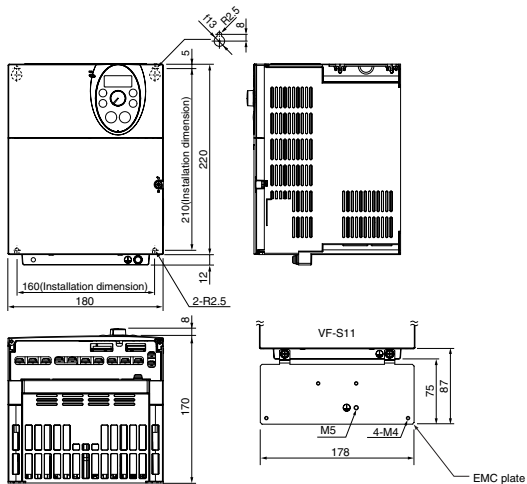

# 13. Before making a service call

## - Trip information and remedies

### 13.1 Trip causes/warnings and remedies

When a problem arises, diagnose it in accordance with the following table.

If it is found that replacement of parts is required or the problem cannot be solved by any remedy described in the table, contact your Toshiba dealer.

[Trip information]		Problem	Possible causes	Remedies
Error code	Failure code			
OC1 OC1P	0001	Overcurrent during acceleration Overcurrent flowing in element during acceleration	<ul style="list-style-type: none"> <li>The acceleration time <math>RCC</math> is too short.</li> <li>The V/F setting is improper.</li> <li>A restart signal is input to the rotating motor after a momentary stop, etc.</li> <li>A special motor (e.g. motor with a small impedance) is used.</li> </ul>	<ul style="list-style-type: none"> <li>Increase the acceleration time <math>RCC</math>.</li> <li>Check the V/F parameter.</li> <li>Use <math>F301</math> (auto-restart) and <math>F302</math> (ride-through control).</li> <li>Adjust the carrier frequency <math>F300</math>.</li> <li>Set the carrier frequency control mode selection parameter <math>F315</math> to 1 or 3 (carrier frequency decreased automatically).</li> </ul>
	0025			
OC2 OC2P	0002	Overcurrent during deceleration Overcurrent flowing in element during deceleration	<ul style="list-style-type: none"> <li>The deceleration time <math>dEC</math> is too short.</li> </ul>	<ul style="list-style-type: none"> <li>Increase the deceleration time <math>dEC</math>.</li> <li>Set the carrier frequency control mode selection parameter <math>F315</math> to 1 or 3 (carrier frequency decreased automatically).</li> </ul>
	0026			
OC3 OC3P	0003	Overcurrent during constant speed operation Overcurrent flowing in element during operation	<ul style="list-style-type: none"> <li>The load fluctuates abruptly.</li> <li>The load is in an abnormal condition.</li> </ul>	<ul style="list-style-type: none"> <li>Reduce the load fluctuation.</li> <li>Check the load (operated machine).</li> <li>Set the carrier frequency control mode selection parameter <math>F315</math> to 1 or 3 (carrier frequency decreased automatically).</li> </ul>
	0027			
OC1P OC2P OC3P	0025	Ground fault trip Arm overcurrent at start-up (for 11 and 15 kW models only)	<ul style="list-style-type: none"> <li>A current leaked from an output cable or the motor to ground.</li> <li>A main circuit elements is defective.</li> </ul>	<ul style="list-style-type: none"> <li>Check cables, connectors, and so on for ground faults.</li> <li>Make a service call.</li> </ul>
	0026			
	0027			
OC4	0004	Overcurrent (An overcurrent on the load side at start-up)	<ul style="list-style-type: none"> <li>The insulation of the output main circuit or motor is defective.</li> <li>The motor has too small impedance.</li> <li>A 11 or 15 kW model was started, although a current is leaked from an output cable or the motor to ground.</li> </ul>	<ul style="list-style-type: none"> <li>Check the cables and wires for defective insulation.</li> <li>When using a 11 or 15 kW model, check cables, connectors, and so on for ground faults.</li> </ul>
OCRA	0005	Arm overcurrent at start-up	<ul style="list-style-type: none"> <li>A main circuit elements is defective.</li> </ul>	<ul style="list-style-type: none"> <li>Make a service call.</li> </ul>
* EPH1	0008	Input phase failure	<ul style="list-style-type: none"> <li>A phase failure occurred in the input line of the main circuit.</li> <li>The capacitor in the main circuit lacks capacitance.</li> </ul>	<ul style="list-style-type: none"> <li>Check the main circuit input line for phase failure.</li> <li>Enable <math>F508</math> (input phase failure detection).</li> <li>Check the capacitor in the main circuit for exhaustion.</li> </ul>
* EPH0	0009	Output phase failure	<ul style="list-style-type: none"> <li>A phase failure occurred in the output line of the main circuit.</li> </ul>	<ul style="list-style-type: none"> <li>Check the main circuit output line, motor, etc. for phase failure.</li> <li>Enable <math>F505</math> (Output phase failure detection).</li> </ul>

\* You can select a trip ON/OFF by parameters.  
(Continued overleaf)

(Continued)

Error code	Failure code	Problem	Possible causes	Remedies
<i>OP1</i>	000A	Overvoltage during acceleration	<ul style="list-style-type: none"> <li>The input voltage fluctuates abnormally.</li> <li>(1) The power supply has a capacity of 200kVA or more.</li> <li>(2) A power factor improvement capacitor is opened or closed.</li> <li>(3) A system using a thyrister is connected to the same power distribution line.</li> <li>A restart signal is input to the rotating motor after a momentary stop, etc.</li> </ul>	<ul style="list-style-type: none"> <li>Insert a suitable input reactor.</li> <li>Use <i>F301</i> (auto-restart) and <i>F302</i> (ride-through control).</li> </ul>
<i>OP2</i>	000B	Overvoltage during deceleration	<ul style="list-style-type: none"> <li>The deceleration time <i>dEC</i> is too short. (Regenerative energy is too large.)</li> <li><i>F304</i> (dynamic braking resistor) is off.</li> <li><i>F305</i> (overvoltage limit operation) is off.</li> <li>The input voltage fluctuates abnormally.</li> <li>(1) The power supply has a capacity of 200kVA or more.</li> <li>(2) A power factor improvement capacitor is opened and closed.</li> <li>(3) A system using a thyrister is connected to the same power distribution line.</li> </ul>	<ul style="list-style-type: none"> <li>Increase the deceleration time <i>dEC</i>.</li> <li>Install a dynamic braking resistor.</li> <li>Enable <i>F304</i> (dynamic braking resistor).</li> <li>Enable <i>F305</i> (overvoltage limit operation).</li> <li>Insert a suitable input reactor.</li> </ul>
<i>OP3</i>	000C	Overvoltage during constant-speed operation	<ul style="list-style-type: none"> <li>The input voltage fluctuates abnormally.</li> <li>(1) The power supply has a capacity of 200kVA or more.</li> <li>(2) A power factor improvement capacitor is opened or closed.</li> <li>(3) A system using a thyrister is connected to the same power distribution line.</li> <li>The motor is in a regenerative state because the load causes the motor to run at a frequency higher than the inverter output frequency.</li> </ul>	<ul style="list-style-type: none"> <li>Insert a suitable input reactor.</li> <li>Install a dynamic braking resistor.</li> </ul>
<i>OL1</i>	000D	Inverter overload	<ul style="list-style-type: none"> <li>The acceleration time ACC is too short.</li> <li>The DC braking amount is too large.</li> <li>The V/F setting is improper.</li> <li>A restart signal is input to the rotating motor after a momentary stop, etc.</li> <li>The load is too large.</li> </ul>	<ul style="list-style-type: none"> <li>Increase the acceleration time <i>ACC</i>.</li> <li>Reduce the DC braking amount <i>F251</i> and the DC braking time <i>F252</i>.</li> <li>Check the V/F parameter setting.</li> <li>Use <i>F301</i> (auto-restart) and <i>F302</i> (ride-through control).</li> <li>Use an inverter with a larger rating.</li> </ul>
<i>OL2</i>	000E	Motor overload	<ul style="list-style-type: none"> <li>The V/F setting is improper.</li> <li>The motor is locked up.</li> <li>Low-speed operation is performed continuously.</li> <li>An excessive load is applied to the motor during operation.</li> </ul>	<ul style="list-style-type: none"> <li>Check the V/F parameter setting.</li> <li>Check the load (operated machine).</li> <li>Adjust <i>OLN</i> to the overload that the motor can withstand during operation in a low speed range.</li> </ul>
<i>OLr</i>	000F	Dynamic braking resistor overload trip	<ul style="list-style-type: none"> <li>The deceleration time is too short.</li> <li>Dynamic braking is too large.</li> </ul>	<ul style="list-style-type: none"> <li>Increase the deceleration time <i>dEC</i>.</li> <li>Increase the capacity of dynamic braking resistor (wattage) and adjust PBR capacity parameter <i>F300</i>.</li> </ul>
* <i>Ob</i>	0020	Over-torque trip	<ul style="list-style-type: none"> <li>Over-torque reaches to a detection level during operation.</li> </ul>	<ul style="list-style-type: none"> <li>Enable <i>F515</i> (over-torque trip selection).</li> <li>Check system error.</li> </ul>
<i>OH</i>	0010	Overheat	<ul style="list-style-type: none"> <li>The cooling fan does not rotate.</li> <li>The ambient temperature is too high.</li> <li>The vent is blocked up.</li> <li>A heat generating device is installed close to the inverter.</li> <li>The thermistor in the unit is broken.</li> </ul>	<ul style="list-style-type: none"> <li>Restart the operation by resetting the inverter after it has cooled down enough.</li> <li>The fan requires replacement if it does not rotate during operation.</li> <li>Secure sufficient space around the inverter.</li> <li>Do not place any heat generating device near the inverter.</li> <li>Make a service call.</li> </ul>

\* You can select a trip ON/OFF by parameters.  
(Continued overleaf)

(Continued)

Error code	Failure code	Problem	Possible causes	Remedies
<i>OH2</i> <i>E</i>	002E	External thermal trip	<ul style="list-style-type: none"> <li>An external thermal trip is input.</li> </ul>	<ul style="list-style-type: none"> <li>Check the external thermal input.</li> </ul>
	0011	Emergency stop	<ul style="list-style-type: none"> <li>During automatic operation or remote operation, a stop command is entered from the operation panel or a remote input device.</li> </ul>	<ul style="list-style-type: none"> <li>Reset the inverter.</li> </ul>
<i>EEP1</i>	0012	EEPROM fault 1	<ul style="list-style-type: none"> <li>A data writing error occurs.</li> </ul>	<ul style="list-style-type: none"> <li>Turn off the inverter, then turn it again. If it does not recover from the error, make a service call.</li> </ul>
<i>EEP2</i>	0013	EEPROM fault 2	<ul style="list-style-type: none"> <li>Power supply is cut off during <i>LYP</i> operation and data writing is aborted.</li> </ul>	<ul style="list-style-type: none"> <li>Turn the power off temporarily and turn it back on, and then try <i>LYP</i> operation again.</li> </ul>
<i>EEP3</i>	0014	EEPROM fault 3	<ul style="list-style-type: none"> <li>A data reading error occurred.</li> </ul>	<ul style="list-style-type: none"> <li>Turn off the inverter, then turn it again. If it does not recover from the error, make a service call.</li> </ul>
<i>Err2</i>	0015	Main unit RAM fault	<ul style="list-style-type: none"> <li>The control RAM is defective.</li> </ul>	<ul style="list-style-type: none"> <li>Make a service call.</li> </ul>
<i>Err3</i>	0016	Main unit ROM fault	<ul style="list-style-type: none"> <li>The control ROM is defective.</li> </ul>	<ul style="list-style-type: none"> <li>Make a service call.</li> </ul>
<i>Err4</i>	0017	CPU fault 1	<ul style="list-style-type: none"> <li>The control CPU is defective.</li> </ul>	<ul style="list-style-type: none"> <li>Make a service call.</li> </ul>
<i>Err5</i>	0018	Remote control error	<ul style="list-style-type: none"> <li>An error arises during remote operation.</li> </ul>	<ul style="list-style-type: none"> <li>Check the remote control device, cables, etc.</li> </ul>
<i>Err7</i>	001A	Current detector fault	<ul style="list-style-type: none"> <li>The current detector is defective.</li> </ul>	<ul style="list-style-type: none"> <li>Make a service call.</li> </ul>
<i>Err8</i>	001B	Optional circuit board format error	<ul style="list-style-type: none"> <li>An optional circuit board in a different format is installed.</li> </ul>	<ul style="list-style-type: none"> <li>Check again to be sure that the circuit board is connected correctly, and then reset the power supply.</li> <li>Replace the circuit board with a correctly formatted one.</li> </ul>
* <i>UC</i>	001D	Low-current operation Trip	<ul style="list-style-type: none"> <li>The output current decreased to a low-current detection level during operation.</li> </ul>	<ul style="list-style-type: none"> <li>Enable <i>F610</i> (low-current detection).</li> <li>Check the suitable detection level for the system (<i>F611</i>, <i>F612</i>).</li> <li>Make a service call if the setting is correct.</li> </ul>
* <i>UP1</i>	001E	Undervoltage trip (main circuit)	<ul style="list-style-type: none"> <li>The input voltage (in the main circuit) is too low.</li> </ul>	<ul style="list-style-type: none"> <li>Check the input voltage.</li> <li>Enable <i>F627</i> (undervoltage trip selection).</li> <li>To cope with a momentary stop due to undervoltage, enable <i>F300</i> (ride-through control) and <i>F301</i> (auto-restart).</li> </ul>
<i>EF2</i>	0022	Ground fault trip	<ul style="list-style-type: none"> <li>A ground fault occurs in the output cable or the motor.</li> </ul>	<ul style="list-style-type: none"> <li>Check the cable and the motor for ground faults.</li> </ul>
<i>En1</i>	0054	Auto-tuning error	<ul style="list-style-type: none"> <li>Check the motor parameter <i>F401</i> to <i>F494</i>.</li> <li>The motor with the capacity of 2 classes or less than the inverter is used.</li> <li>The output cable is too thin.</li> <li>The motor is rotating.</li> <li>The inverter is used for loads other than those of three-phase induction motors.</li> </ul>	
<i>ELYP</i>	0029	Inverter type error	<ul style="list-style-type: none"> <li>Circuit board is changed. (Or main circuit/drive circuit board)</li> </ul>	<ul style="list-style-type: none"> <li>Make a service call.</li> </ul>
* <i>E-18</i>	0032	Brea In analog signal cable	<ul style="list-style-type: none"> <li>The signal input via VIA is below the analog signal detection level set with <i>F633</i>.</li> </ul>	<ul style="list-style-type: none"> <li>Check the cables for breaks. And check the setting of input signal or setting value of <i>F633</i>.</li> </ul>
<i>E-19</i>	0033	CPU communications error	<ul style="list-style-type: none"> <li>A communications error occurs between control CPUs.</li> </ul>	<ul style="list-style-type: none"> <li>Make a service call.</li> </ul>
<i>E-20</i>	0034	Excessive torque boosted	<ul style="list-style-type: none"> <li>The torque boost parameter <i>F402</i> is set too high.</li> <li>The motor has too small impedance.</li> </ul>	<ul style="list-style-type: none"> <li>Decrease the setting of the torque boost parameter <i>F402</i>.</li> </ul>
<i>E-21</i>	0035	CPU fault 2	<ul style="list-style-type: none"> <li>The control CPU is defective.</li> </ul>	<ul style="list-style-type: none"> <li>Make a service call.</li> </ul>
<i>SOUE</i>	002F	Step-out (For PM motor only)	<ul style="list-style-type: none"> <li>The motor shaft is locked.</li> <li>One output phase is open.</li> <li>An impact load is applied.</li> </ul>	<ul style="list-style-type: none"> <li>Unlock the motor shaft.</li> <li>Check the interconnect cables between the inverter and the motor.</li> </ul>

\* You can select a trip ON/OFF by parameters.

[Alarm information] Each message in the table is displayed to give a warning but does not cause the inverter to trip.

Error code	Problem	Possible causes	Remedies
<i>OFF</i>	ST terminal OFF	<ul style="list-style-type: none"> <li>The ST-CC circuit is opened.</li> </ul>	<ul style="list-style-type: none"> <li>Close the ST-CC circuit.</li> </ul>
<i>UVFF</i>	Undervoltage in main circuit	<ul style="list-style-type: none"> <li>The supply voltage between R, S and T is under voltage.</li> </ul>	<ul style="list-style-type: none"> <li>Measure the main circuit supply voltage. If the voltage is at a normal level, the inverter requires repairing.</li> </ul>
<i>rtRY</i>	Retry in process	<ul style="list-style-type: none"> <li>The inverter is in the process of retry.</li> <li>A momentary stop occurred.</li> </ul>	<ul style="list-style-type: none"> <li>The inverter is normal if it restarts after several tens of seconds. The inverter restarts automatically. Be careful of the machine because it may suddenly restart.</li> </ul>
<i>Err 1</i>	Frequency point setting error alarm	<ul style="list-style-type: none"> <li>The frequency setting signals at points 1 and 2 are set too close to each other.</li> </ul>	<ul style="list-style-type: none"> <li>Set the frequency setting signals at points 1 and 2 apart from each other.</li> </ul>
<i>CLR</i>	Clear command acceptable	<ul style="list-style-type: none"> <li>This message is displayed when pressing the STOP key while an error code is displayed.</li> </ul>	<ul style="list-style-type: none"> <li>Press the STOP key again to clear the trip.</li> </ul>
<i>EOFF</i>	Emergency stop command acceptable	<ul style="list-style-type: none"> <li>The operation panel is used to stop the operation in automatic control or remote control mode.</li> </ul>	<ul style="list-style-type: none"> <li>Press the STOP key for an emergency stop. To cancel the emergency stop, press any other key.</li> </ul>
<i>H/L</i>	Setting error alarm / An error code and data are displayed alternately twice each.	<ul style="list-style-type: none"> <li>An error is found in a setting when data is reading or writing.</li> </ul>	<ul style="list-style-type: none"> <li>Check whether the setting is made correctly.</li> </ul>
<i>HEAd/End</i>	Display of first/last data items	<ul style="list-style-type: none"> <li>The first and last data item in the <i>RUH</i> data group is displayed.</li> </ul>	<ul style="list-style-type: none"> <li>Press MODE key to exit the data group.</li> </ul>
<i>db</i>	DC braking	<ul style="list-style-type: none"> <li>DC braking in process</li> </ul>	<ul style="list-style-type: none"> <li>The message goes off in several tens of seconds if no problem occurs. Note</li> </ul>
<i>dbon</i>	Shaft fixing control	<ul style="list-style-type: none"> <li>Motor shaft fixing control is in process.</li> </ul>	<ul style="list-style-type: none"> <li>Normal if the message disappears when a stop command is entered (or the operation command is canceled).</li> </ul>
<i>F1</i> <i>F2</i> <i>F3</i>	Flowing out of excess number of digits	<ul style="list-style-type: none"> <li>The number of digits such as frequencies is more than 4. (The upper digits have a priority.)</li> </ul>	<ul style="list-style-type: none"> <li>Lower the frequency free unit magnification <i>F 7 0 2</i>.</li> </ul>
<i>SEOP</i>	Momentary power failure slowdown stop prohibition function activated.	<ul style="list-style-type: none"> <li>The slowdown stop prohibition function set with <i>F 3 0 2</i> (momentary power failure ride-through operation) is activated.</li> </ul>	<ul style="list-style-type: none"> <li>To restart operation, reset the inverter or input an operation signal again.</li> </ul>
<i>LESP</i>	Auto-stop because of continuous operation at the lower-limit frequency	<ul style="list-style-type: none"> <li>The automatic stop function selected with <i>F 2 5 5</i> was activated.</li> </ul>	<ul style="list-style-type: none"> <li>To deactivate the automatic stop function, increase the frequency command above the lower-limit frequency (LL) + 0.2 Hz or turn off the operation command.</li> </ul>
<i>inIt</i>	Parameters in the process of initialization	<ul style="list-style-type: none"> <li>Parameters are being initialized to default values.</li> </ul>	<ul style="list-style-type: none"> <li>Normal if the message disappears after a while (several seconds to several tens of seconds).</li> </ul>
<i>E-17</i>	Operation panel key fault	<ul style="list-style-type: none"> <li>The RUN or STOP key is held down for more than 20 seconds.</li> <li>The RUN or STOP key is faulty.</li> </ul>	<ul style="list-style-type: none"> <li>Check the operation panel.</li> </ul>
<i>Autn i</i>	Auto-tuning	<ul style="list-style-type: none"> <li>Auto-tuning in process</li> </ul>	<ul style="list-style-type: none"> <li>Normal if the message disappears after a few seconds.</li> </ul>

Note) When the ON/OFF function is selected for DC braking (DB), using the input terminal selection parameter, you can judge the inverter to be normal if "db" disappears when opening the circuit between the terminal and CC.

[Prealarm display]

<i>C</i>	Overcurrent alarm	Same as <i>OC</i> (overcurrent)
<i>P</i>	Overvoltage alarm	Same as <i>OP</i> (overvoltage)
<i>L</i>	Overload alarm	Same as <i>OL 1</i> and <i>OL 2</i> (overload)
<i>H</i>	Overheat alarm	Same as <i>OH</i> (overheat)

If two or more problems arise simultaneously, one of the following alarms appears and blinks.

$\overline{CP}$ ,  $P_L$ ,  $\overline{CP_L}$

The blinking alarms  $\overline{C}$ ,  $P$ ,  $L$ ,  $H$  are displayed in this order from left to right.

## 13.2 Restoring the inverter from a trip

Do not reset the inverter when tripped because of a failure or error before eliminating the cause. Resetting the tripped inverter before eliminating the problem causes it to trip again.

The inverter can be restored from a trip by any of the following operations:

- (1) By turning off the power (Keep the inverter off until the LED turns off.)  
Note) Refer to 6.15.3 (inverter trip retention selection  $F5 \overline{Q} \overline{Q}^2$ ) for details.
- (2) By means of an external signal (Short circuit between RES and CC on terminal board → Open)
- (3) By operation panel operation
- (4) By inputting a trip clear signal from a remote input device  
(Refer to the remote input device operating manual for details.)

To reset the inverter by operation panel operation, follow these steps.

1. Press the STOP key and make sure that  $\overline{C} \overline{L} r$  is displayed.
2. Pressing the STOP key again will reset the inverter if the cause of the trip has already been eliminated.

- ★ When any overload function [ $\overline{Q} \overline{L} 1$ : inverter overload,  $\overline{Q} \overline{L} 2$ : motor overload,  $\overline{Q} \overline{L} r$ : braking resistor overload] is active, the inverter cannot be reset by inputting a reset signal from an external device or by operation panel operation before the virtual cooling time has passed.

Virtual cooling time ...  $\overline{Q} \overline{L} 1$ : about 30 seconds after the occurrence of a trip

$\overline{Q} \overline{L} 2$ : about 120 seconds after a occurrence of a trip

$\overline{Q} \overline{L} r$ : about 20 seconds after a occurrence of a trip

- ★ In case of a trip due to overheating ( $\overline{Q} H$ ), the inverter checks the temperature within. Wait until the temperature in the inverter falls sufficiently before resetting the inverter.

### [Caution]

Turning the inverter off then turning it on again resets the inverter immediately. You can use this mode of resetting if there is a need to reset the inverter immediately. Note, however, that this operation may damage the system or the motor if it is repeated frequently.

## 13.3 If the motor does not run while no trip message is displayed ...

If the motor does not run while no trip message is displayed, follow these steps to track down the cause.

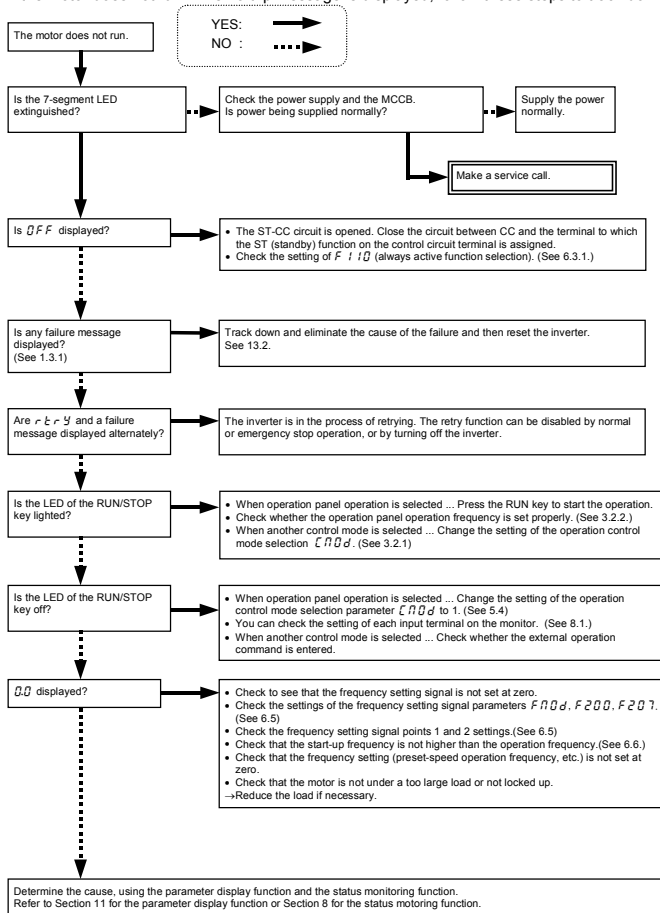

## 13.4 How to determine the causes of other problems



The following table provides a listing of other problems, their possible causes and remedies.

Problems	Causes and remedies
The motor runs in the wrong direction.	<ul style="list-style-type: none"> <li>• Invert the phases of the output terminals U, V and W.</li> <li>• Invert the forward/reverse run-signal terminals of the external input device. (See 6.3 "Assignment of functions to control terminals".)</li> <li>• Change the setting of the parameter <math>F_r</math> in the case of panel operation.</li> </ul>
The motor runs but its speed does not change normally.	<ul style="list-style-type: none"> <li>• The load is too heavy. Reduce the load.</li> <li>• The soft stall function is activated. Disable the soft stall function. (See 5.14.)</li> <li>• The maximum frequency <math>F_H</math> and the upper limit frequency <math>U_L</math> are set too low. Increase the maximum frequency <math>F_H</math> and the upper limit frequency <math>U_L</math>.</li> <li>• The frequency setting signal is too low. Check the signal set value, circuit, cables, etc.</li> <li>• Check the setting characteristics (point 1 and point 2 settings) of the frequency setting signal parameters. (See 6.5.)</li> <li>• If the motor runs at a low speed, check to see that the stall prevention function is activated because the torque boost amount is too large. Adjust the torque boost amount (<math>\nu_b</math>) and the acceleration time (<math>R_L</math>). (See 5.12 and 5.1.)</li> </ul>
The motor does not accelerate or decelerate smoothly.	<ul style="list-style-type: none"> <li>• The acceleration time (<math>R_L</math>) or the deceleration time (<math>dE_L</math>) is set too short. Increase the acceleration time (<math>R_L</math>) or the deceleration time (<math>dE_L</math>).</li> </ul>
A too large current flows into the motor.	<ul style="list-style-type: none"> <li>• The load is too heavy. Reduce the load.</li> <li>• If the motor runs at a low speed, check whether the torque boost amount is too large. (See 5.12.)</li> </ul>
The motor runs at a higher or lower speed than the specified one.	<ul style="list-style-type: none"> <li>• The motor has an improper voltage rating. Use a motor with a proper voltage rating.</li> <li>• The motor terminal voltage is too low. Check the setting of the base frequency voltage parameter (<math>\omega_L</math>). (See 6.13.6.) Replace the cable with a cable larger in diameter.</li> <li>• The reduction gear ratio, etc., are not set properly. Adjust the reduction gear ratio, etc.</li> <li>• The output frequency is not set correctly. Check the output frequency range.</li> <li>• Adjust the base frequency. (See 5.10.)</li> </ul>
The motor speed fluctuates during operation.	<ul style="list-style-type: none"> <li>• The load is too heavy or too light. Reduce the load fluctuation.</li> <li>• The inverter or motor used does not have a rating large enough to drive the load. Use an inverter or motor with a rating large enough.</li> <li>• Check whether the frequency setting signal changes.</li> <li>• If the V/F control selection parameter <math>P_L</math> is set at 3, check the vector control setting, operation conditions, etc. (See 5.11.)</li> </ul>
Parameter settings cannot be changed.	<p>Change the setting of the parameter <math>F_{\text{lock}}</math> (prohibition of change of parameter setting) to 0 (permitted) if it is set at 1 (prohibited).</p> <p>* For reasons of safety, some parameters cannot be reprogrammed while the inverter is running. (see 4.1.5)</p>

### How to cope with parameter setting-related problems

If you forget parameters which have been reset	<ul style="list-style-type: none"> <li>• You can search for all reset parameters and change their settings.</li> <li>* Refer to 4.1.3 for details.</li> </ul>
If you want to return all reset parameters to their respective default settings	<ul style="list-style-type: none"> <li>• You can return all parameters which have been reset to their default settings.</li> <li>* Refer to 4.1.6 for details.</li> </ul>

## 14. Inspection and maintenance

 Danger	
 Mandatory	<ul style="list-style-type: none"> <li>• The equipment must be inspected every day. If the equipment is not inspected and maintained, errors and malfunctions may not be discovered which could lead to accidents.</li> <li>• Before inspection, perform the following steps.               <ol style="list-style-type: none"> <li>(1) Shut off all input power to the inverter.</li> <li>(2) Wait at least ten minutes and check to make sure that the charge lamp is no longer lit.</li> <li>(3) Use a tester that can measure DC voltages (800V DC or more), and check that the voltage to the DC main circuits (across PA-PC) does not exceed 45V.</li> </ol> </li> </ul> <p style="text-align: center;"><b>Performing an inspection without carrying out these steps first could lead to electric shock.</b></p>

Be sure to inspect the inverter regularly and periodically to prevent it from breaking down because of the environment of use, such as temperature, humidity, dust and vibration, or deterioration of its components with aging.

### 14.1 Regular inspection

Since electronic parts are susceptible to heat, install the inverter in a cool, well-ventilated and dust-free place. This is essential for increasing the service life.

The purpose of regular inspections is to maintain the correct environment of use and to find any sign of failure or malfunction by comparing current operation data with past operation records.

Subject of inspection	Inspection procedure			Criteria for judgement
	Inspection item	Inspection cycle	Inspection method	
1. Indoor environment	1) Dust, temperature and gas	Occasionally	1) Visual check, check by means of a thermometer, smell check	1) Improve the environment if it is found to be unfavorable.
	2) Drop of water or other liquid	Occasionally	2) Visual check	2) Check for any trace of water condensation.
	3) Room temperature	Occasionally	3) Check by means of a thermometer	3) Max. temperature: 60°C
2. Units and components	1) Vibration and noise	Occasionally	Tactile check of the cabinet	Is something unusual is found, open the door and check the transformer, reactors, contactors, relays, cooling fan, etc., inside. If necessary, stop the operation.
3. Operation data (output side)	1) Load current	Occasionally	Moving-iron type AC ammeter	To be within the rated current, voltage and temperature. No significant difference from data collected in a normal state.
	2) Voltage (*)	Occasionally	Rectifier type AC voltmeter	
	3) Temperature	Occasionally	Thermometer	



\*) The voltage measured may slightly vary from voltmeter to voltmeter. When measuring the voltage, always take readings from the same circuit tester or voltmeter.

## ■ Check points

1. Something unusual in the installation environment
2. Something unusual in the cooling system
3. Unusual vibration or noise
4. Overheating or discoloration
5. Unusual odor
6. Unusual motor vibration, noise or overheating
7. Adhesion or accumulation of foreign substances (conductive substances)

## 14.2 Periodical inspection

Make a periodical inspection at intervals of 3 or 6 months depending on the operating conditions.

 <b>Danger</b>	
 Mandatory	<ul style="list-style-type: none"> <li>• Before inspection, perform the following steps.               <ol style="list-style-type: none"> <li>(1) Shut off all input power to the inverter.</li> <li>(2) Wait at least ten minutes and check to make sure that the charge lamp is no longer lit.</li> <li>(3) Use a tester that can measure DC voltages (800V DC or more), and check that the voltage to the DC main circuits (across PA-PC) does not exceed 45V.</li> </ol> </li> <li>Performing an inspection without carrying out these steps first could lead to electric shock.</li> </ul>
 Prohibited	<ul style="list-style-type: none"> <li>• Never replace any part. This could be a cause of electric shock, fire and bodily injury. To replace parts, call the local sales agency.</li> </ul>

## ■ Check items

1. Check to see if all screwed terminals are tightened firmly. If any screw is found loose, tighten it again with a screwdriver.
2. Check to see if all caulked terminals are fixed properly. Check them visually to see that there is no trace of overheating around any of them.
3. Check all cables and wires for damage. Check them visually.
4. Remove dirt and dust. With a vacuum cleaner, remove dirt and dust. When cleaning, clean the vents and the printed circuit boards. Always keep them clean to prevent an accident due to dirt or dust.
5. If no power is supplied to the inverter for a long time, the performance of its large-capacity electrolytic capacitor declines.  
When leaving the inverter unused for a long time, supply it with electricity once every two years, for 5 hours or more each, to recover the performance of the large-capacity electrolytic capacitor. And also check the function of the inverter. It is advisable not to supply the commercial power directly to the inverter but to gradually increase the power supply voltage with a transformer, etc.
6. If the need arises, conduct an insulation test on the main circuit terminal board only, using a 500V insulation tester. Never conduct an insulation test on control terminals other than terminals on the printed circuit board or on control terminals. When testing the motor for insulation performance, separate it from the inverter in advance by disconnecting the cables from the inverter output terminals U, V and W. When conducting an insulation test on peripheral circuits other than the motor circuit, disconnect all cables from the inverter so that no voltage is applied to the inverter during the test.

(Note) Before an insulation test, always disconnect all cables from the main circuit terminal board and test the inverter separately from other equipment..

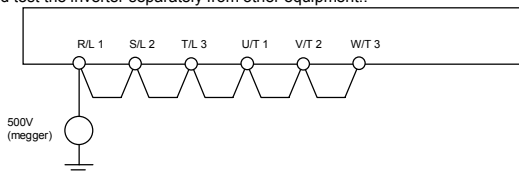

7. Never test the inverter for pressure. A pressure test may cause damage to its components.
8. Voltage and temperature check

Recommended voltmeter : Input side ... Moving-iron type voltmeter (↺)

Output side ... Rectifier type voltmeter (▶)

It will be very helpful for detecting a defect if you always measure and record the ambient temperature before, during and after the operation.

## ■ Replacement of expendable parts

The inverter is composed of a large number of electronic parts including semiconductor devices. The following parts deteriorate with the passage of time because of their composition or physical properties. The use of aged or deteriorated parts leads to degradation in the performance or a breakdown of the inverter. To avoid such trouble, the inverter should be checked periodically.

(Note) Generally, the life of a part depends on the ambient temperature and the conditions of use. The life spans listed below are applicable to parts when used under normal environmental conditions.

### 1) Cooling fan

The fan, which cools down heat-generating parts, has a service life of about 30,000 hours (about 2 or 3 years of continuous operation). The fan also needs to be replaced if it makes a noise or vibrates abnormally.

### 2) Smoothing capacitor

The smoothing aluminum electrolytic capacitor in the main circuit DC section degrades in performance because of ripple currents, etc. It becomes necessary to replace the capacitor after it is used for about 5 years under normal conditions. Since the smoothing capacitor is mounted on a printed circuit board, it needs to be replaced together with the circuit board.

<Criteria for appearance check>

- Absence of liquid leak
- Safety valve in the depressed position
- Measurement of electrostatic capacitance and insulation resistance

Note: The operation time is helpful for roughly determining the time of replacement. For the replacement of parts, contact your nearest Toshiba inverter distributor. For safety's sake, never replace any part on your own. (Parts replacement alarms can be known by monitor and alarm output, if it is set. Refer to section 6.19.14)

## ■ Standard replacement cycles of principal parts

As guides, the table below lists part replacement cycles that were estimated based on the assumption that the inverter would be used in a normal use environment under normal conditions (ambient temperature, ventilation conditions, and energizing time). The replacement cycle of each part does not mean its service life but the number of years over which its failure rate does not increase significantly.

Part name	Standard replacement cycle	Replacement mode and others
Cooling fan	2 to 3 years	Replacement with a new one
Main circuit smoothing aluminum electrolytic capacitor	5 years	Replacement with a new one
Relay and contactor	-	Whether to replace or not depends on the check results
Aluminum electrolytic capacitor mounted on a printed circuit board	5 years	Replace with a new circuit board

Note) The life of a part greatly varies depending on the environment of use.

## 14.3 Making a call for servicing

For the Toshiba service network, refer to the back cover of this instruction manual. If defective conditions are encountered, please contact the Toshiba service section in charge via your Toshiba dealer.

When making a call for servicing, please inform us of the contents of the rating label on the right panel of the inverter, the presence or absence of optional devices, etc., in addition to the details of the failure.

## 14.4 Keeping the inverter in storage

Take the following precautions when keeping the inverter in storage temporarily or for a long period of time.

1. Store the inverter in a well-ventilated place away from heat, damp, dust and metal powder.
2. If the printed circuit board in your inverter has an anti-static cover (black cover), do not leave it detached from the circuit board during storage. The cover must be detached before turning on the inverter.
3. If no power is supplied to the inverter for a long time, the performance of its large-capacity electrolytic capacitor declines.

When leaving the inverter unused for a long time, supply it with electricity once every two years, for 5 hours or more each, to recover the performance of the large-capacity electrolytic capacitor. And also check the function of the inverter. It is advisable not to supply the commercial power directly to the inverter but to gradually increase the power supply voltage with a transformer, etc.

## 15. Warranty



Any part of the inverter that proves defective will be repaired and adjusted free of charge under the following conditions:

1. This warranty applies only to the inverter main unit.
2. Any part of the inverter which fails or is damaged under normal use within twelve months from the date of delivery shall be repaired free of charge.
3. For the following kinds of failure or damage, the repair cost shall be borne by the customer even within the warranty period.
  - Failure or damage caused by improper or incorrect use or handling, or unauthorized repair or modification of the inverter
  - Failure or damage caused by the inverter falling or an accident during transportation after the purchase
  - Failure or damage caused by fire, salty water or wind, corrosive gas, earthquake, storm or flood, lightning, abnormal voltage supply, or other natural disasters
  - Failure or damage caused by the use of the inverter for any purpose or application other than the intended one
4. All expenses incurred by Toshiba for on-site services shall be charged to the customer, unless a service contract is signed beforehand between the customer and Toshiba, in which case the service contract has priority over this warranty.

## 16. Disposal of the inverter



### Warning



Mandatory

- If you throw away the inverter, have it done by a specialist in industry waste disposal(\*). If you throw away the inverter by yourself, this can result in explosion of capacitor or produce noxious gases, resulting in injury.

(\* ) Persons who specialize in the processing of waste and known as "industrial waste product collectors and transporters" or "industrial waste disposal persons." If the collection, transport and disposal of industrial waste is done by someone who is not licensed for that job, it is a punishable violation of the law. (Laws in regard to cleaning and processing of waste materials)

For safety's sake, do not dispose of the disused inverter yourself but ask an industrial waste disposal agent.

Disposing of the inverter improperly could cause its capacitor to explode and emit toxic gas, causing injury to persons.

# TOSHIBA

**TOSHIBA CORPORATION**  
INDUSTRIAL AND POWER  
SYSTEMS & SERVICES COMPANY

OVERSEAS SALES & MARKETING DEPT.  
ELECTRICAL APPARATUS & MEASUREMENT DIV.

1-1, Shibaura 1-chome, Minato-Ku,  
Tokyo 105-8001, Japan  
TEL: +81-(0)3-3457-4911  
FAX: +81-(0)3-5444-9268

## TOSHIBA INTERNATIONAL CORPORATION

13131 West Little York RD., Houston,  
TX 77041, U.S.A  
TEL: +1-713-466-0277  
FAX: +1-713-896-5226

## TOSHIBA ASIA PACIFIC PTE., LTD

152 Beach Rd., #16-00 Gateway East,  
Singapore 189721  
TEL: +65-6297-0900  
FAX: +65-6297-5510

## TOSHIBA CHINA CO., LTD

23rd Floor, HSBC Tower, 101 Yin Cheng  
East Road, Pudong New Area, Shanghai  
200120, The People's Republic of China  
TEL: +86-(0)21-6841-5666  
FAX: +86-(0)21-6841-1161

## TOSHIBA INTERNATIONAL CORPORATION PTY., LTD

2 Morton Street Parramatta, NSW2150, Australia  
TEL: +61-(0)2-9768-6600  
FAX: +61-(0)2-9890-7542

## TOSHIBA INFORMATION, INDUSTRIAL AND POWER SYSTEMS TAIWAN CORP.

6F, No66, Sec1 Shin Sheng N.RD, Taipei, Taiwan  
TEL: +886-(0)2-2581-3639  
FAX: +886-(0)2-2581-3631

- For further information, please contact your nearest Toshiba Liaison Representative or International Operations - Producer Goods.
- The data given in this manual are subject to change without notice.